

INSTALLATION MANUAL

67452

ecolight

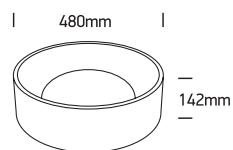

230V | SMD 2835 | 30W | IP20 | Aluminium

Complete with 500mA driver.

80
CRI

one
LIGHT

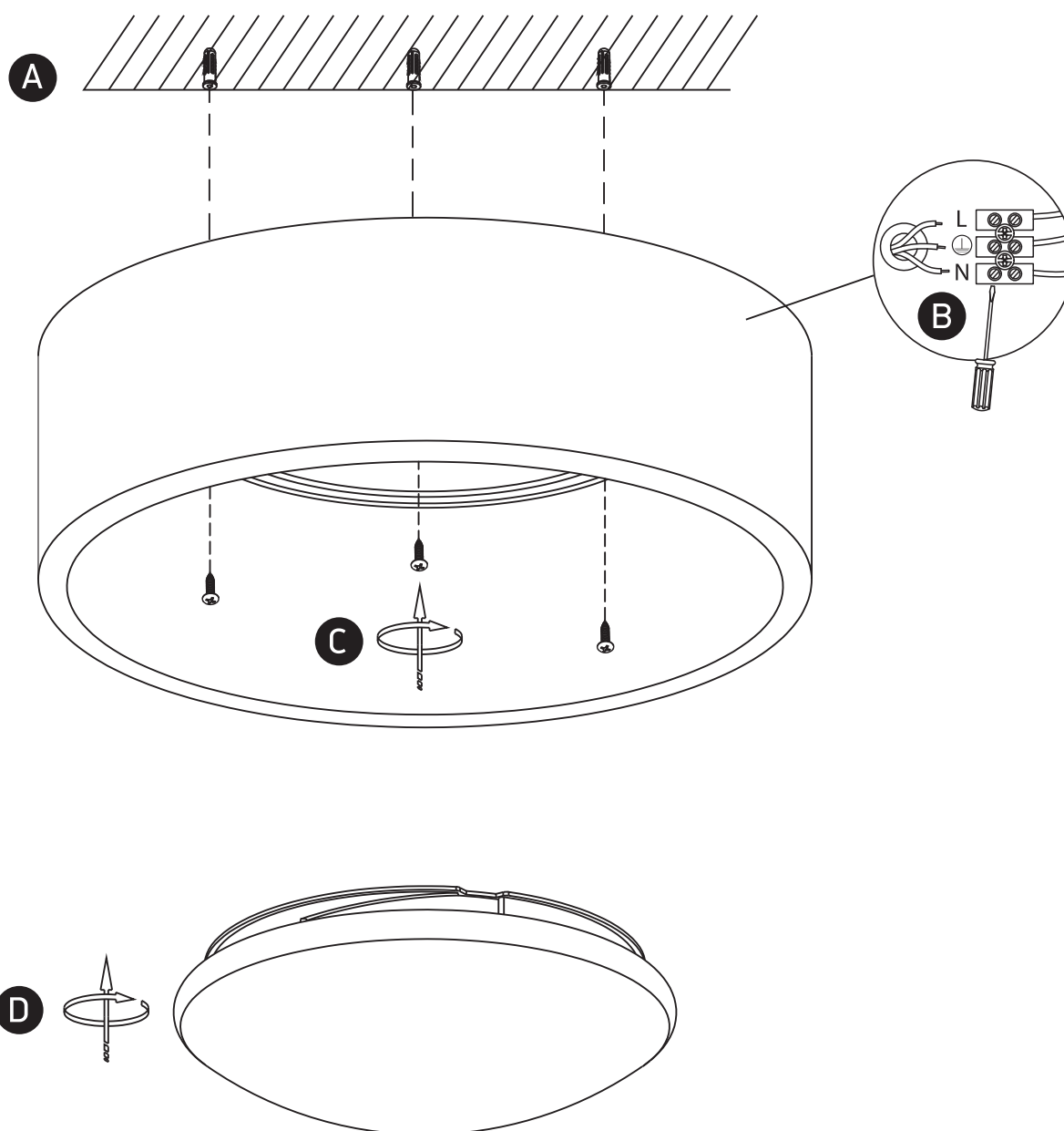

Warnings:

1. Fix the base on the ceiling.
2. Make sure that the product is installed properly before connecting to electricity.
3. Connect the AC power cable to the driver's cable as shown in the above diagram.
4. Do not cover the fitting.
5. Maintenance and installation should only be carried out by a professional electrician.