

INSTALLATION MANUAL

67426A

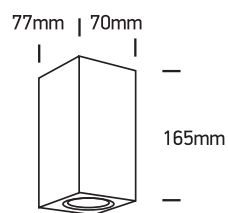

100-240V | MR16 | GU10 | 2x7W | IP65 | Die cast



one
LIGHT

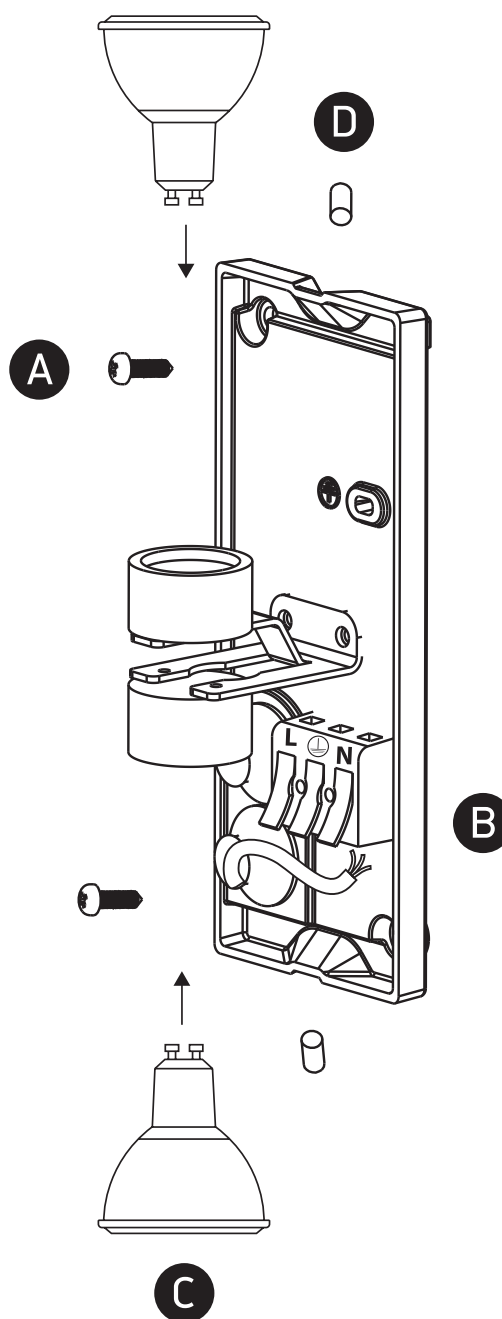
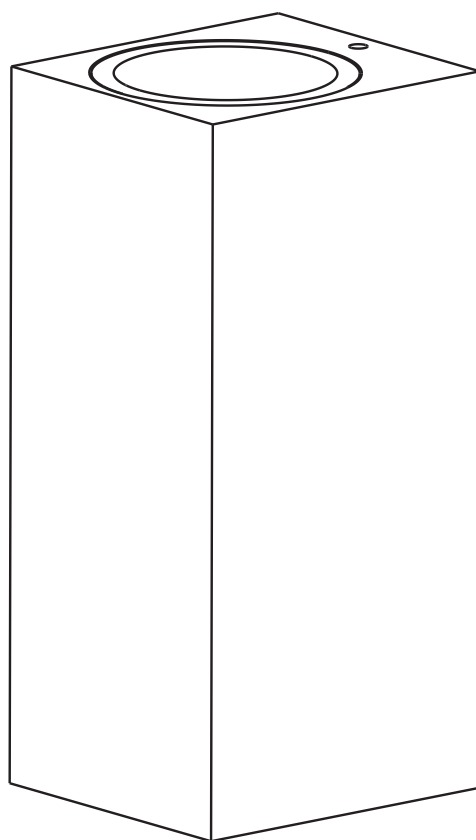

Warnings:

1. Make sure that the product is installed properly before connecting to electricity.
2. Do not cover the fitting.
3. Maintenance and installation should only be carried out by a professional electrician.