

INSTALLATION MANUAL

67162

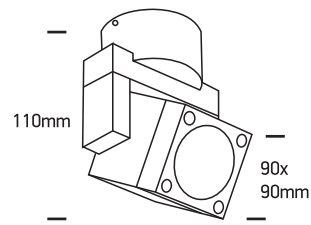

100-240V | MR16 | GU10 | 35W | IP54 | Aluminium | Adjustable



one
LIGHT

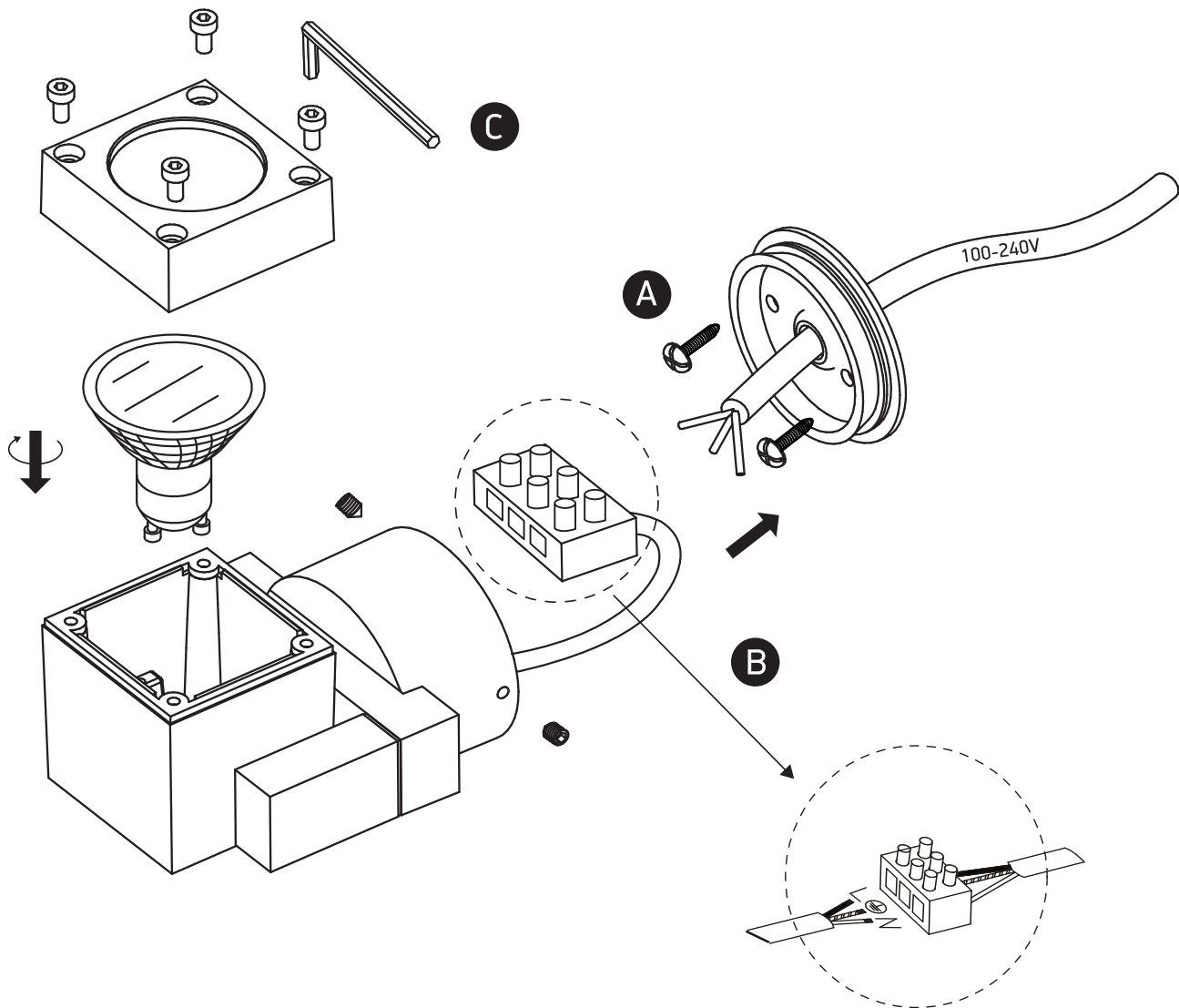

Warnings:

1. Make sure that the product is installed properly before connecting to electricity.
2. Do not cover the fitting.
3. Maintenance and installation should only be carried out by a professional electrician.