

INSTALLATION MANUAL

61096

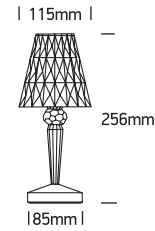

1,2W | IP54 | SMD LED | Touch | Dimmable | Plastic

Rechargeable USB socket.
1x2000mAh lithium battery.80
CRI
one
LIGHT

A CHARGE

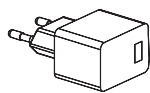
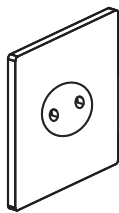
Order separately
USB adaptor
61000A

USB

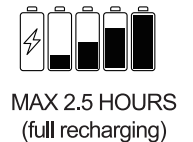
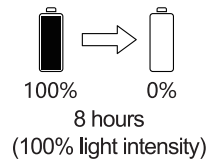
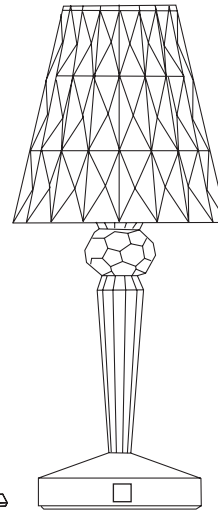

B 3 - STEP DIMMABLE

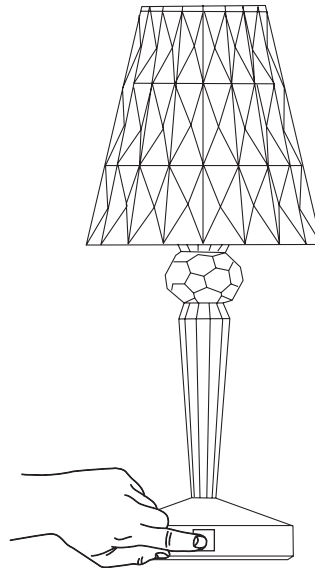
Touch the button to switch ON/OFF the
light and keep touching in order to dim it.
(100% - 50% - 25%)

Warnings:

1. Do not cover the fitting.
2. The batteries should not be opened, destroyed or incinerate.
3. Do not short circuit terminals, or over charge the battery, forced over-discharge, throw to fire.
4. Do not crush or puncture the battery, or immerse in liquids.
5. Avoid direct sunlight.
6. Storage preferably in cool, dry and ventilated area, which is subject to little temperature change.
7. Do not place the battery near heating equipment, nor expose to direct sunlight for long periods.