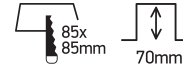
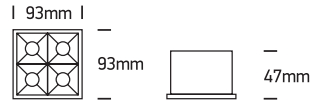
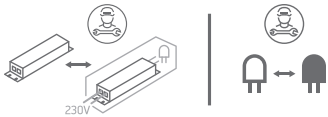
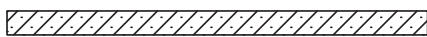
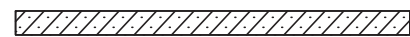
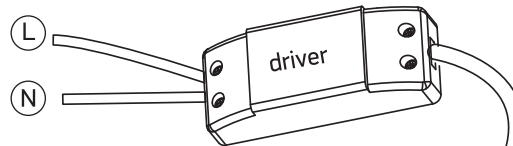
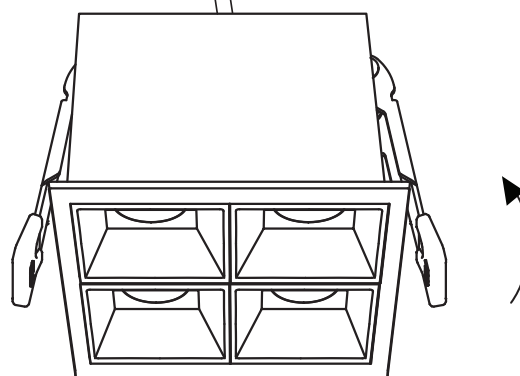

INSTALLATION MANUAL

50406B

ecolight

**90
CRI**

230V | COB LED | 16W | IP20 | Die cast
Complete with 400mA driver.

one
L I G H T

A

B

C

Warnings:

1. Make sure that the product is installed properly before connecting to electricity.
2. Do not cover the fitting.
3. Maintenance and installation should only be carried out by a professional electrician.