

# INSTALLATION MANUAL

## 50302B

**ecolight**



90  
CRI



700mA | LED | 3x2W | IP20 | Die cast

Use 89008A driver.

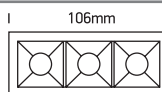

**one**  
LIGHT

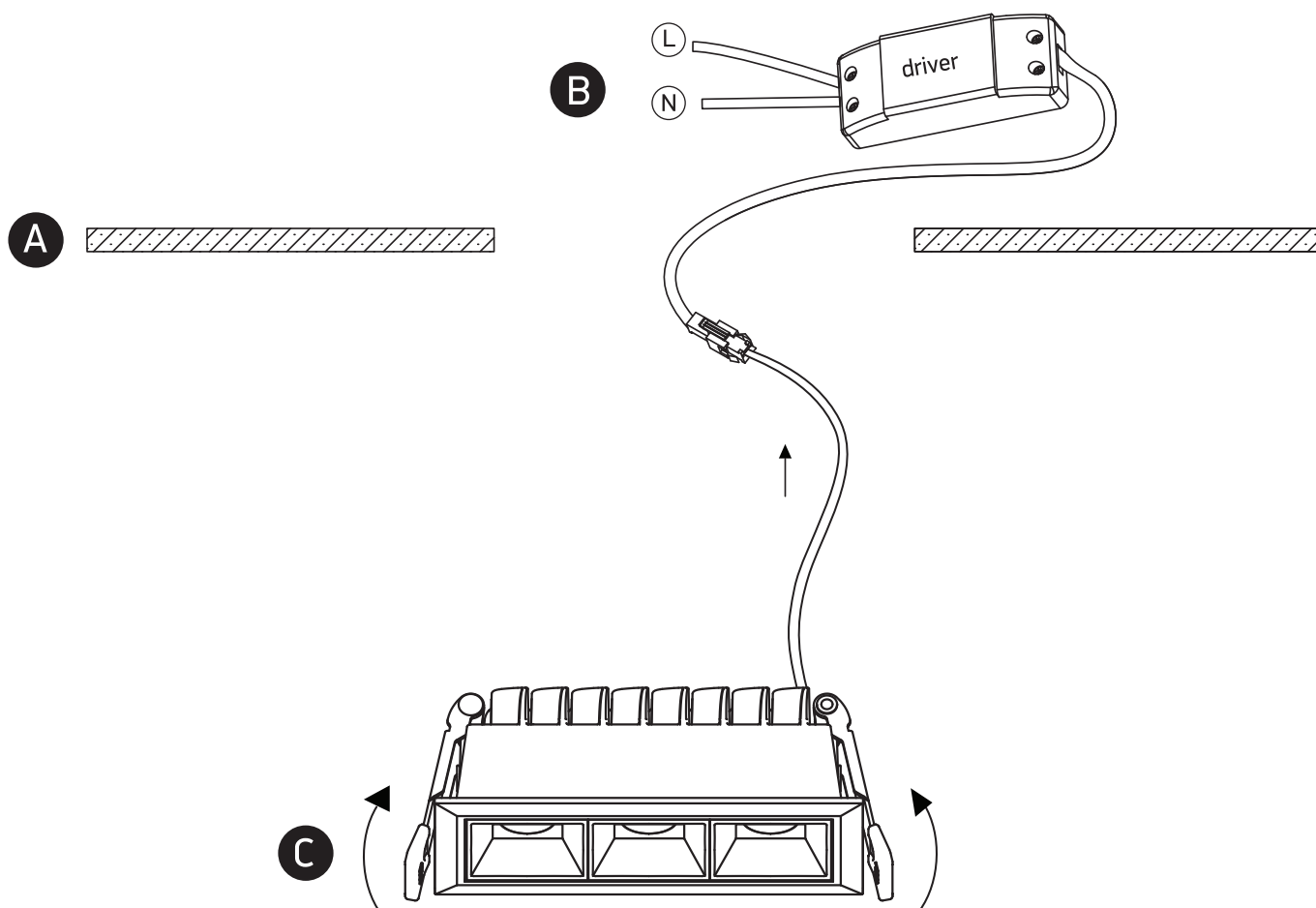

### Warnings:

1. Make sure that the product is installed properly before connecting to electricity.
2. Do not cover the fitting.
3. Maintenance and installation should only be carried out by a professional electrician.