

INSTALLATION MANUAL

50130UV

LED BUILT IN    UGR19

CE ENEC UK CA   

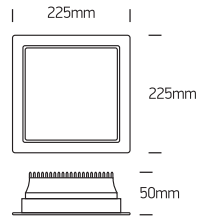

230V | SMD 2835 | 30W | IP44 | Adjustable CCT | Die cast
Complete with 750mA driver.

80 CRI

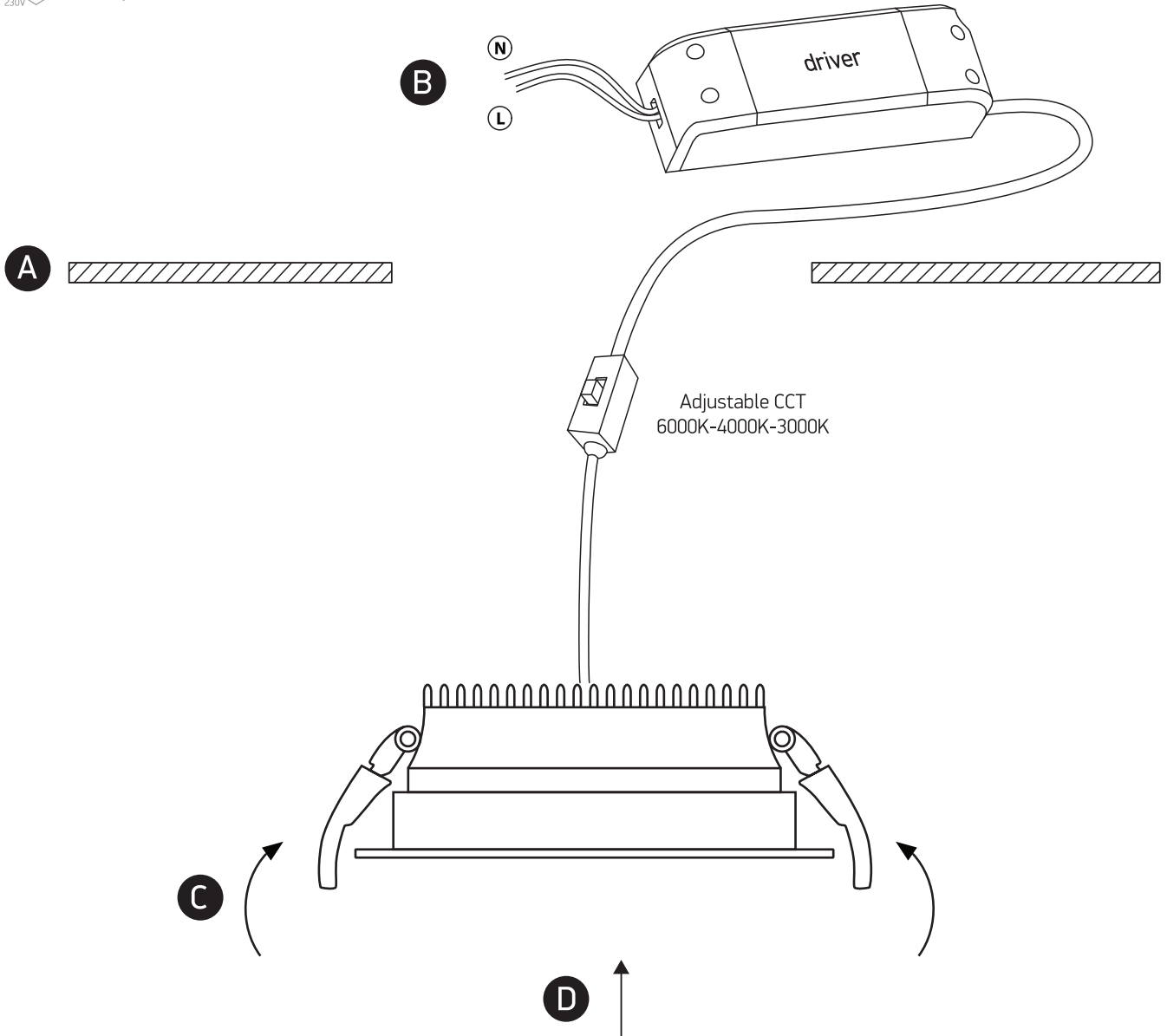
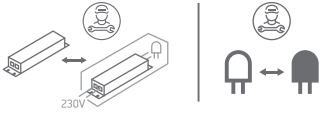

Warnings:

1. Make sure that the product is installed properly before connecting to electricity.
2. Do not cover the fitting.
3. Maintenance and installation should only be carried out by a professional electrician.