

INSTALLATION MANUAL

50130B

ecodownlight

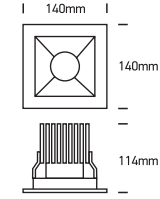

230V | 30W | IP20 | Aluminium + metal
Complete with 750mA driver.

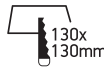

80
CRI

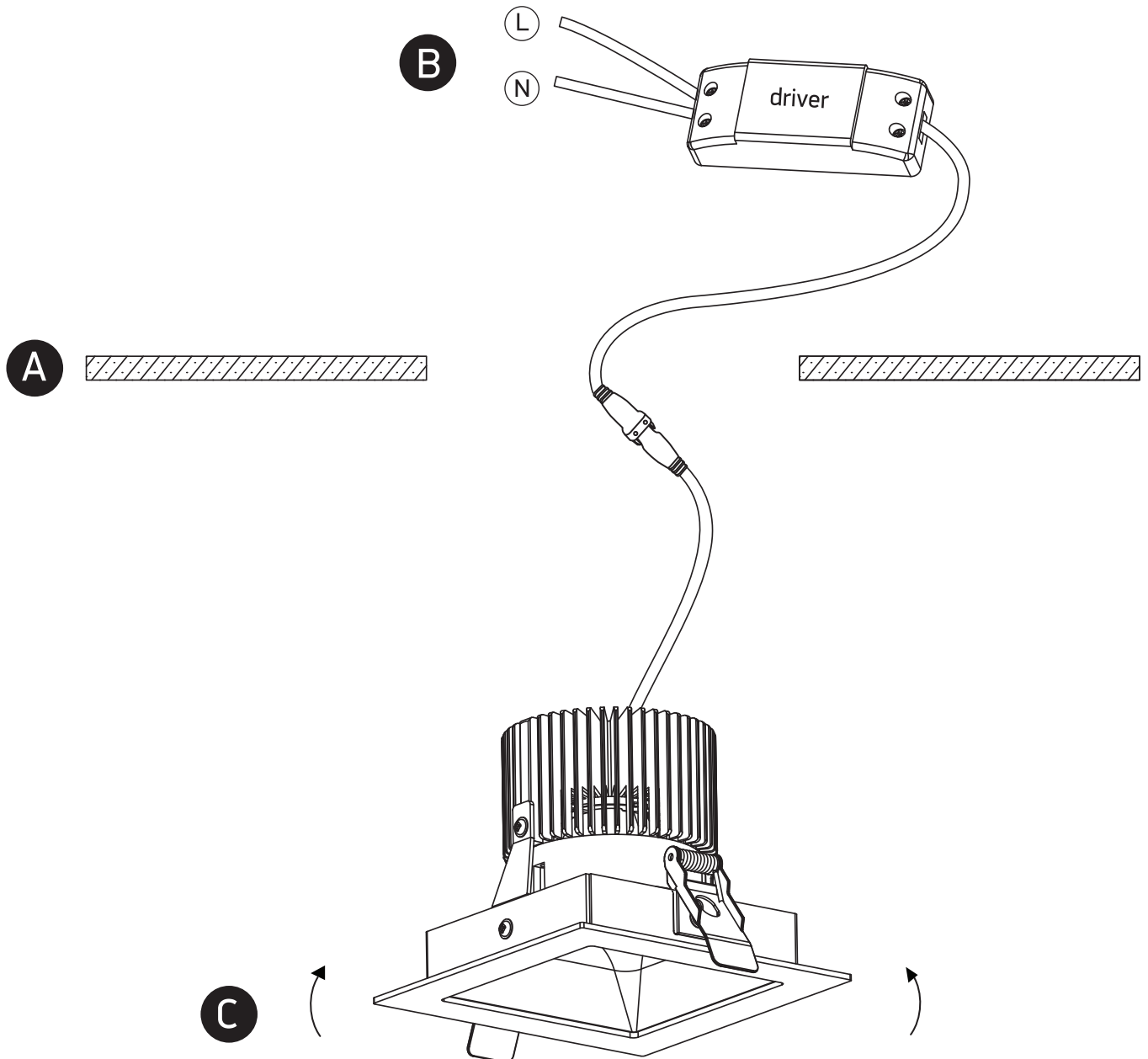

Warnings:

1. Make sure that the product is installed properly before connecting to electricity.
2. Do not cover the fitting.
3. Maintenance and installation should only be carried out by a professional electrician.