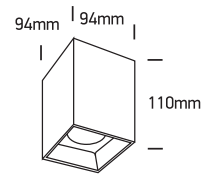

INSTALLATION MANUAL

12120ZA

ecolight

 DARK
LIGHT

230V | 20W | IP20 | Die cast + plastic reflector

Complete with driver.

 80
CRI

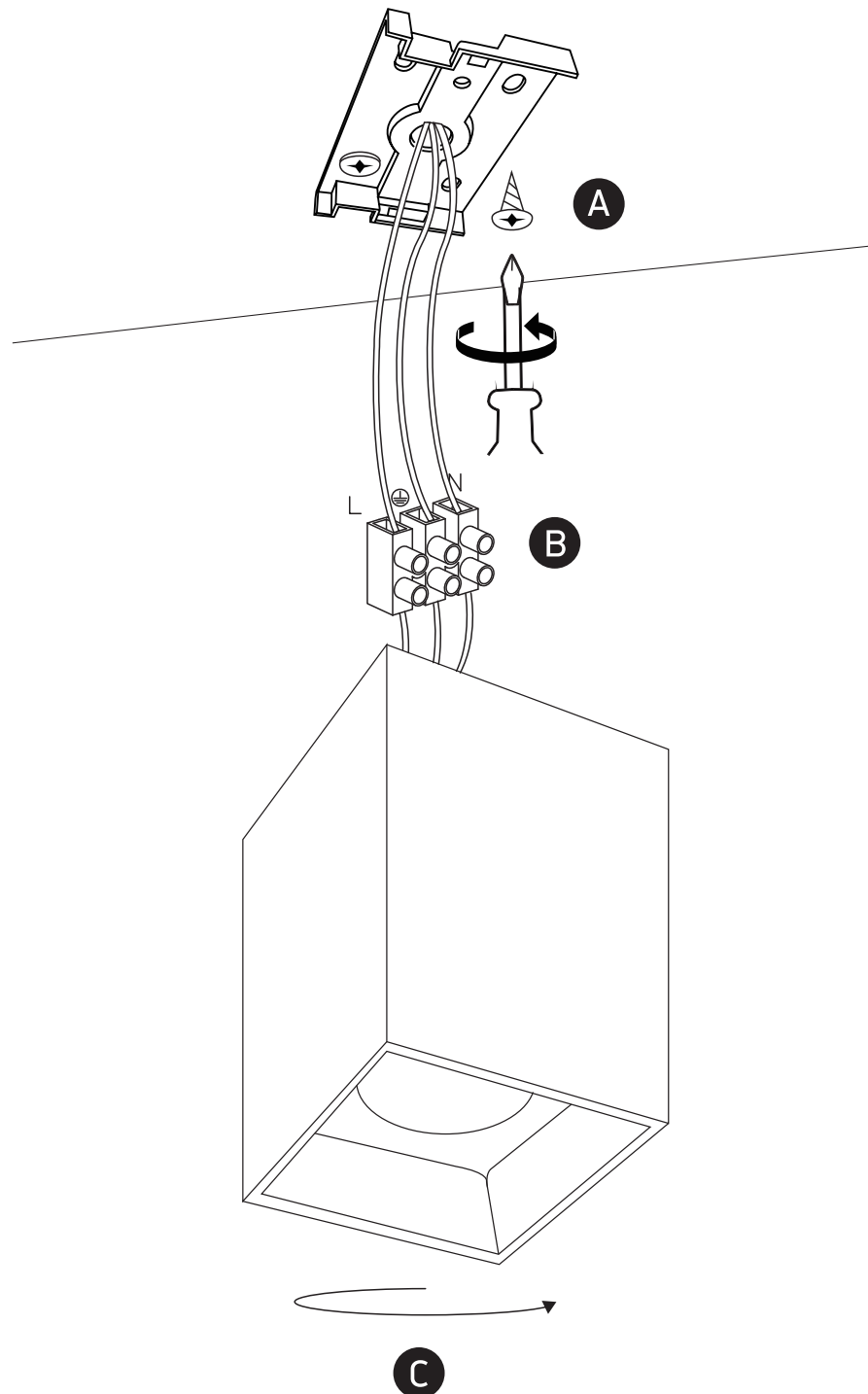
one
LIGHT

Warnings:

1. Make sure that the product is installed properly before connecting to electricity.
2. Do not cover the fitting.
3. Maintenance and installation should only be carried out by a professional electrician.