

# INSTALLATION MANUAL

## 10115CD

**ecodownlight**



Ra>80

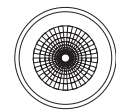

170mm

230V | 15W | IP20 | Die cast

Complete with driver.



75mm

**one**  
LIGHT

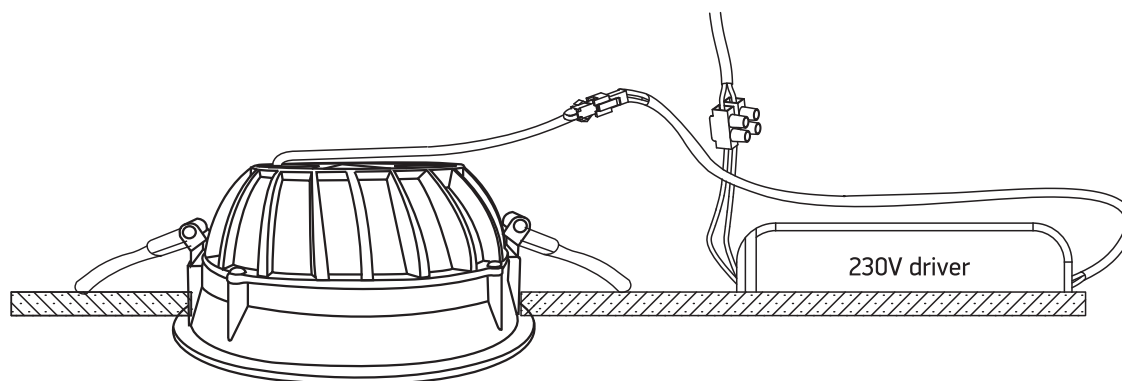
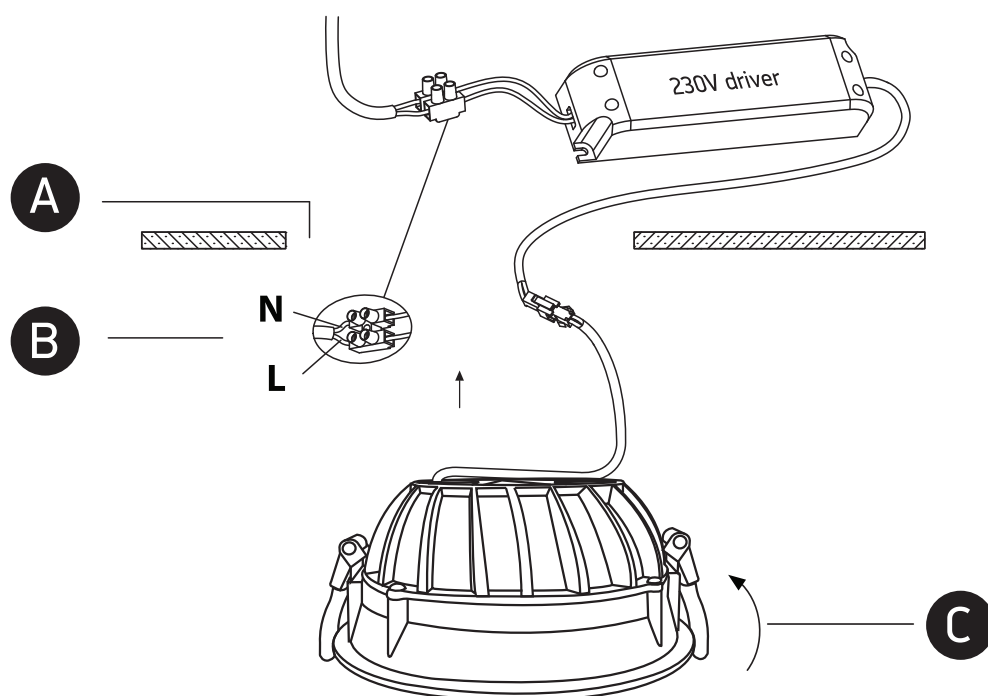

### Warnings:

1. Make sure that the product is installed properly before connecting to electricity.
2. Do not cover the fitting.
3. Maintenance and installation should only be carried out by a professional electrician.