

INSTALLATION MANUAL

12112A

LED
BUILT IN



DARK
LIGHT

CE EAC UK CA

RoHS
COMPLIANT



NOT
DIMMABLE

230V | COB LED | 10W+2W | IP20 | Aluminium
Complete with 300mA driver.

90
CRI

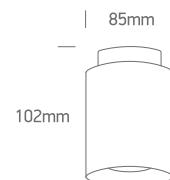

one
LIGHT

A

CUT OUT : $\phi 25\text{mm}$

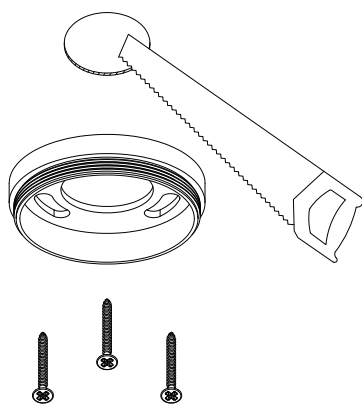

B

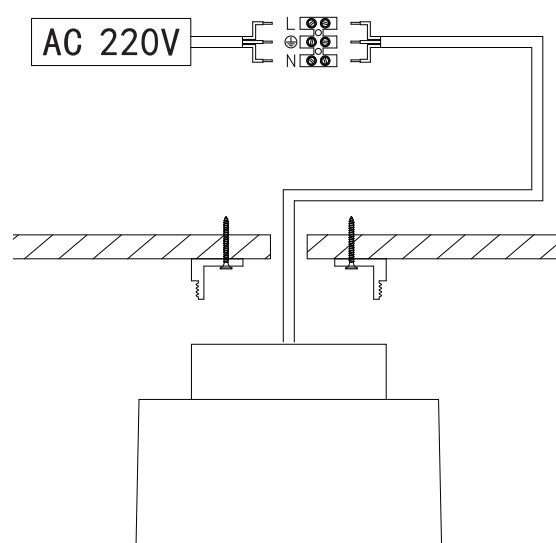

C

LOCK

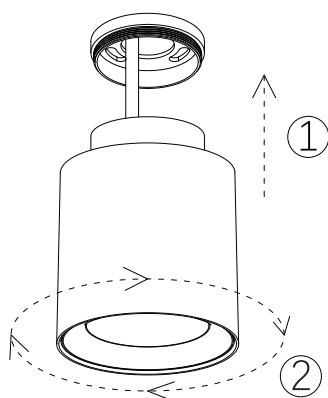

D

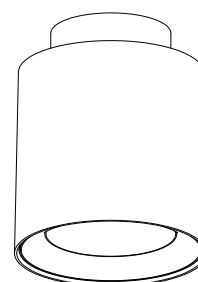

Warnings:

1. Make sure that the product is installed properly before connecting to electricity.
2. Do not cover the fitting.
3. Maintenance and installation should only be carried out by a professional electrician.