

INSTALLATION MANUAL

10124

ecodownlight



238mm

230V | SMD 2835 | 24W | IP44 | Aluminium
Complete with driver.

80
CRI



100mm

one
LIGHT

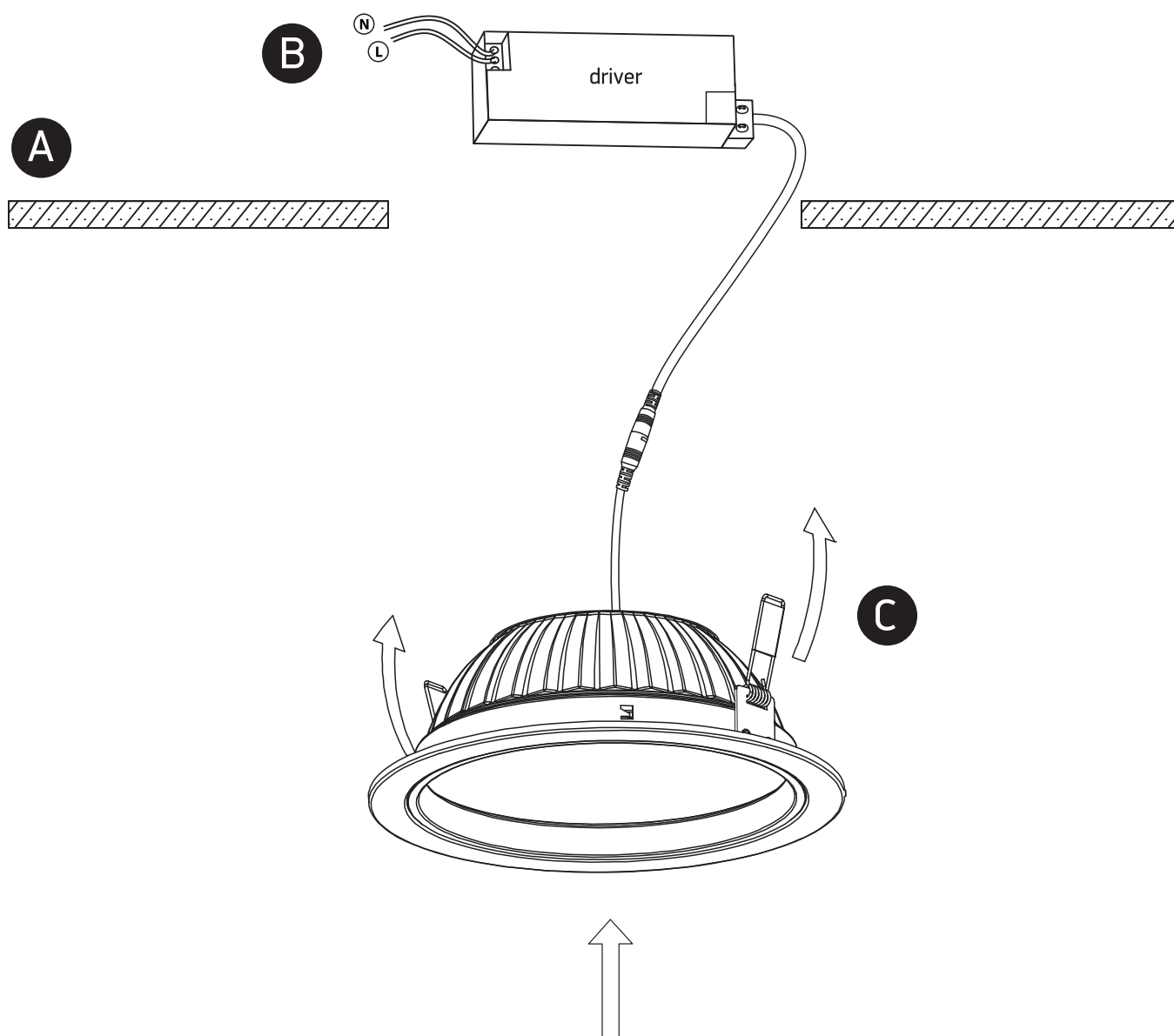

Warnings:

1. Make sure that the product is installed properly before connecting to electricity.
2. Do not cover the fitting.
3. Maintenance and installation should only be carried out by a professional electrician.