

INSTALLATION MANUAL

10112P

ecolight



83mm

700mA | COB LED | 12W | IP65 | Die cast

Requires 700mA driver.



90
CRI

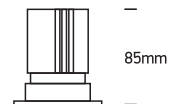

85mm

one
LIGHT

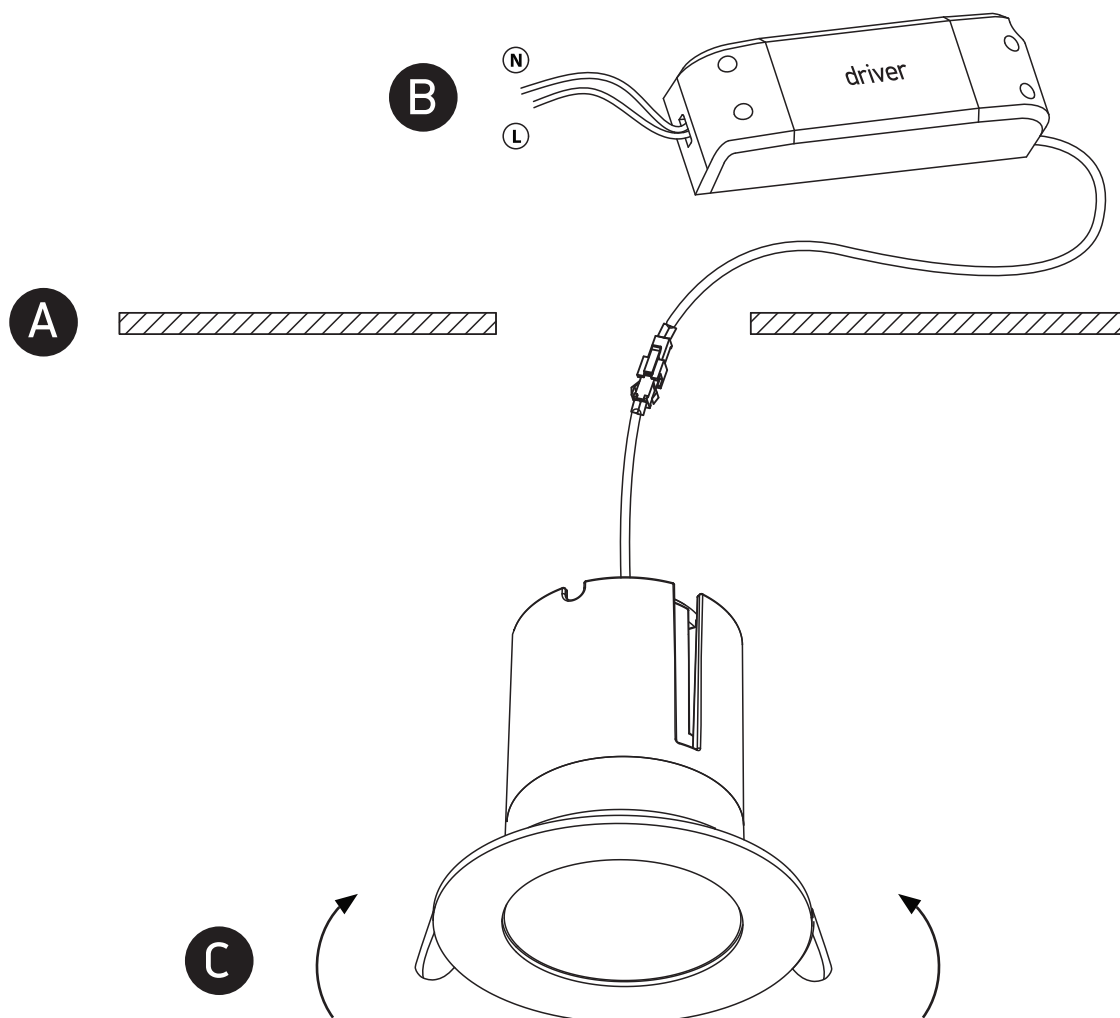

Warnings:

1. Make sure that the product is installed properly before connecting to electricity.
2. Do not cover the fitting.
3. Maintenance and installation should only be carried out by a professional electrician.