

INSTALLATION MANUAL

10112HA

ecolight

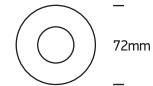

700mA | COB LED | 12W | IP20 | Die cast
Requires 700mA driver.

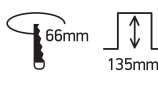

90 CRI

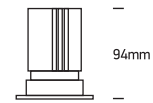

one
LIGHT

Order separately:

050182 - Ring

050182R - Round base

050182RA - Square base

050182RB - Double square base

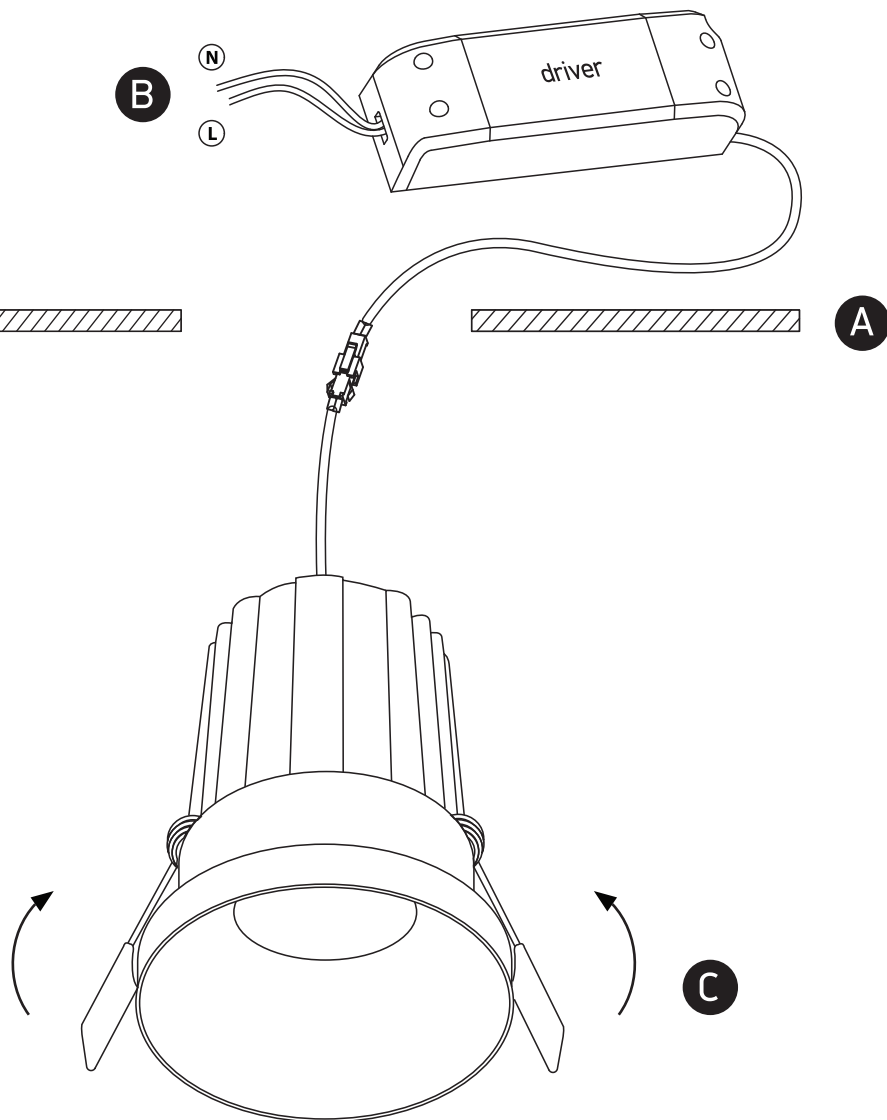
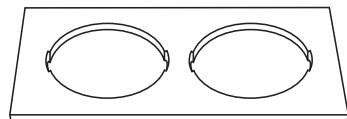
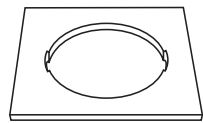
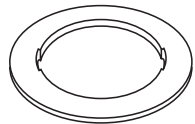
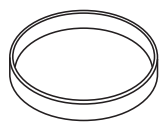

Warnings:

1. Make sure that the product is installed properly before connecting to electricity.
2. Do not cover the fitting.
3. Maintenance and installation should only be carried out by a professional electrician.