

INSTALLATION MANUAL

10110P

ecolight

85mm

700mA | COB LED | 12W | IP65 | Die cast
Requires 700mA driver.

90 CRI

80mm

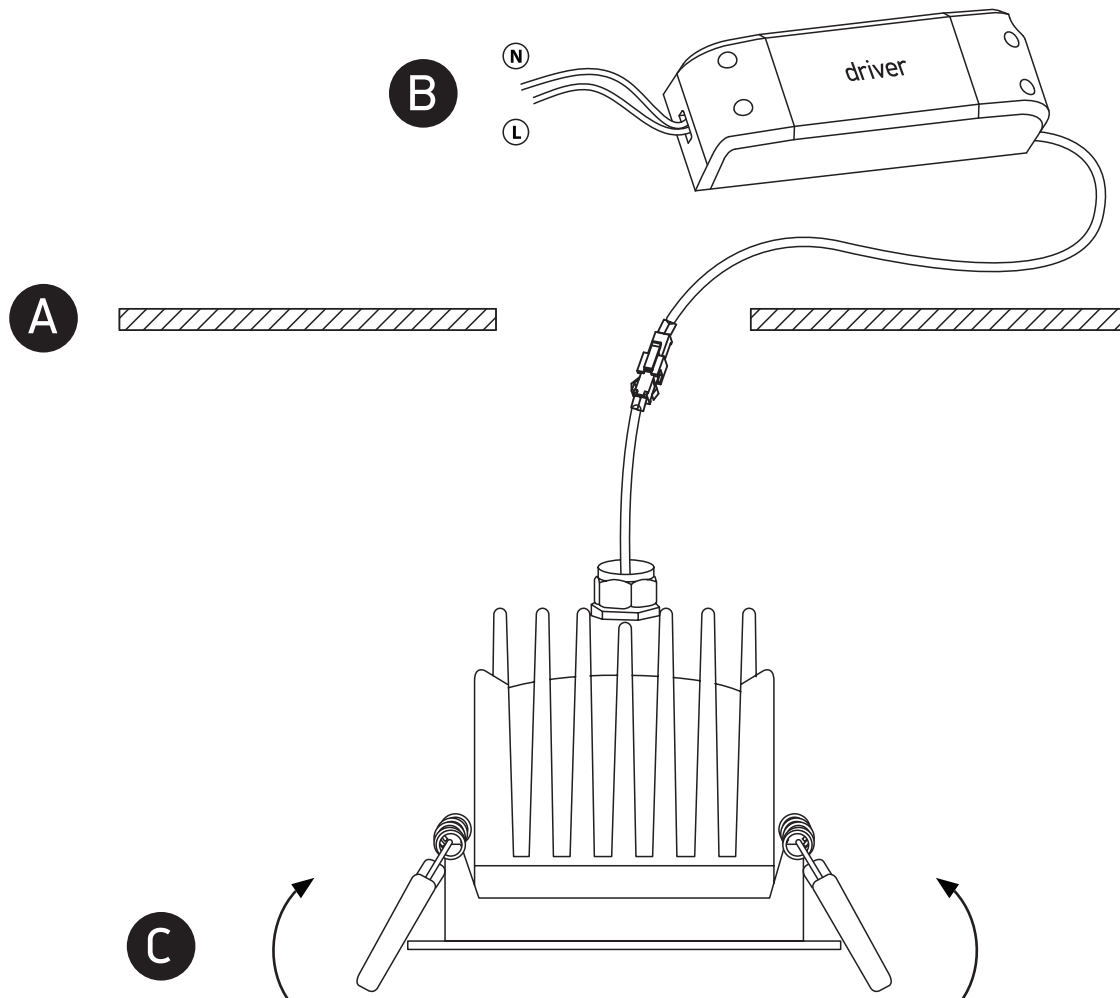
one
LIGHT

Warnings:

1. Make sure that the product is installed properly before connecting to electricity.
2. Do not cover the fitting.
3. Maintenance and installation should only be carried out by a professional electrician.