

INSTALLATION MANUAL

10109D

ecolight



CE

RoHS
COMPLIANT



80
CRI

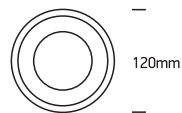

120mm

230V | SMD 2835 | 9W | IP20 | Die cast
Complete with 300mA driver.

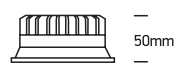
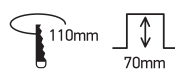
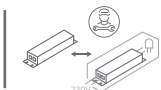

50mm

one
LIGHT

A

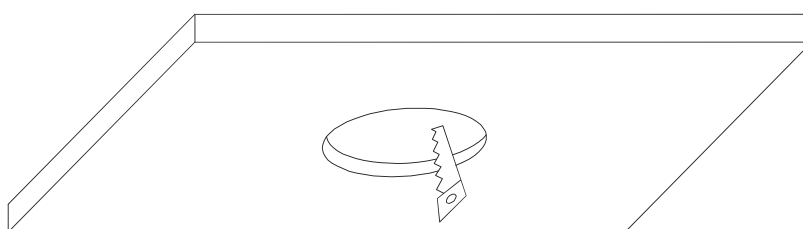

CUTOUT HOLE: 110mm

B

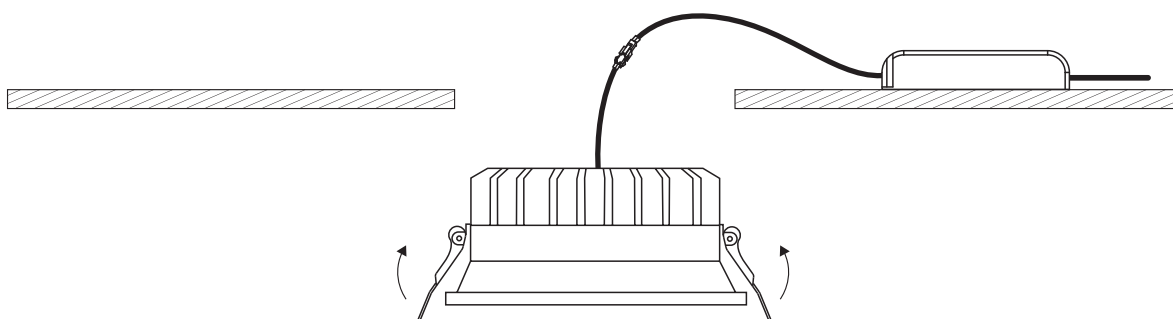

C

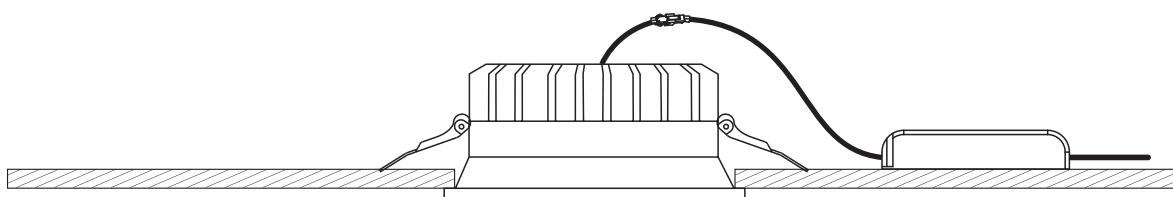

*IP54 is the protection degree of the fitting under the ceiling. The fitting part hidden in the ceiling is IP20

Warnings:

1. Make sure that the product is installed properly before connecting to electricity.
2. Do not cover the fitting.
3. Maintenance and installation should only be carried out by a professional electrician.