

## Niloé™ Step Cover plates

Cat. No(s): 8 641 61/71/72/73/74/75 - 8 643 61/71/72/73/74/75  
 8 645 61/71/72/73/74/75 - 8 646 61/71/72/73/74/75  
 8 647 71/72/73/74/75 - 8 648 71/72/73/74/75  
 8 649 71/72/73/74/75

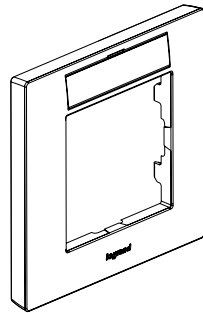

8 64X 61

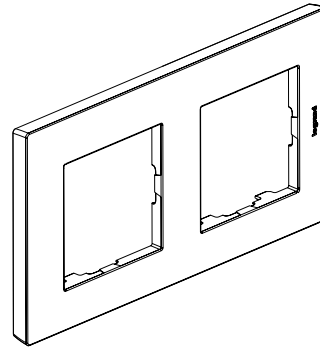

8 64X 72

### 1. USE

Faceplates for Niloé Step from 1 to 5 gangs wiring accessories.  
 Available in several colours.

### 2. RANGE

#### 1-gang plates

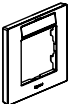
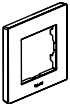
	1-gang plate with label holder ○ White ● Aluminium ● Black ● Sand	8 641 61 8 643 61 8 645 61 8 646 61
	○ White ● Aluminium ● Black ● Sand ● Copper ● Brushed aluminium ● Dark wood	8 641 71 8 643 71 8 645 71 8 646 71 8 647 71 8 648 71 8 649 71

#### 2-gang plates

71 mm spacing - horizontal and vertical

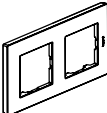
	○ White ● Aluminium ● Black ● Sand ● Copper ● Brushed aluminium ● Dark wood	8 641 72 8 643 72 8 645 72 8 646 72 8 647 72 8 648 72 8 649 72
---	---	--

### 2. RANGE (continued)

#### 3-gang plates

71 mm spacing - horizontal and vertical

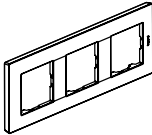
	○ White ● Aluminium ● Black ● Sand ● Copper ● Brushed aluminium ● Dark wood	8 641 73 8 643 73 8 645 73 8 646 73 8 647 73 8 648 73 8 649 73
--	---	--

#### 4-gang plates

71 mm spacing - horizontal and vertical

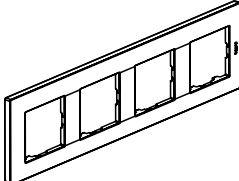
	○ White ● Aluminium ● Black ● Sand ● Copper ● Brushed aluminium ● Dark wood	8 641 74 8 643 74 8 645 74 8 646 74 8 647 74 8 648 74 8 649 74
--	---	--

#### 5-gang plates

71 mm spacing - horizontal and vertical

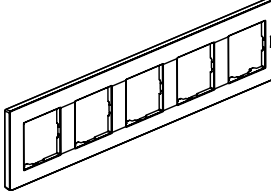
	○ White ● Aluminium ● Black ● Sand ● Copper ● Brushed aluminium ● Dark wood	8 641 75 8 643 75 8 645 75 8 646 75 8 647 75 8 648 75 8 649 75
--	---	--

# Niloé™ Step Cover plates

Cat. No(s): 8 641 61/71/72/73/74/75 - 8 643 61/71/72/73/74/75  
8 645 61/71/72/73/74/75 - 8 646 61/71/72/73/74/75  
8 647 71/72/73/74/75 - 8 648 71/72/73/74/75  
8 649 71/72/73/74/75

## 3. OVERALL DIMENSIONS (mm)

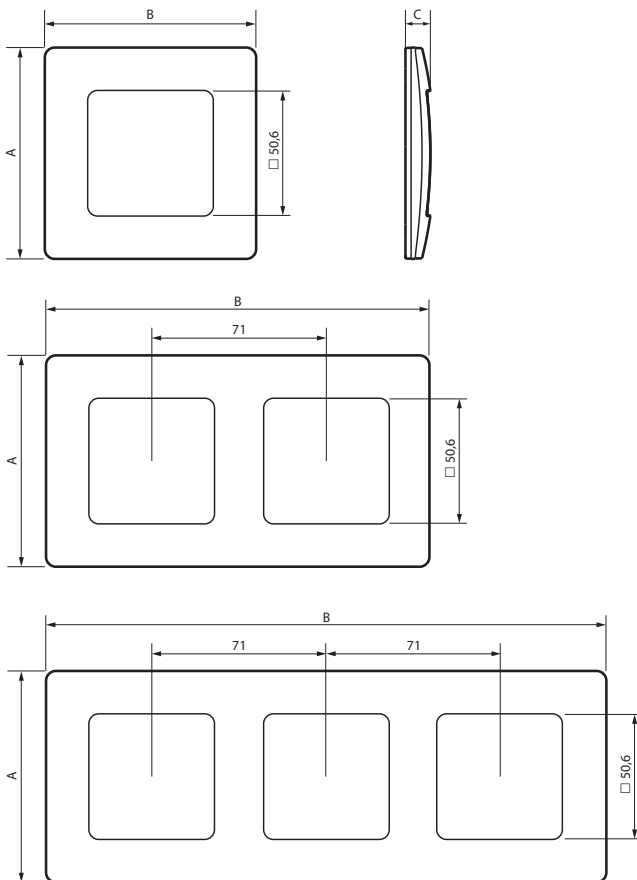

	A	B	C
1-gang	86	86	10
2-gang 71 mm fixing centres	86	157	10
3-gang 71 mm fixing centres	86	228	10
4-gang 71 mm fixing centres	86	299	10
5-gang 71 mm fixing centres	86	370	10

## 4. TECHNICAL CHARACTERISTICS

### ■ 4.1 Materials

Matt surface appearance

Material: - ABS plate

- Halogen-free

- UV resistant

Self-extinguishing:

+ 850°C/30 s for insulating parts holding live parts in place

+ 650°C/30 s for other parts made of insulating materials

### ■ 4.2 Climatic characteristics

Storage and usage temperature: - 5°C to + 35°C

## 5. CLEANING

Clean the surface with a cloth.

Do not use acetone, tar-removing cleaning agents or trichloroethylene.

**Caution:** An initial test is required for the use of other special maintenance products.