

Niloé™ Step Cover plates

Cat. No(s): 8 630 91/92/93/94/95 - 8 631 91/92/93/94/95 - 8 632 91/92/93/94/95
 8 633 91/92/93/94/95 - 8 634 91/92/93/94/95 - 8 635 91/92/93/94/95
 8 636 91/92/93/94/95 - 8 637 91/92/93/94/95 - 8 638 91/92/93/94/95
 8 639 91/92/93/94/95

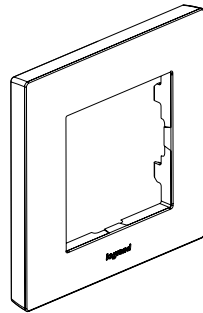

8 63X 91

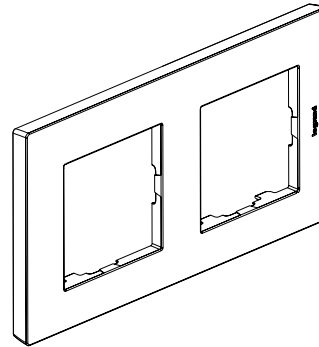

8 63X 92

1. USE

Faceplates for Niloé Step from 1 to 5 gangs wiring accessories.
 Available in several colours.

2. RANGE

1-gang plates

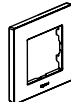
	Atoll	8 630 91
	White	8 631 91
	Old pink	8 632 91
	Aluminium	8 633 91
	Medium grey	8 634 91
	Black	8 635 91
	Pearl	8 636 91
	Dark grey	8 637 91
	Brushed aluminium	8 638 91
	Brushed medium grey	8 649 91

2-gang plates

71 mm spacing - horizontal and vertical

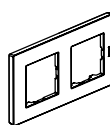
	Atoll	8 630 92
	White	8 631 92
	Old pink	8 632 92
	Aluminium	8 633 92
	Medium grey	8 634 92
	Black	8 635 92
	Pearl	8 636 92
	Dark grey	8 637 92
	Brushed aluminium	8 638 92
	Brushed medium grey	8 649 92

2. RANGE (continued)

3-gang plates

71 mm spacing - horizontal and vertical

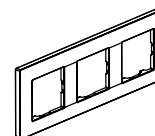
	Atoll	8 630 93
	White	8 631 93
	Old pink	8 632 93
	Aluminium	8 633 93
	Medium grey	8 634 93
	Black	8 635 93
	Pearl	8 636 93
	Dark grey	8 637 93
	Brushed aluminium	8 638 93
	Brushed medium grey	8 649 93

4-gang plates

71 mm spacing - horizontal and vertical

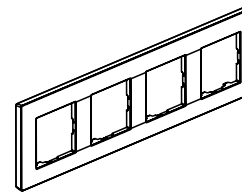
	Atoll	8 630 94
	White	8 631 94
	Old pink	8 632 94
	Aluminium	8 633 94
	Medium grey	8 634 94
	Black	8 635 94
	Pearl	8 636 94
	Dark grey	8 637 94
	Brushed aluminium	8 638 94
	Brushed medium grey	8 649 94

5-gang plates

71 mm spacing - horizontal and vertical

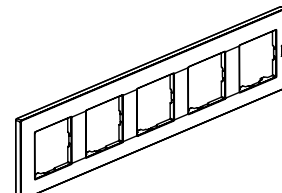
	Atoll	8 630 95
	White	8 631 95
	Old pink	8 632 95
	Aluminium	8 633 95
	Medium grey	8 634 95
	Black	8 635 95
	Pearl	8 636 95
	Dark grey	8 637 95
	Brushed aluminium	8 638 95
	Brushed medium grey	8 649 95

Niloé™ Step Cover plates

Cat. No(s): 8 630 91/92/93/94/95 - 8 631 91/92/93/94/95 - 8 632 91/92/93/94/95
8 633 91/92/93/94/95 - 8 634 91/92/93/94/95 - 8 635 91/92/93/94/95
8 636 91/92/93/94/95 - 8 637 91/92/93/94/95 - 8 638 91/92/93/94/95
8 639 91/92/93/94/95

3. OVERALL DIMENSIONS (mm)

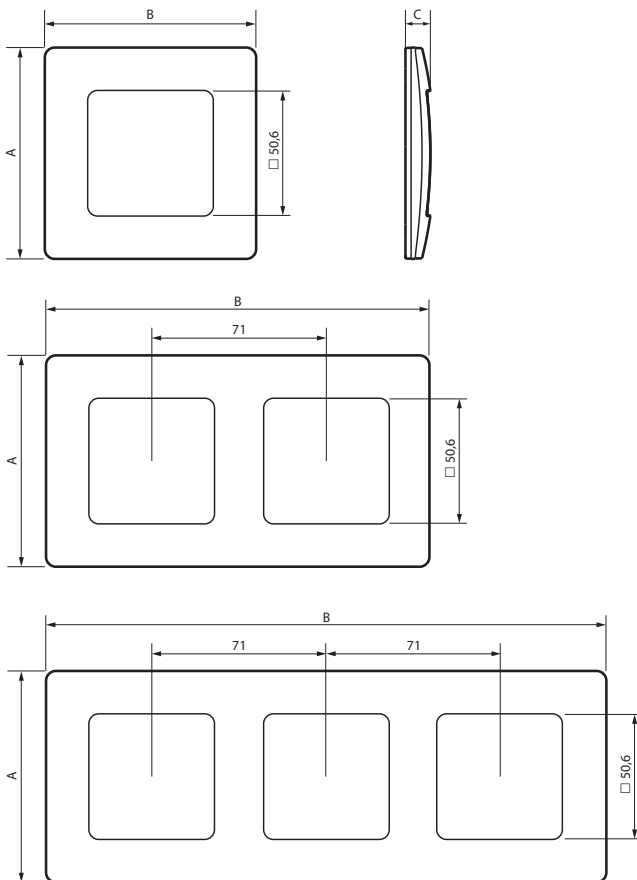

	A	B	C
1-gang	86	86	10
2-gang 71 mm fixing centres	86	157	10
3-gang 71 mm fixing centres	86	228	10
4-gang 71 mm fixing centres	86	299	10
5-gang 71 mm fixing centres	86	370	10

4. TECHNICAL CHARACTERISTICS

■ 4.1 Materials

Matt surface appearance

Material: - ABS plate

- Halogen-free

- UV resistant

Self-extinguishing:

+ 850°C/30 s for insulating parts holding live parts in place

+ 650°C/30 s for other parts made of insulating materials

■ 4.2 Climatic characteristics

Storage and usage temperature: - 5°C to + 35°C

5. CLEANING

Clean the surface with a cloth.

Do not use acetone, tar-removing cleaning agents or trichloroethylene.

Caution: An initial test is required for the use of other special maintenance products.