

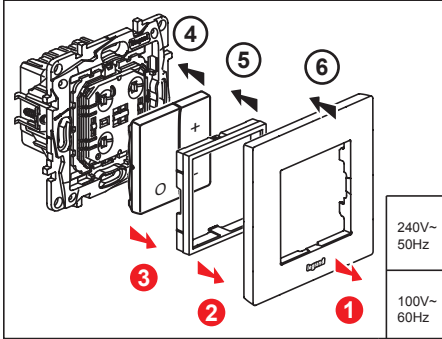

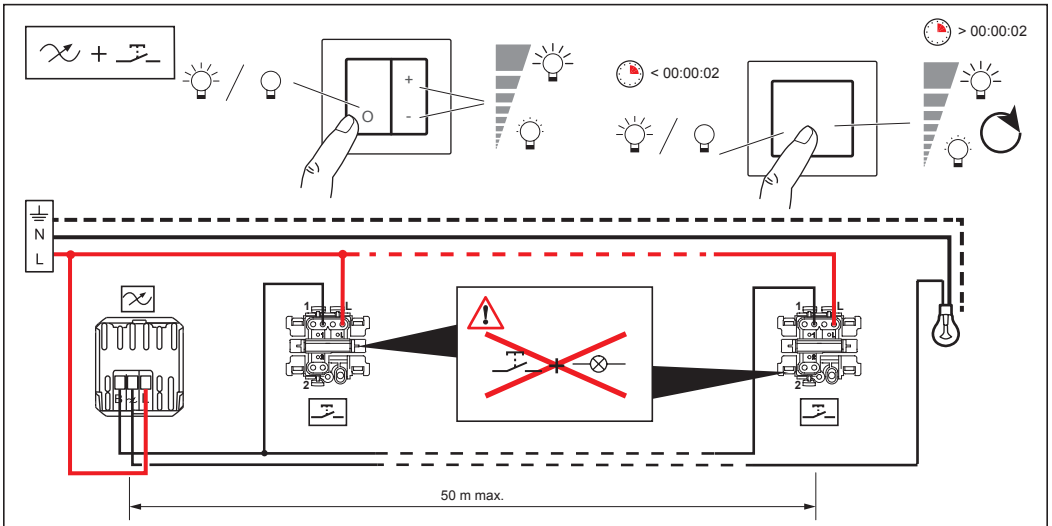

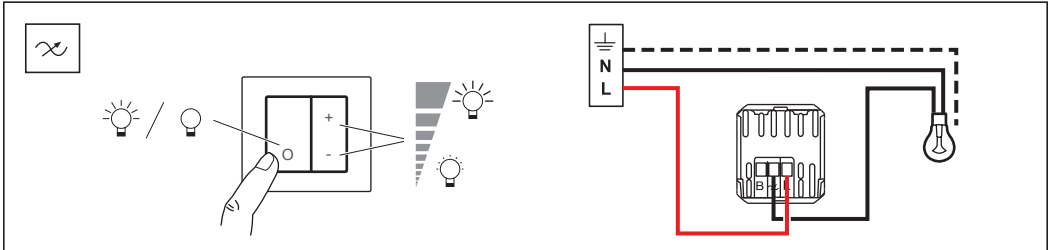

			U / f	
-10°C ... +70°C	-5°C ... +40°C	40 mm	100 ... 240 V~ 50 / 60 Hz	8 mm 1...2.5 mm ²

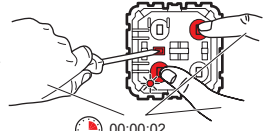
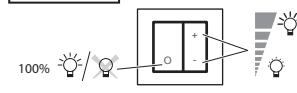
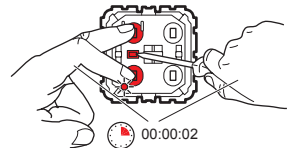
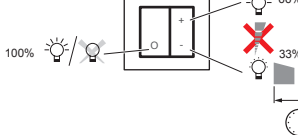
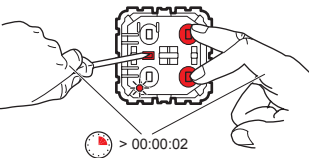
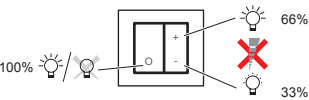
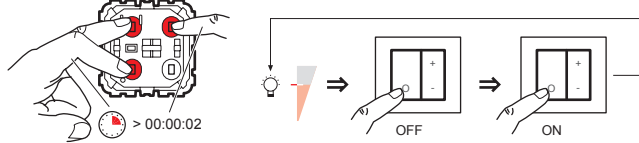
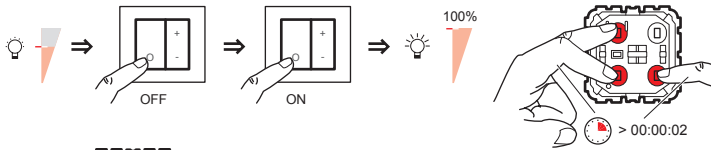
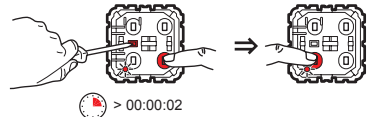
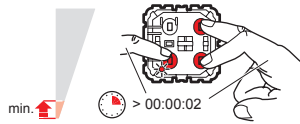
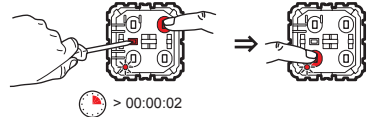
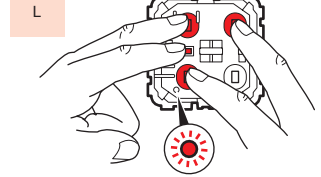
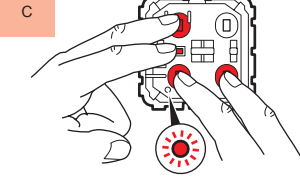
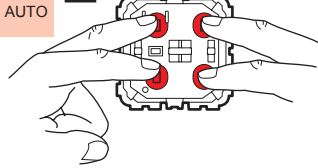
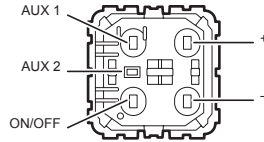
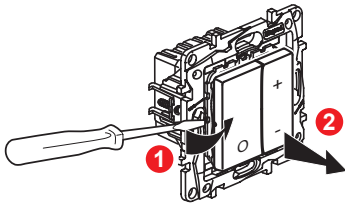

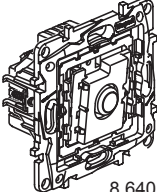





	R	L	CIL		Dimmable	Dimmable LED
240V~ 50Hz	3 ... 400 W	3 ... 400 VA	3 ... 200 VA	3 ... 400 VA	3 ... 200 VA	3 ... 75 W ≤ 10 x
100V~ 60Hz	3 ... 200 W	3 ... 200 VA	3 ... 100 VA	3 ... 200 VA	3 ... 100 VA	3 ... 37 W ≤ 10 x



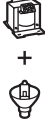

 <p>8 640 09</p>				<p>U / f</p>	
	<p>-10°C ... +70°C</p>	<p>-5°C ... +40°C</p>	<p>40 mm</p>	<p>240 V~ 50 / 60 Hz</p>	 <p>8 mm</p> <p>1,5 mm²</p>

 <p>00:10</p>	R		L	C/L			
							
<p>230 V</p>	<p>Max. 150 W</p>	<p>150 W</p>	<p>150 VA</p>	<p>150 VA</p>	<p>100VA</p>	<p>650 mA</p>	<p>650 mA</p>
	<p>Min. 12 W</p>	<p>12 W</p>	<p>12 VA</p>	<p>12 VA</p>	<p>12 VA</p>	<p>50 mA</p>	<p>50 mA</p>

