

 -5°C ... +40°C	 U, f, I	100 W max. LED
 -10°C ... +70°C	40 mm 250 V~ 50 / 60 Hz 6 A	 12 mm 1...2,5 mm <sup>2</sup>

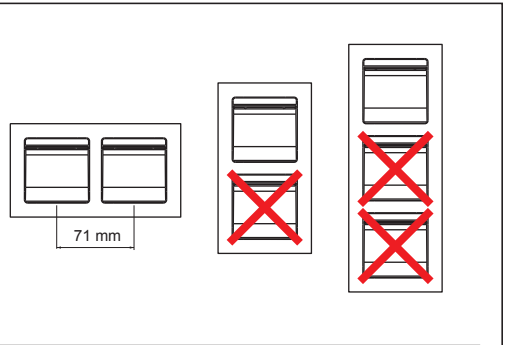

8 631 46, 8 633 46, 8 634 46, 8 635 46, 8 640 15

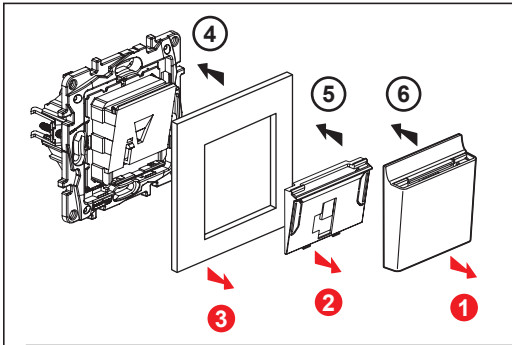
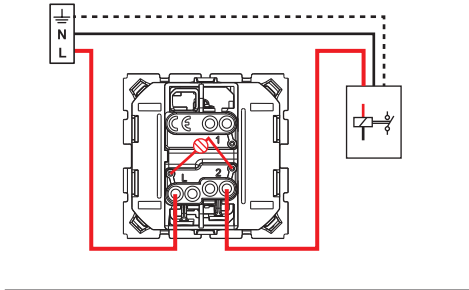

8 640 14

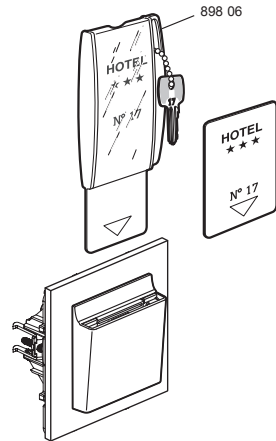
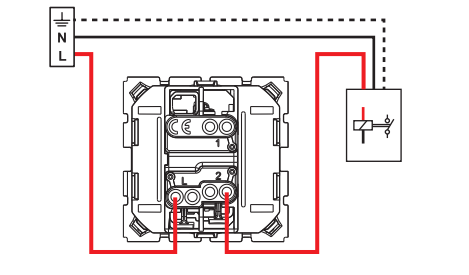

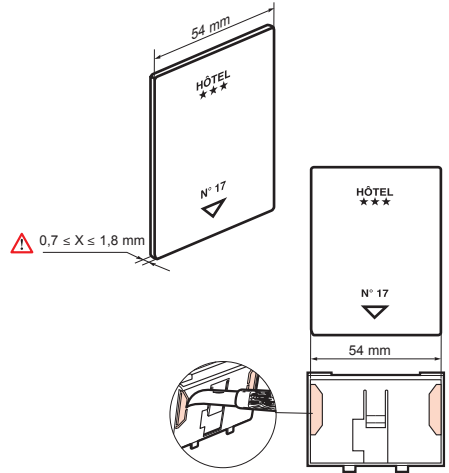
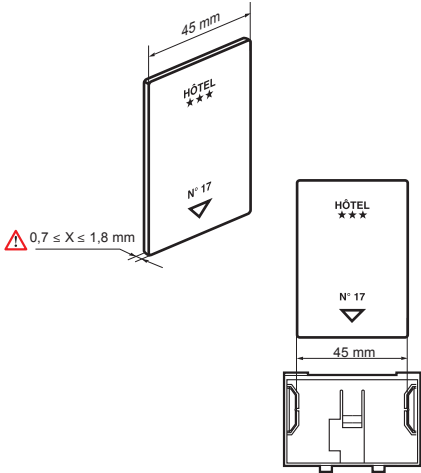

8 640 14

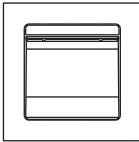

8 631 46  
8 633 46  
8 634 46  
8 635 46  
8 640 15

