

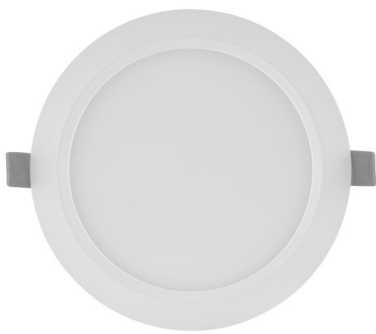

PRODUCT DATASHEET

DOWNLIGHT LED SLIM ROUND 24 W 4000 K IP44

DOWNLIGHT SLIM ROUND | Flat downlights with external driver and aluminum housing



AREAS OF APPLICATION

- Direct replacement for luminaires with compact fluorescent lamps
- Public areas
- Stairways
- Corridors
- Foyers
- Shops
- Bathrooms
- Kitchens

PRODUCT BENEFITS

- Very slim housing
- Low installation depth
- High luminous efficacy
- Energy savings up to 60 % (compared to luminaires that use CFL lamps)
- Very homogenous light
- Functional design
- External driver for extended flexibility
- 2 years guarantee

PRODUCT FEATURES

- Small visible bezel
- Robust die-cast aluminum housing
- Type of protection: IP44



TECHNICAL DATA

Electrical data

Nominal wattage	24.00 W
Operating mode	External LED driver
Nominal voltage	220...240 V
Power factor λ	> 0.50
Mains frequency	50/60 Hz

Photometrical data

Color temperature	4000 K
Luminous flux	1920 lm
Luminous efficacy	80 lm/W
Standard deviation of color matching	<6 sdc _m
Color rendering index Ra	>80

Light technical data

Beam angle	120 °
------------	-------

Dimensions & weight

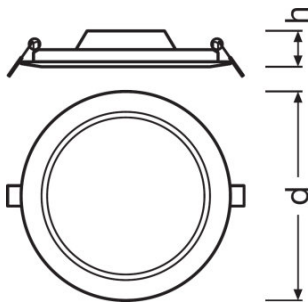

Diameter	300.0 mm
Height	23.0 mm
Product weight	600.00 g
Cable length	100 mm

Colors & materials

Body material	Aluminum
Housing color	White
Product color	White
Cover material	Polystyrene (PS)

Temperatures & operating conditions

Ambient temperature range	-10...+50 °C
----------------------------------	--------------

Lifespan

Lifespan L70 at 25 °C	15000 h
------------------------------	---------

Additional product data

Mounting type	Recessed
Mounting location	Ceiling

Capabilities

Dimmable	No
LED module replaceable	Not replaceable

Certificates & standards

Protection class	II
Type of protection	IP44
Standards	EAC

LOGISTICAL DATA

Product code	Packaging unit (Pieces/Unit)	Dimensions (length x width x height)	Gross weight	Volume
4058075154506	Folding carton box 1	305 mm x 47 mm x 305 mm	742.00 g	4.37 dm ³
4058075154513	Shipping carton box 10	478 mm x 316 mm x 324 mm	8038.00 g	48.94 dm ³

The mentioned product code describes the smallest quantity unit which can be ordered. One shipping unit can contain one or more single products. When placing an order, for the quantity please enter single or multiples of a shipping unit.

REFERENCES / LINKS

Further information see

- ▶ www.ledvance.com/services-and-tools/services/downloads/downloadcenter-for-professionell-clients

For Guarantee see

- ▶ www.ledvance.com/guarantee

DISCLAIMER

Subject to change without notice. Errors and omission excepted. Always make sure to use the most recent release.