

# ideal lux®

## Equinoxe SP1 D25

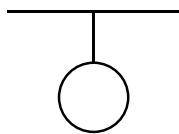

Lampada a sospensione  
 Suspension lamp  
 Suspension  
 Pendelleuchte  
 Lámpara colgante  
 Люстры и подвесы



max 1 x 2W G4 LED/ 220~240V 50/60Hz  
 - 8021696306551 CROMO  
 - 8021696277394 OTTONE

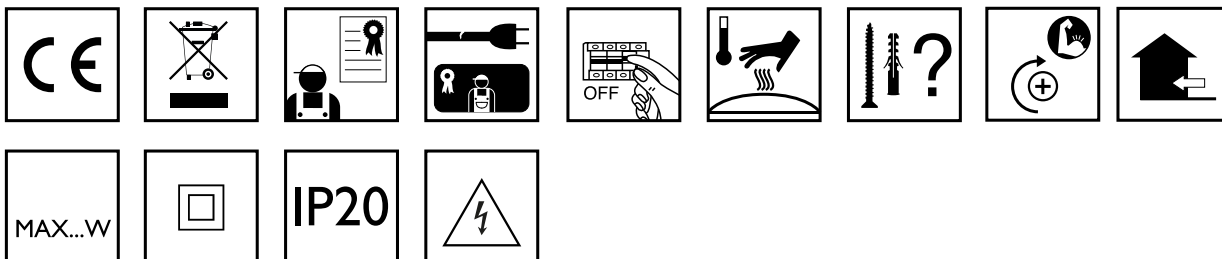
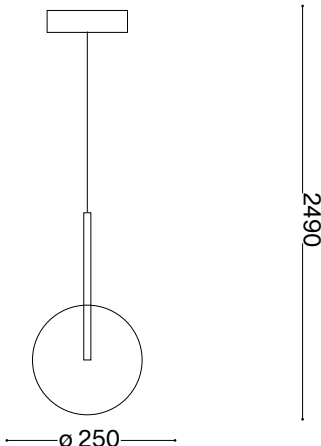

ESEGUIRE LE OPERAZIONI SEGUENDO L'ORDINE PROGRESSIVO. L'INSTALLAZIONE DI QUESTO APPARECCHIO DEVE ESSERE EFFETTUATA DA PERSONALE QUALIFICATO.  
 FOLLOW THE ASSEMBLY INSTRUCTIONS BY READING THE NUMERICAL PROGRESSION. THE LIGHTING FITTING SHOULD BE INSTALLED BY A QUALIFIED ELECTRICIAN.

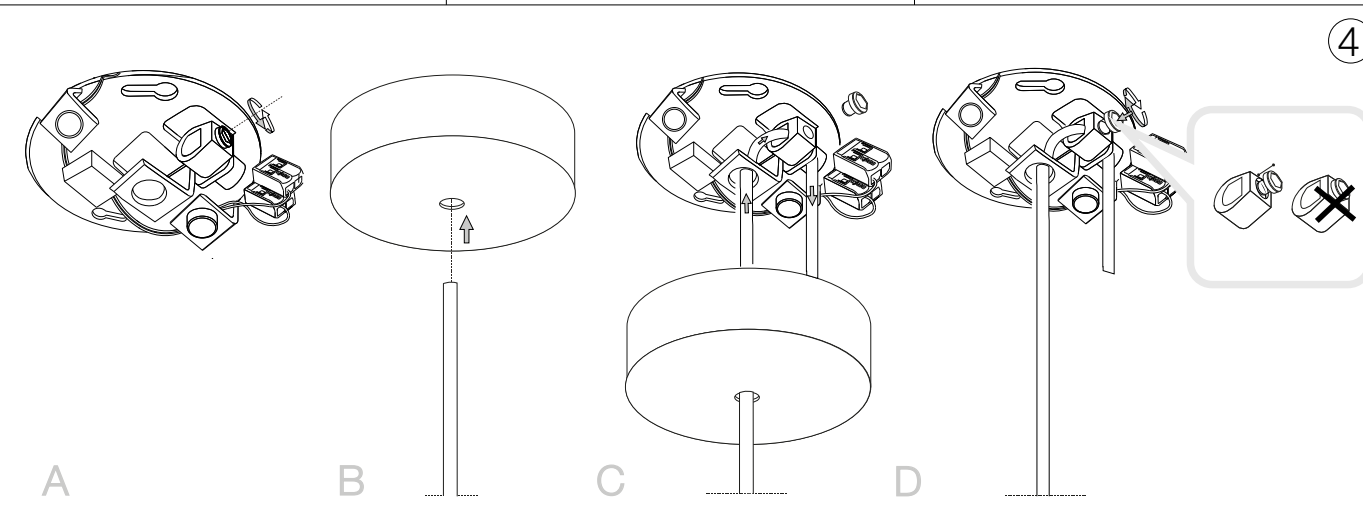
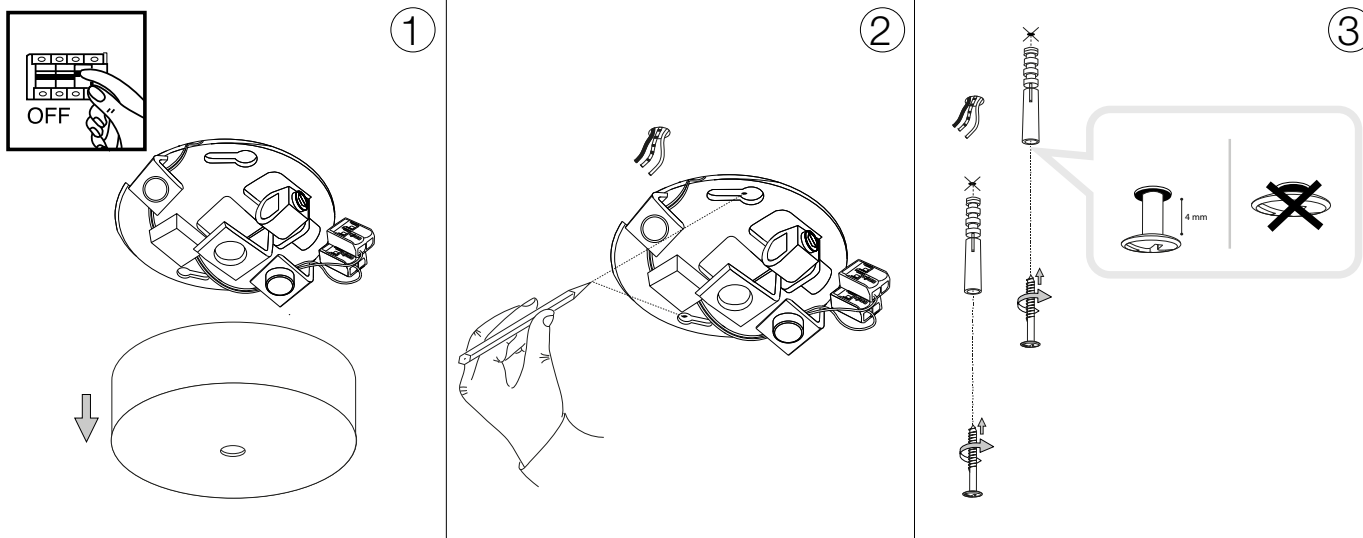

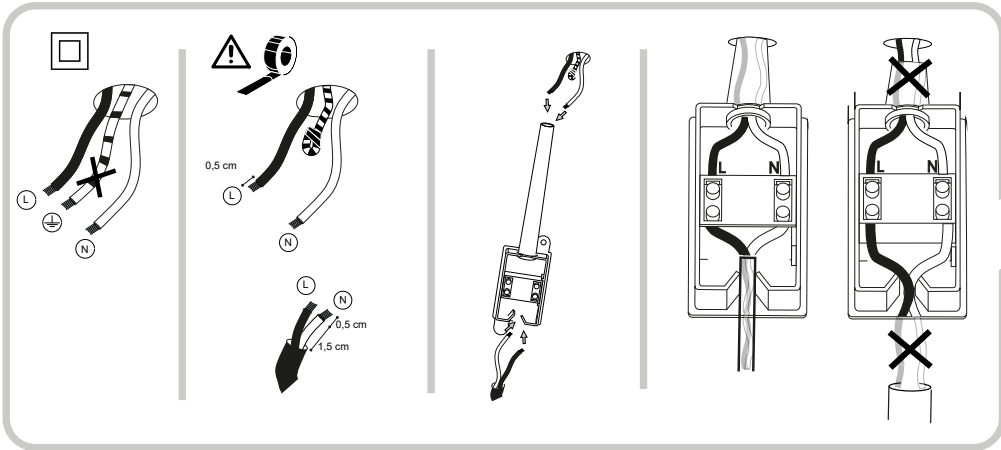
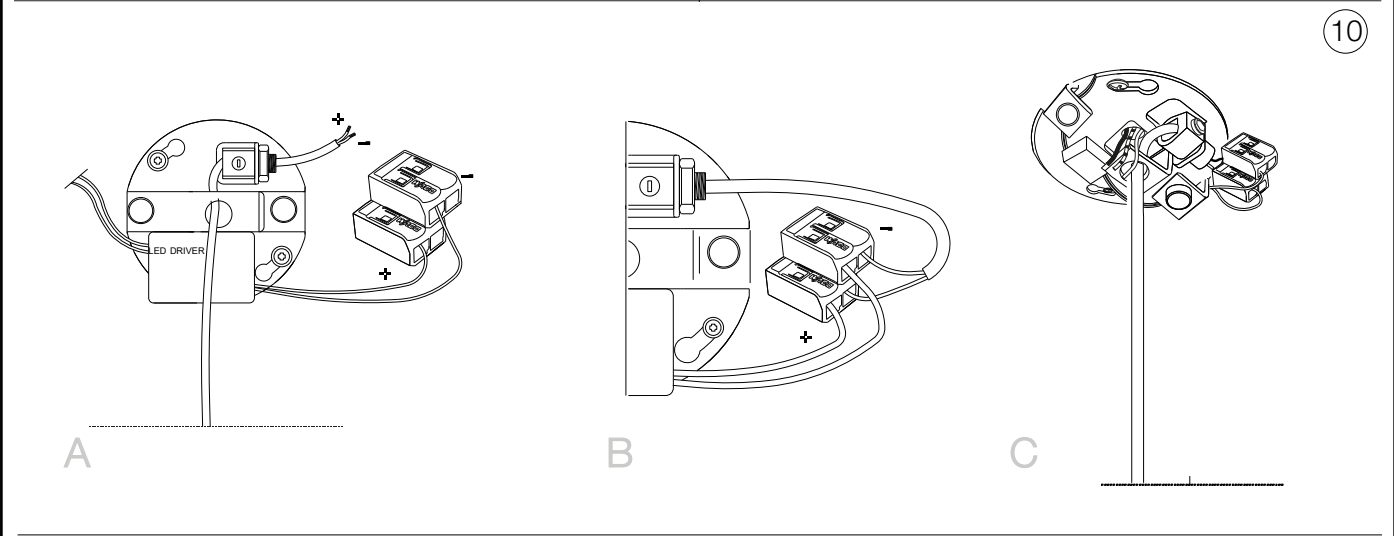
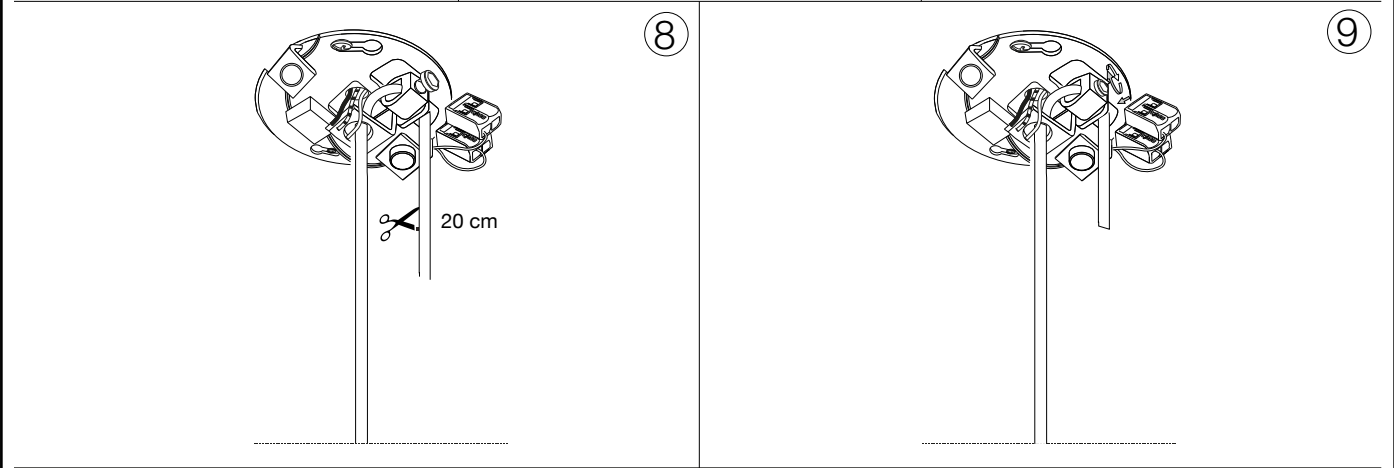
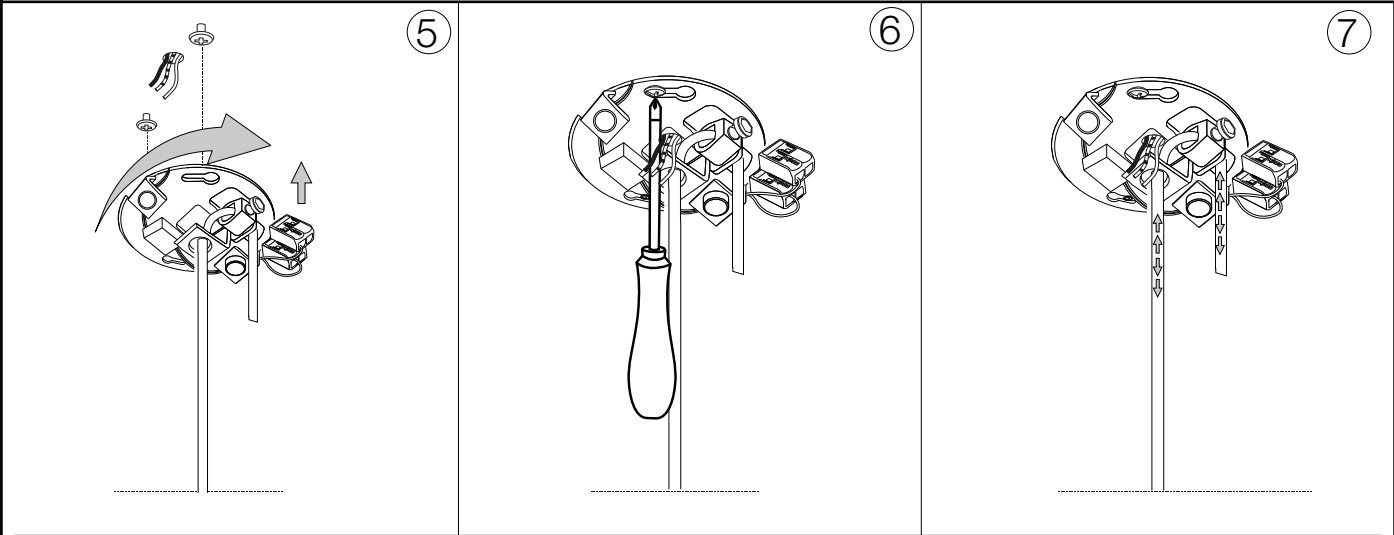

L'installazione deve essere compiuta da personale qualificato.  
The installation must be completed by a qualified electrician.

12

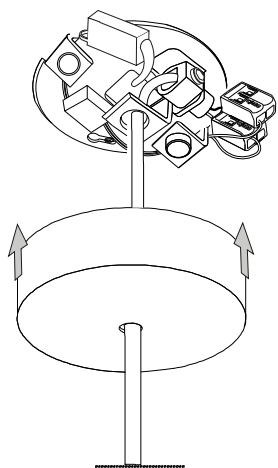

13

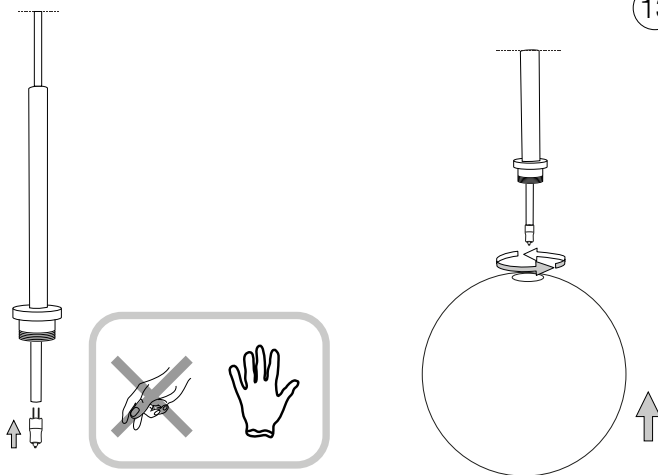

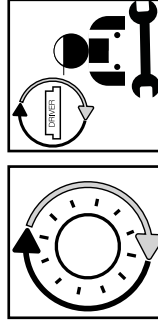

**Questo prodotto contiene una sorgente luminosa  
di classe di efficienza energetica /  
This product is provided with a light source  
with efficiency energy class of:**

**EAN**

**Classe di Efficienza  
Energetica / Energy  
Efficiency Class**

8021696222257

G

**Sorgente Luminosa /  
Light Source (V)**

12 VDC

## LEGENDA ICONE

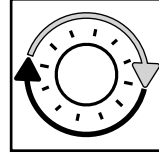

Sorgente luminosa sostituibile  
dall'utente finale.  
Replaceable light source  
by an end-user.

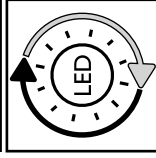

Sorgente LED luminosa sostituibile  
dall'utente finale.  
Replaceable LED light source  
by an end-user.

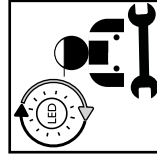

Sorgente luminosa sostituibile  
esclusivamente da personale  
autorizzato.  
Replaceable light source  
by authorized personnel only.

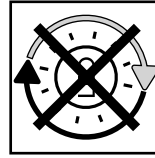

Sorgente luminosa non sostituibile.  
Quando la sorgente arriverà a fine vita  
dovrà essere sostituito l'intero apparecchio.  
Non-replaceable light source.  
Upon end of life of the light source,  
the whole product will be replaced.

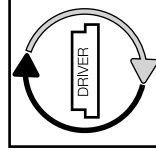

Dispositivo di alimentazione sostituibile  
dall'utente finale.  
Replaceable control gear  
by an end-user.

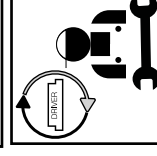

Dispositivo di alimentazione sostituibile  
esclusivamente da personale autorizzato  
Replaceable light source  
by authorized personnel only.

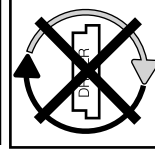

Dispositivo di alimentazione non sostituibile.  
Quando il dispositivo di alimentazione arriverà  
dovrà essere sostituito l'intero apparecchio.  
Upon end of life of the control gear,  
the whole product will be replaced.