

ideal lux®

Equinoxe SP1 D15

1

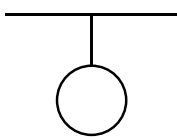

Lampada a sospensione
 Suspension lamp
 Suspension
 Pendelleuchte
 Lámpara colgante
 Люстры и подвесы

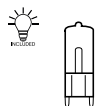

max 1 x 2W G4 LED / 220~240V
 50/60Hz
 - 8021696306537 CROMO
 - 8021696277370 OTTONE

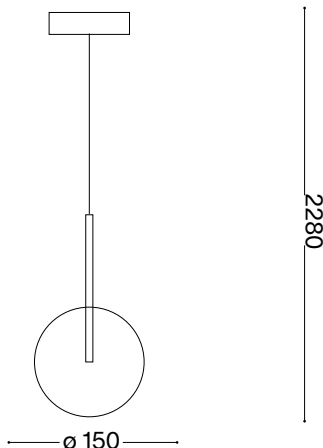

2

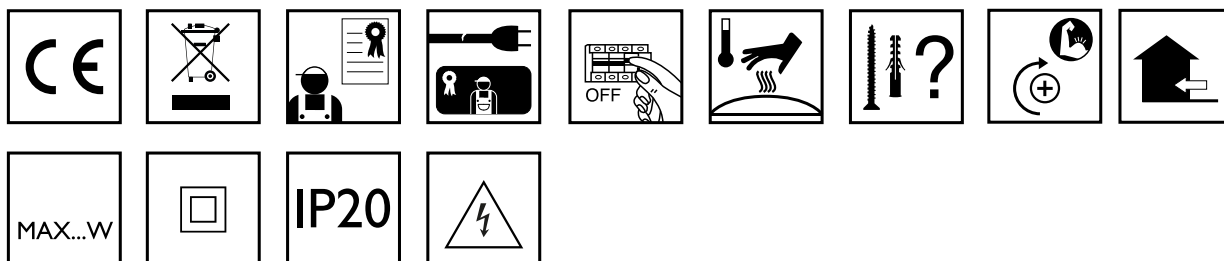

ESEGUIRE LE OPERAZIONI SEGUENDO L'ORDINE PROGRESSIVO. L'INSTALLAZIONE DI QUESTO APPARECCHIO DEVE ESSERE EFFETTUATA DA PERSONALE QUALIFICATO.
 FOLLOW THE ASSEMBLY INSTRUCTIONS BY READING THE NUMERICAL PROGRESSION. THE LIGHTING FITTING SHOULD BE INSTALLED BY A QUALIFIED ELECTRICIAN.

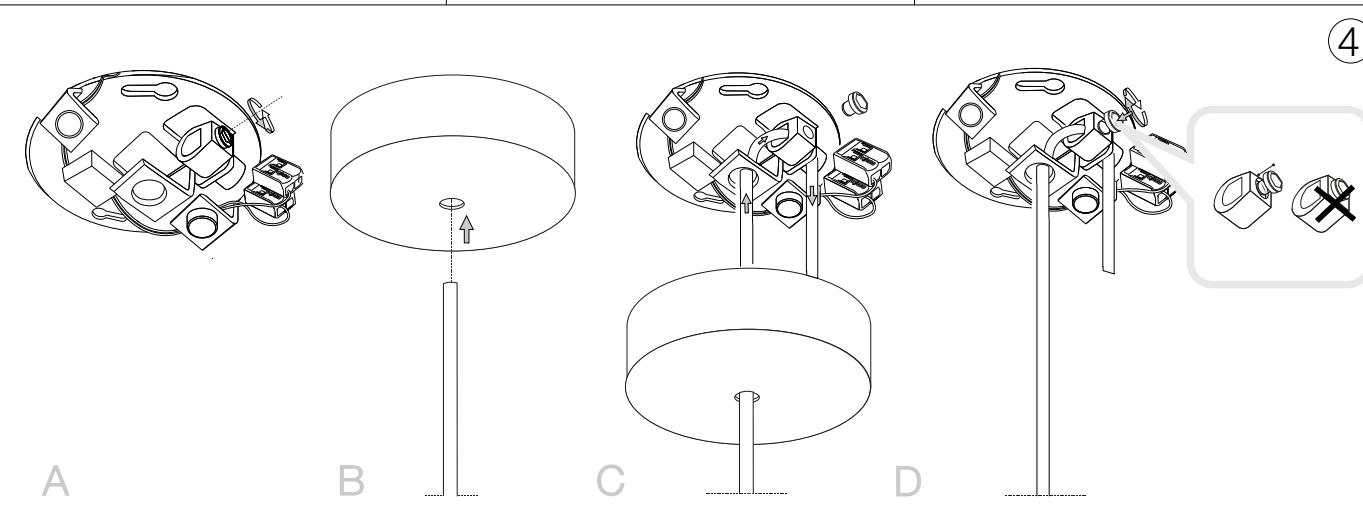
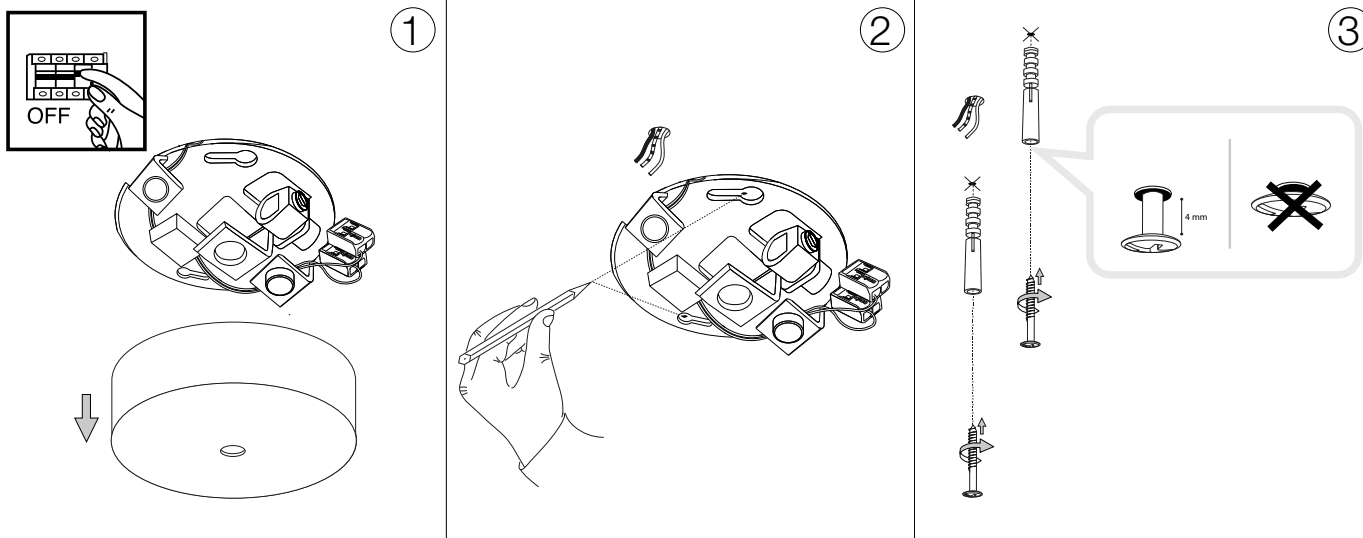

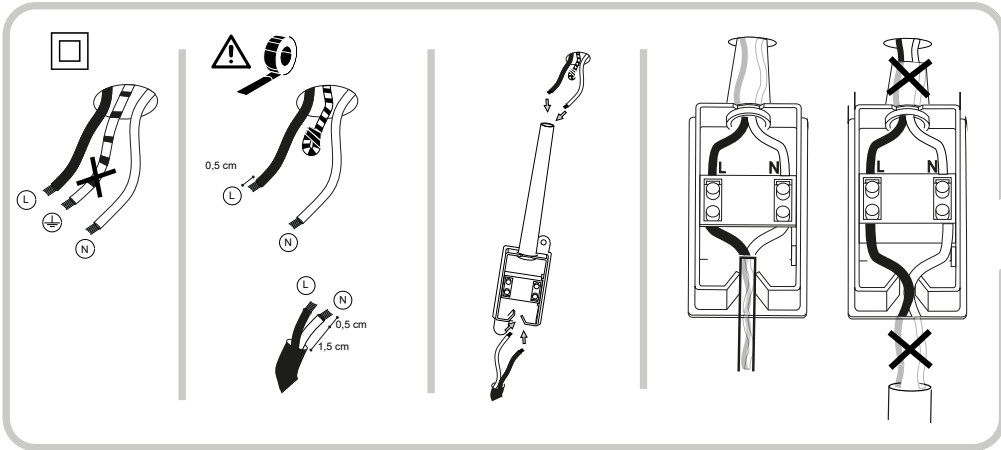
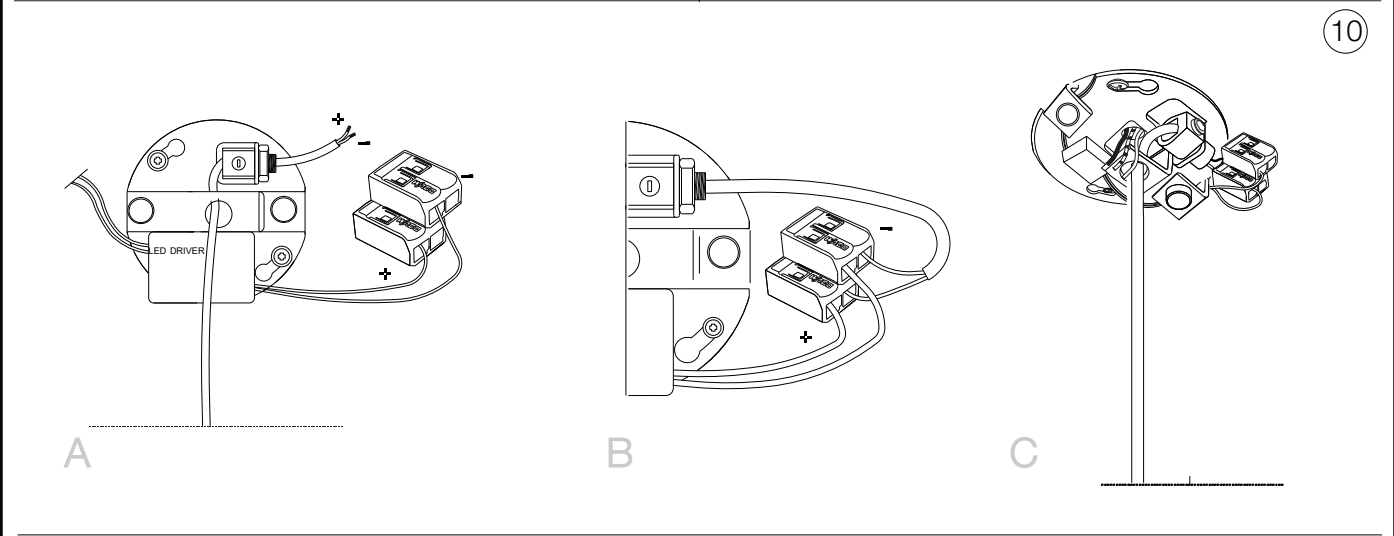
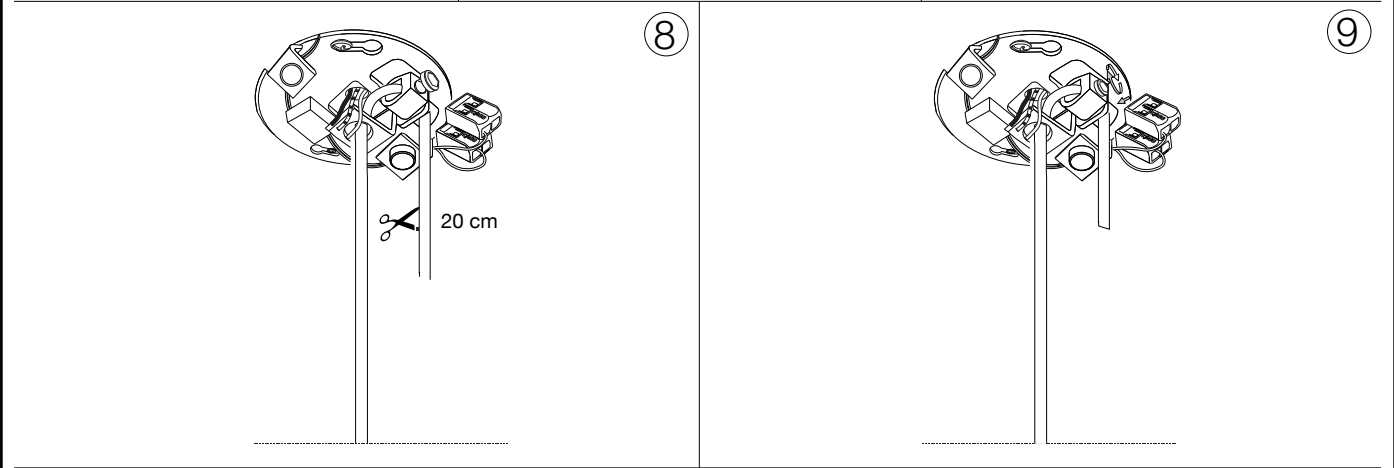
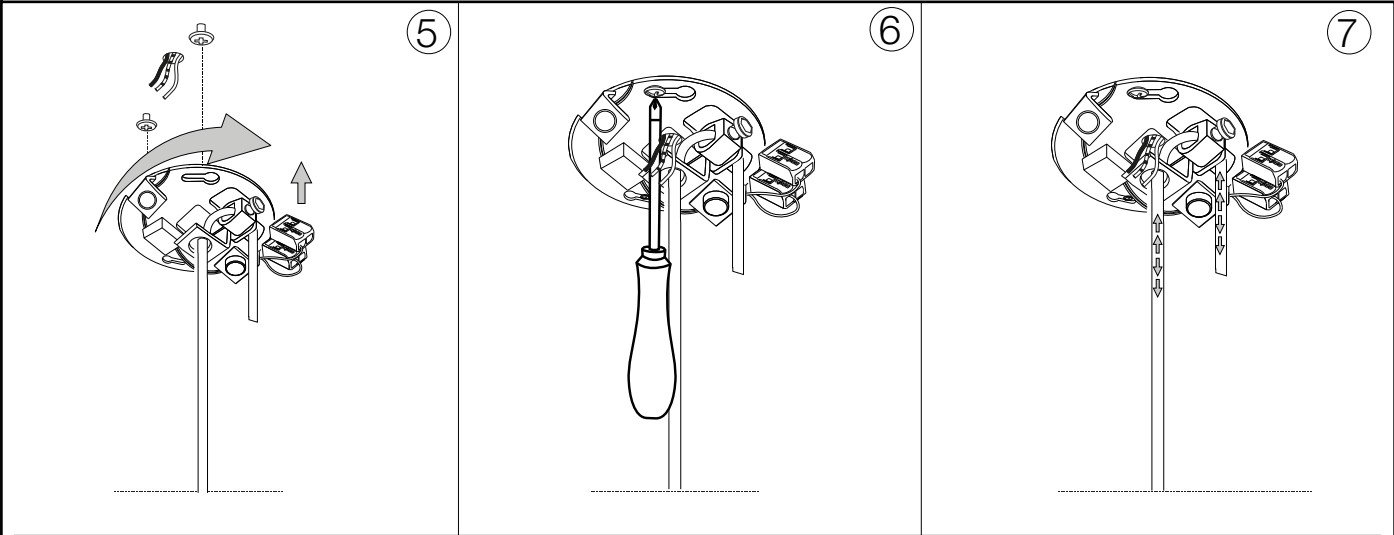

L'installazione deve essere compiuta da personale qualificato.
The installation must be completed by a qualified electrician.

12

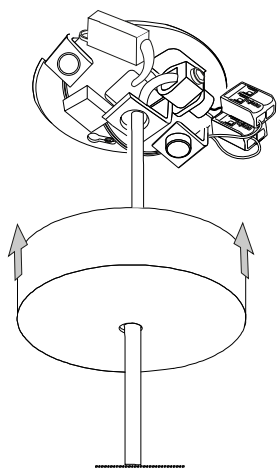

13

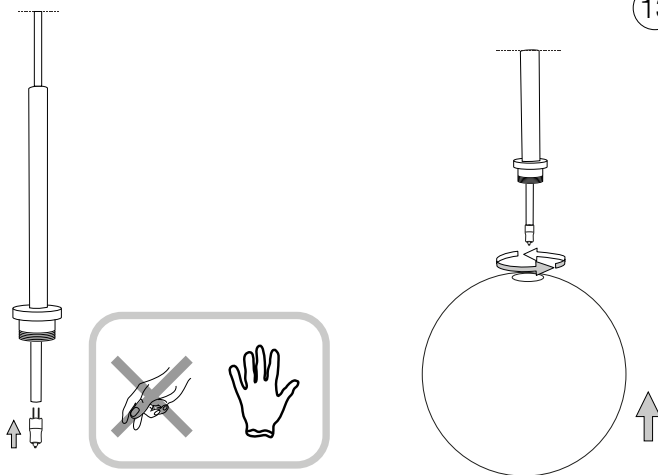

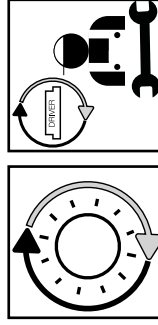

**Questo prodotto contiene una sorgente luminosa
di classe di efficienza energetica /
This product is provided with a light source
with efficiency energy class of:**

EAN

**Classe di Efficienza
Energetica / Energy
Efficiency Class**

8021696222257

G

**Sorgente Luminosa /
Light Source (V)**

12 VDC

LEGENDA ICONE

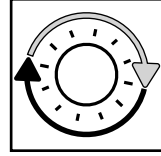

Sorgente luminosa sostituibile
dall'utente finale.
Replaceable light source
by an end-user.

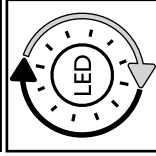

Sorgente LED luminosa sostituibile
dall'utente finale.
Replaceable LED light source
by an end-user.

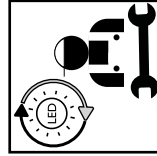

Sorgente luminosa sostituibile
esclusivamente da personale
autorizzato.
Replaceable light source
by authorized personnel only.

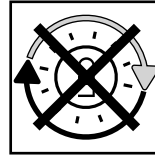

Sorgente luminosa non sostituibile.
Quando la sorgente arriverà a fine vita
dovrà essere sostituito l'intero apparecchio.
Non-replaceable light source.
Upon end of life of the light source,
the whole product will be replaced.

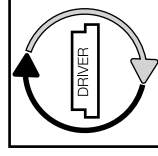

Dispositivo di alimentazione sostituibile
dall'utente finale.
Replaceable control gear
by an end-user.

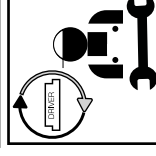

Dispositivo di alimentazione sostituibile
esclusivamente da personale autorizzato
Replaceable light source
by authorized personnel only.

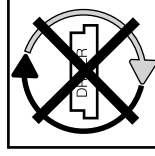

Dispositivo di alimentazione non sostituibile.
Quando il dispositivo di alimentazione arriverà
dovrà essere sostituito l'intero apparecchio.
Upon end of life of the control gear,
the whole product will be replaced.