

ideal lux®

IDEAL LUX s.r.l.
Via Taglio Destro 32
30035 Mirano (VE) Italy
www.ideal-lux.com

IDEAL LUX Warehouse
Via delle Industrie, 8/D
30036 Santa Maria di Sala (Venezia)
8.00 - 12.00 / 13.30 - 17.00



ideal lux®

REV 09/02/2021

Krypton PT

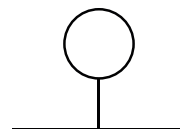

Lampada da terra
Floor lamp
Lampadaire
Stehleuchte
Lámpara de pie
Торшеры

LED

7W LED / 220~240V 50/60Hz
- 8021696269290 ACCIAIO 3000 K
- 8021696121970 ACCIAIO 4000 K

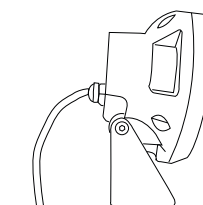
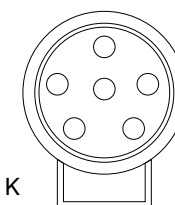

11,5

7

15

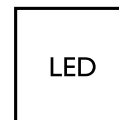
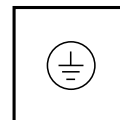
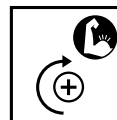
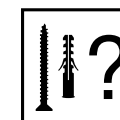
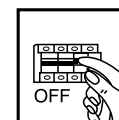
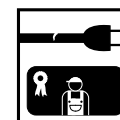
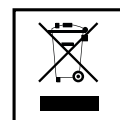
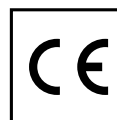

Fonte luminosa non sostituibile.
Not-replaceable light source.

Driver non sostituibile.
Non-replaceable control gear.

IDEAL LUX s.r.l.
Via Taglio Destro 32
30035 Mirano (VE) Italy
www.ideal-lux.com

IDEAL LUX Warehouse
Via delle Industrie, 8/D
30036 Santa Maria di Sala (Venezia)
8.00 - 12.00 / 13.30 - 17.00

ESEGUIRE LE OPERAZIONI SEGUENDO L'ORDINE PROGRESSIVO.
FOLLOW THE ASSEMBLY INSTRUCTIONS BY READING THE NUMERICAL PROGRESSION.

L'INSTALLAZIONE DI QUESTO APPARECCHIO DEVE ESSERE EFFETTUATA DA PERSONALE QUALIFICATO. THE LIGHTING FITTING SHOULD BE INSTALLED BY A QUALIFIED ELECTRICIAN.
Забартажено з мамадєcor.ua

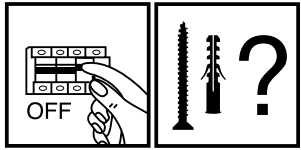

1

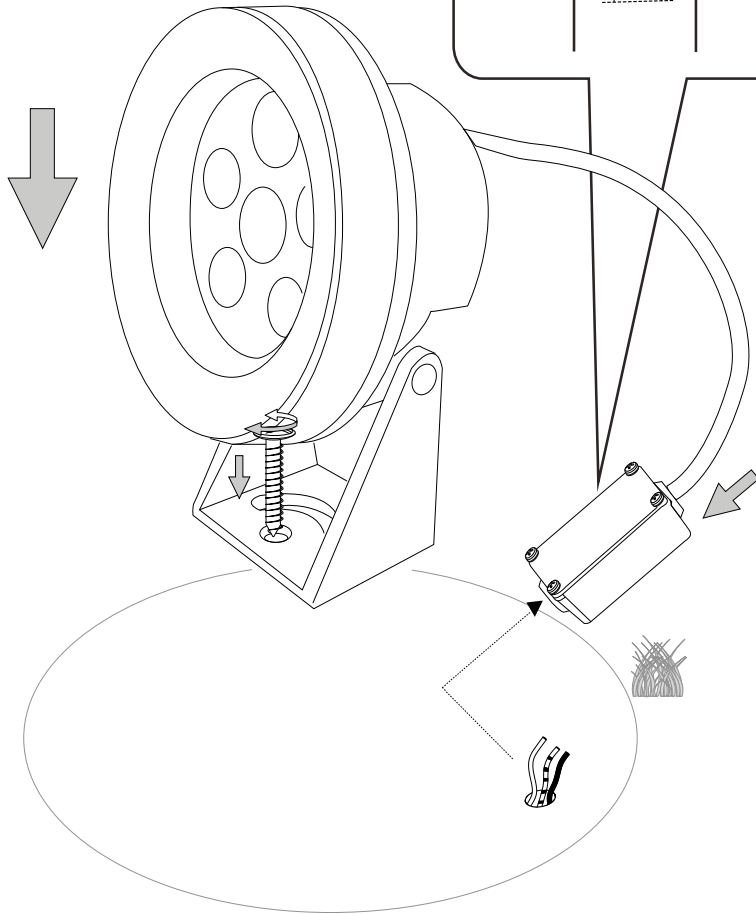
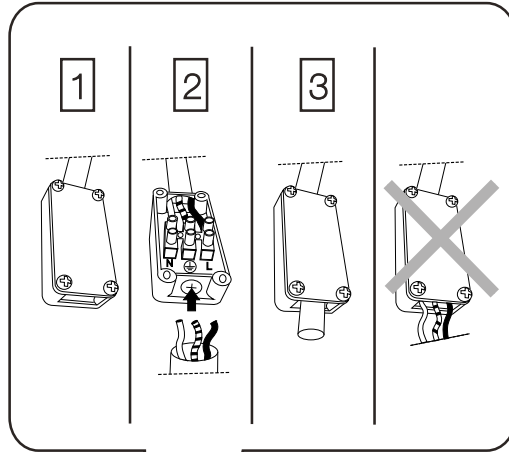

2

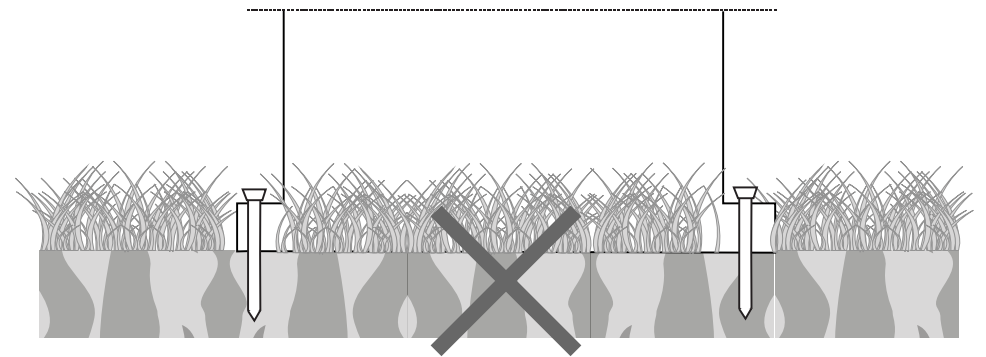
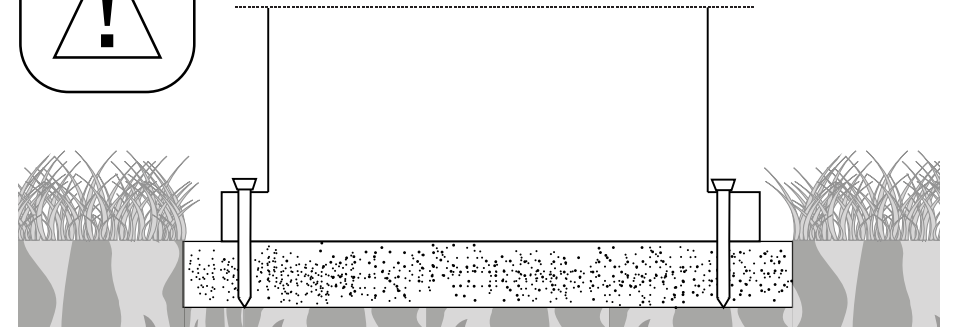

LA SICUREZZA DI QUESTO APPARECCHIO È GARANTITA SOLO CON L'USO APPROPRIATO DI QUESTE ISTRUZIONI, PERTANTO È NECESSARIO CONSERVARLE.
THE SAFETY AND RELIABILITY ARE GUARANTEED ONLY WHEN INSTALLATION INSTRUCTIONS ARE PROPERLY FOLLOWED. PLEASE KEEP THIS INSTRUCTION SHEET FOR FUTURE REFERENCE.

