

# LIKA TRIM

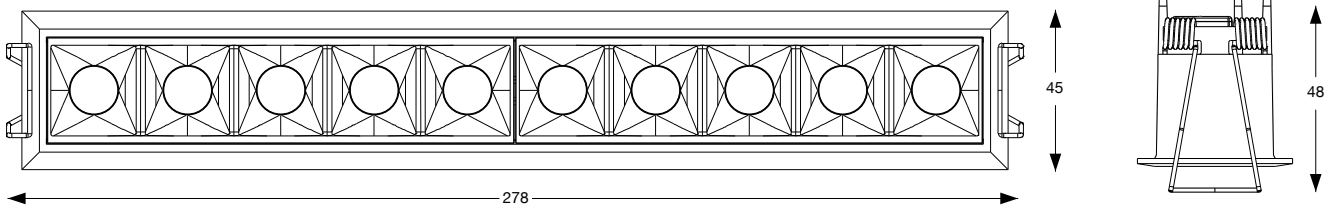

6W  
6W  
12,5W  
12,5W  
21W  
21W

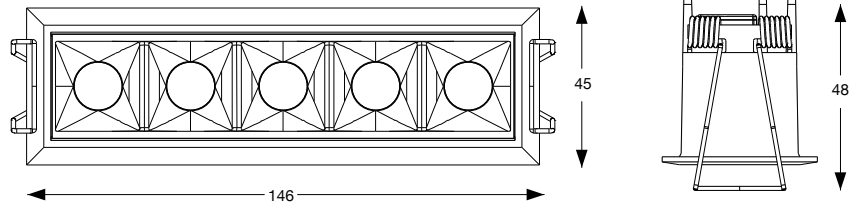
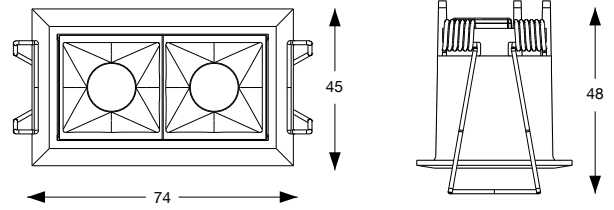

3000 K  
4000 K  
3000 K  
4000 K  
3000 K  
4000 K

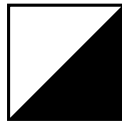

BK  
BK  
BK  
BK  
BK  
BK



206196  
267869  
206219  
267876  
206233  
267883



IP20

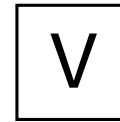
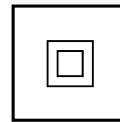

220 - 240 V AC

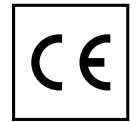

Fonte luminosa non sostituibile. Not-replaceable light source.

Driver non sostituibile. Non-replaceable control gear.

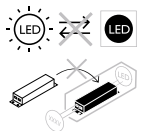

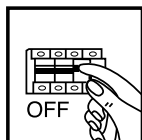

**L'apparecchio di illuminazione dovrebbe essere posizionato in modo che non sia prevista un'osservazione prolungata ad una distanza inferiore a 0,5 m.**  
The prolonged observation should not be planned for a distance less than 0,5 m.  
Place the article with cognition.

1

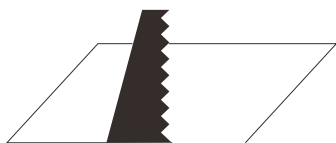

68 x 37 mm

Scegliere la misura ottimale del foro da praticare a seconda dell'articolo scelto.  
Depending on the chosen item drill the hole accordingly.

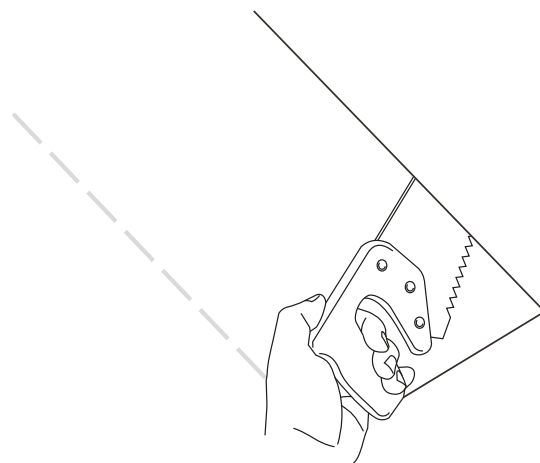

2

Praticare il foro al soffitto.  
Drill the hole into the ceiling.

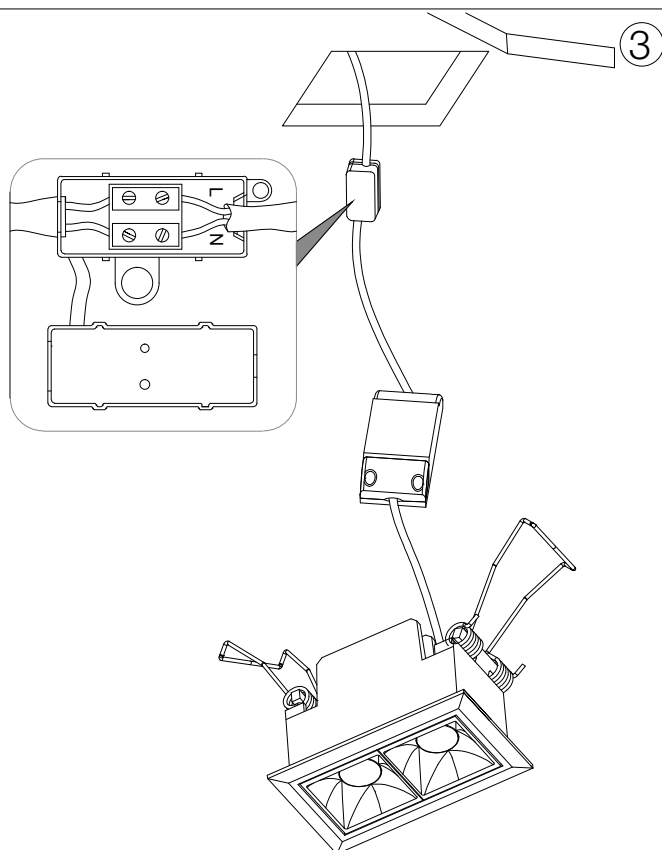

3

Cablare l'articolo usando l'opportuna morsettiere.  
Wire the article using the appropriate terminal box.

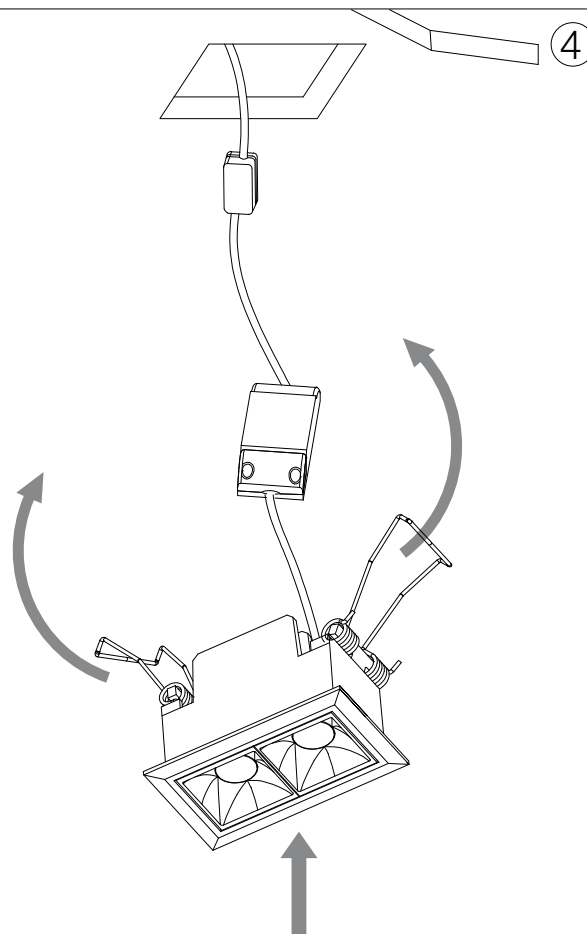

4

Inserire l'articolo nel foro piegando le molle apposite.  
Insert the item into the hole by folding the springs.

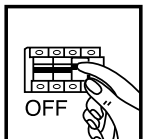

**L'apparecchio di illuminazione dovrebbe essere posizionato in modo che non sia prevista un'osservazione prolungata ad una distanza inferiore a 0,5 m.**  
The prolonged observation should not be planned for a distance less than 0,5 m.  
Place the article with cognition.

1

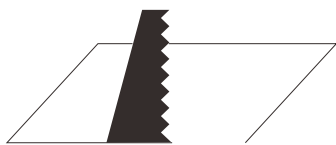

140 x 37 mm

Scegliere la misura ottimale del foro da praticare a seconda dell'articolo scelto.  
Depending on the chosen item drill the hole accordingly.

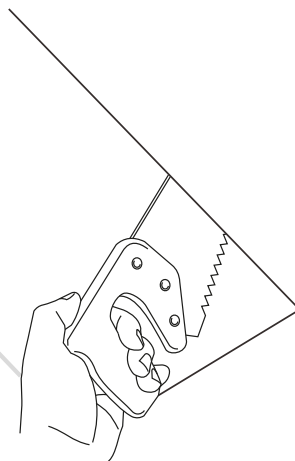

2

Praticare il foro al soffitto.  
Drill the hole into the ceiling.

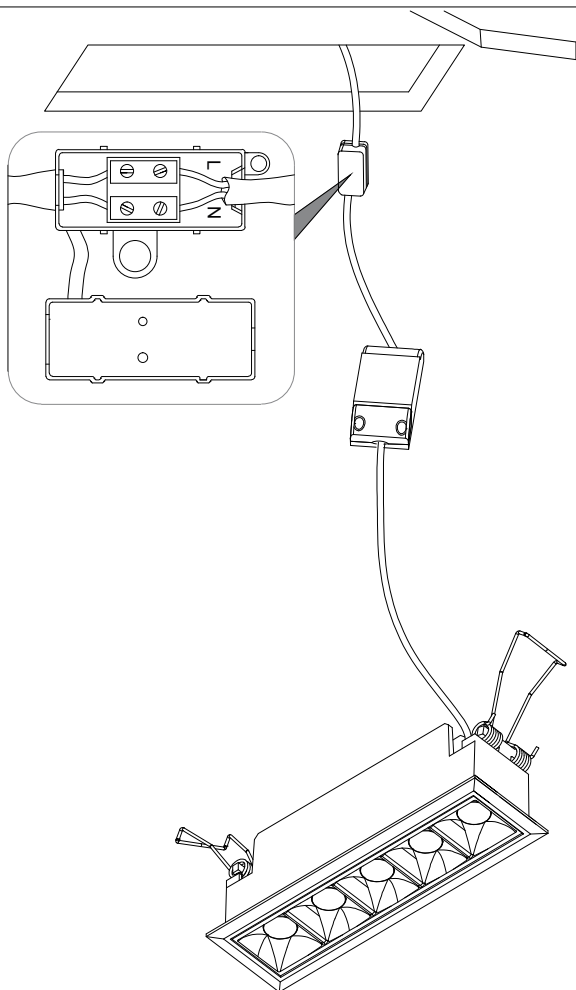

3

Cablare l'articolo usando l'opportuna morsettiere.  
Wire the article using the appropriate terminal box.

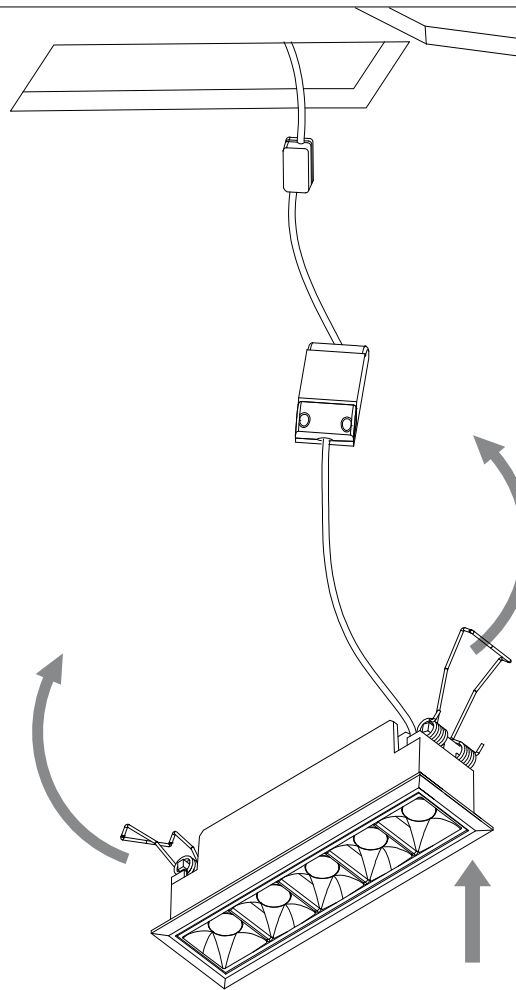

4

Inserire l'articolo nel foro piegando le molle apposite.  
Insert the item into the hole by folding the springs.

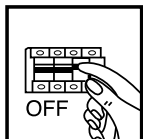

**L'apparecchio di illuminazione dovrebbe essere posizionato in modo che non sia prevista un'osservazione prolungata ad una distanza inferiore a 0,5 m.**  
The prolonged observation should not be planned for a distance less than 0,5 m.  
Place the article with cognition.

1



273 x 37 mm

Scegliere la misura ottimale del foro da praticare a seconda dell'articolo scelto.  
Depending on the chosen item drill the hole accordingly.

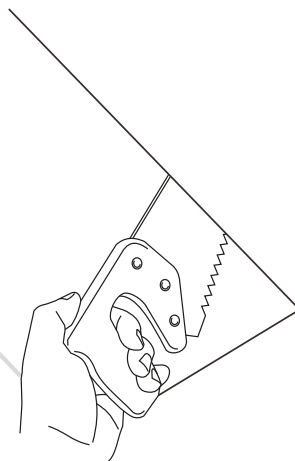

2

Praticare il foro al soffitto.  
Drill the hole into the ceiling.

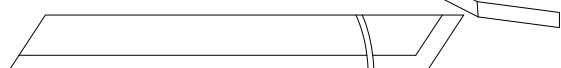

3

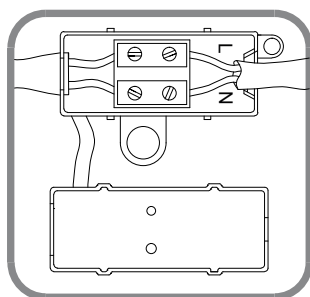

Cablare l'articolo usando l'opportuna morsettiera.  
Wire the article using the appropriate terminal box.

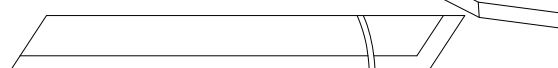

4

Inserire l'articolo nel foro piegando le molle apposite.  
Insert the item into the hole by folding the springs.