

**!**

Min IP65 wiring connection box **NOT INCLUDED**. The installation may need the intervention of a qualified person. The block of connection must comply EN 60998-2-1 or EN 60998-2-2. The block of connection: MAX 10A

Caja de conexión con min IP65 **NO INCLUIDA**. La instalación puede requerir la intervención de una persona cualificada. El bloque de conexión a incluir debe ser conforme con la EN 60998-2-1 o EN 60998-2-2. Bloque de conexión: MAX 10A

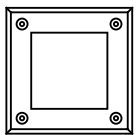
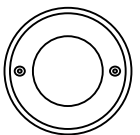
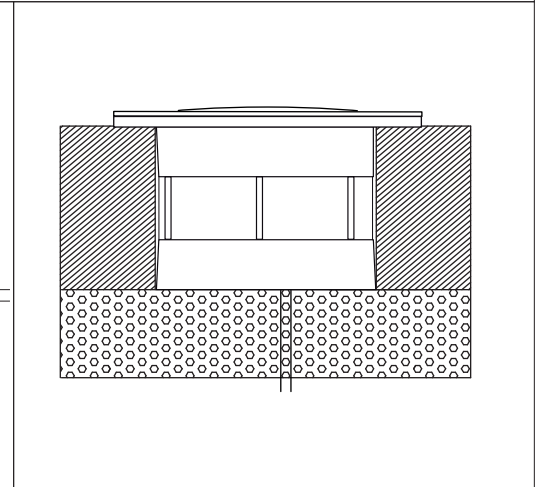
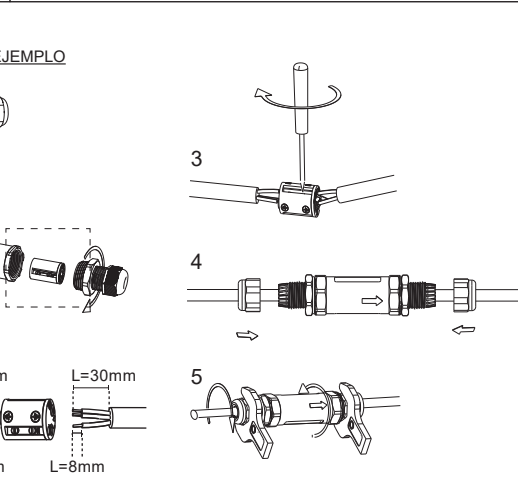

Este producto contiene una fuente luminosa de la clase eficiencia energética G  
This product contains a light source of energy efficiency class G

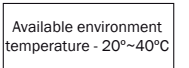
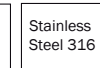
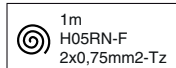

Together we take care of the planet



Together  
we take care  
of the planet

**Together we take care of the planet.**  
This is why we reduce paper consumption. Please refer to the safety, maintenance and warranty instructions at [www.faro.es](http://www.faro.es). If you cannot access it, call us at +34 937 723 965 or write to [export@faro.es](mailto:export@faro.es).

**Juntos cuidamos el planeta.** Por eso reducimos el consumo de papel. Puedes consultar las instrucciones de seguridad, mantenimiento y garantía en [www.faro.es](http://www.faro.es). Si no puedes acceder, llámanos al +34 902 165 166 o escríbenos a [faro@lorefar.com](mailto:faro@lorefar.com).

**Junts cuidem el planeta.** Per això reduïm el consum de paper. Pots consultar les instruccions de seguretat, manteniment i garantia en [www.faro.es](http://www.faro.es). Si no hi pots accedir, telefona'ns al +34 902 165 166 o escriu-nos a [faro@lorefar.com](mailto:faro@lorefar.com).

**Ensemble, nous prenons soin de la planète.** C'est pourquoi nous réduisons la consommation de papier. Veuillez-vous référer aux instructions de sécurité, d'entretien et de garantie sur [www.faro.es](http://www.faro.es). Si vous ne pouvez pas y accéder, appelez-nous au +34 937 723 965 ou écrivez à [export@faro.es](mailto:export@faro.es).

**Insieme proteggiamo il pianeta.** Questo è il motivo per il quale abbiamo ridotto il consumo di carta. Per favore, leggi le istruzioni sulla sicurezza, la manutenzione e la garanzia sul sito [www.faro.es](http://www.faro.es). Se non puoi accedere, chiamaci al +34 937 723 965 o scrivici a [export@faro.es](mailto:export@faro.es).

**Juntos cuidamos do planeta.** É por este motivo que reduzimos o consumo de papel. Consulte as instruções de segurança, manutenção e garantia em [www.faro.es](http://www.faro.es). Se não conseguir aceder, ligue para +34 937 723 965 ou escreva para [export@faro.es](mailto:export@faro.es).

**Gemeinsam sorgen wir uns um unseren Planeten.** Deshalb reduzieren wir den Papierverbrauch. Bitte beachten Sie die Sicherheits-, Wartungs- und Garantiehinweise unter [www.faro.es](http://www.faro.es). Wenn Sie nicht darauf zugreifen können, rufen Sie uns unter +34 937 723 965 an oder schreiben Sie an [export@faro.es](mailto:export@faro.es).

**We dragen samen zorg voor onze planeet.** Daarom verminderen wij het papiergebruik. Raadpleeg de veiligheids-, onderhouds- en garantiehandleiding op [www.faro.es](http://www.faro.es). Kan u ze niet raadplegen? Bel ons op +34 937 723 965 of schrijf ons op [export@faro.es](mailto:export@faro.es).

**Μαζί φροντίζουμε τον πλανήτη.** Για αυτόν τον λόγο μειώνουμε την κατανάλωση χαρτιού. Παρακαλούμε, ανατρέξτε στις οδηγίες ασφαλείας, συντήρησης και εγγύησης στην ιστοσελίδα [www.faro.es](http://www.faro.es). Αν δεν μπορείτε να αποκτήσετε πρόσβαση, τηλεφωνήστε μας στο +34 937 723 965 ή γράψτε μας στο [export@faro.es](mailto:export@faro.es).

**Вместе мы заботимся о планете.** Вот почему мы сокращаем потребление бумаги. Пожалуйста, обратитесь к инструкциям по безопасности, техническому обслуживанию и гарантии на сайте [www.faro.es](http://www.faro.es). Если вы не можете получить к нему доступ, позвоните нам по телефону +34 937 723 965 или напишите на [export@faro.es](mailto:export@faro.es).

**Společně pečujeme o planetu.** Proto omezujeme spotřebu papíru. Přečtěte si, prosím, pokyny týkající se bezpečnosti, údržby a záruky na [www.faro.es](http://www.faro.es). Pokud na stránky nemáte přístup, zavolejte nám na tel. +34 937 723 965 nebo napište na [export@faro.es](mailto:export@faro.es).

**Razem dbamy o planetę.** Dlatego zmniejszamy zużycie papieru. Proszę zapoznać się z instrukcjami bezpieczeństwa, konserwacji i gwarancji na [www.faro.es](http://www.faro.es). Jeśli nie możesz uzyskać do niego dostępu, zadzwoń do nas pod numer +34 937 723 965 lub napisz na adres [export@faro.es](mailto:export@faro.es).

**Заедно ние се грижим за планетата.** Ето защо намаляваме консумацията на хартия. Моля, направете справка с инструкциите за безопасност, поддръжка и гаранция на [www.faro.es](http://www.faro.es). Ако нямате достъп до сайта, обадете ни се на +34 937 723 965 или пишете на [export@faro.es](mailto:export@faro.es).

**Spoločne sme sa postarar' o tejto planéte.** To je dôvod, prečo sme znížili spotrebu papiera. Pozri pokyny k bezpečnosti, údržby a záruky na [www.faro.es](http://www.faro.es). Ak nemôžete prístupovať, zavolajte na telefónne číslo +34 937 723 965 alebo píšete n [export@faro.es](mailto:export@faro.es).

**معا نعتني بالكوكب.**  
هذا هو السبب في تقليل استهلاك الورق.  
يرجى الرجوع إلى تعليمات السلامة والصيانة والضمان على [www.faro.es](http://www.faro.es)  
إذا لم تتمكن من الولوج إليه، اتصل بنا على +34 937 723 965 أو اكتب رسالة إلى [export@faro.es](mailto:export@faro.es)