

AQUA

astro

GB

PLEASE READ THE INSTRUCTIONS CAREFULLY  
BEFORE COMMENCING ASSEMBLY

Live: Normally Brown / Red  
Neutral: Normally Blue / Black  
Earth: Normally Green / Yellow

IT

LEGGERE ATTENTAMENTE LE ISTRUZIONI  
PRIMA DI COMINCIARE L'ASSEMBLAGGIO

Cavo positivo: normalmente marrone o rosso  
Cavo neutro: normalmente blu o nero  
Cavo terra: normalmente verde o giallo

FR

LIRE ATTENTIVEMENT LES INSTRUCTIONS  
AVANT DE COMMENCER LE MONTAGE

Phase: Normalement Brun / Rouge  
Neutre: Normalement Bleu / Noir  
Terre: Normalement Vert / Jaune

DE

LESEN SIE BITTE DIE ANWEISUNGEN  
SORGFÄLTIG DURCH, BEVOR SIE MIT DEM  
ZUSAMMENBAUEN BEGINNEN

Phase: Normalerweise Braun / Rot  
Nulleiter: Normalerweise Blau / Schwarz  
Erde: Normalerweise Grün / Gelb

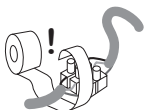
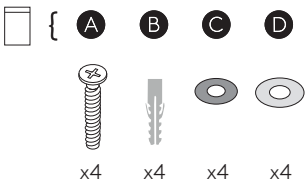
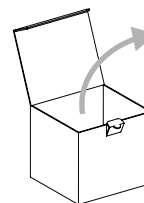
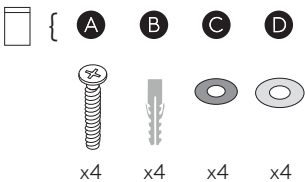
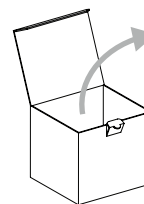
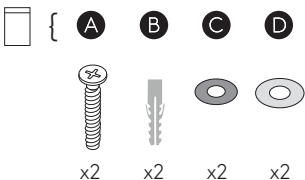
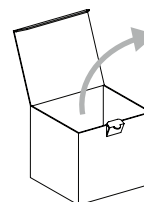
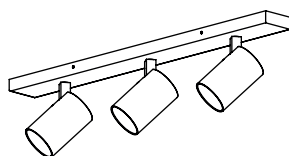
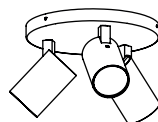
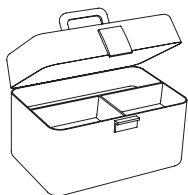
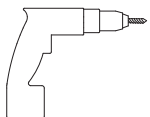
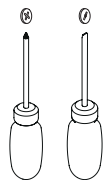
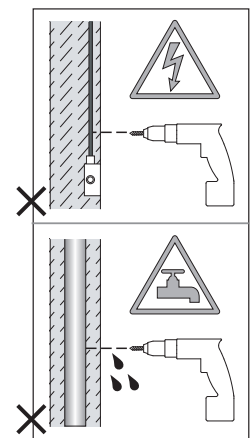

ALL ELECTRICAL CONNECTIONS MUST BE FULLY COVERED WITH INSULATING TAPE.  
Toutes les connexions électriques doivent être entièrement recouvertes de ruban isolant.  
Alle elektrischen Anschlüsse müssen vollständig mit Isolierband abgedeckt werden.  
Tutte le connessioni elettriche devono essere coperte perfettamente con il nastro isolante.

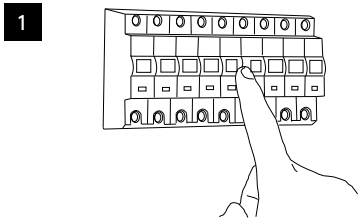

**1**

**TURN OFF POWER**  
 Couper Le Courant! / Strom Abhalten!  
 / Corte La Corriente!

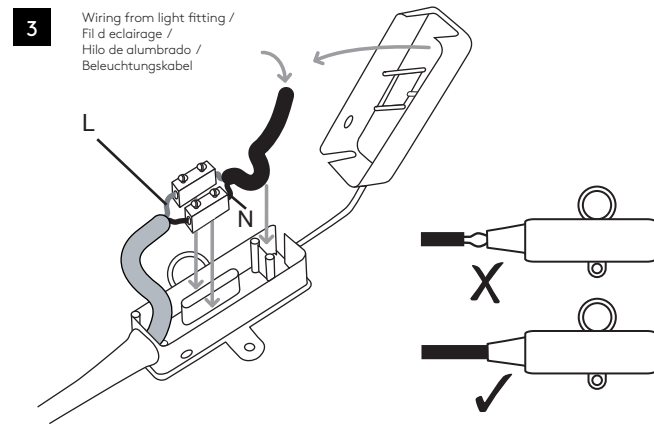
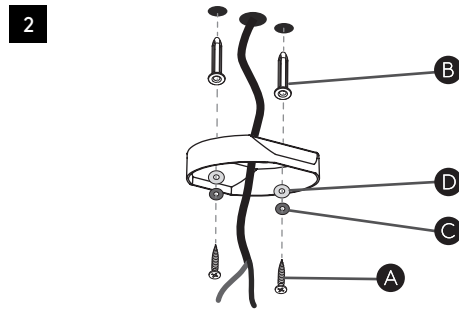

**3** Wiring from light fitting /  
 Fil d'eclairage /  
 Hilo de alumbrado /  
 Beleuchtungskabel

