

CROMARTY 100

7882 / SKU 1378001

8188 / SKU 1378002

astro

CROMARTY 120

8189 / SKU 1378003

GB

Products with electronic ballasts / drivers must not be installed on the same electrical circuits as products with inductive loads, for example magnetic fluorescent luminaires, motors or ventilators. Inductive loads can generate excessive voltage surges which can damage electronic ballasts.

PLEASE READ THE INSTRUCTIONS CAREFULLY BEFORE COMMENCING ASSEMBLY

Live: Normally Brown / Red

Neutral: Normally Blue / Black

Earth: Normally Green / Yellow

FR

Les luminaires utilisant un ballast électronique / drivers ne peuvent être installés sur le même circuit que des appareils avec charges inductives, tels que luminaires fluorescents magnétiques, moteurs et ventilateurs. Les charges inductives peuvent générer des voltages excessifs et ainsi endommager les ballasts électroniques.

LIRE ATTENTIVEMENT LES INSTRUCTIONS AVANT DE COMMENCER LE MONTAGE

Phase: Normalement Brun / Rouge

Neutre: Normalement Bleu / Noir

Terre: Normalement Vert / Jaune

IT

Tutti i prodotti che includono ballast elettronici non devono essere installati sugli stessi circuiti elettrici come anche prodotti con carichi induttivi quali lampadari a fluorescenza magnetica, motori o ventilatori. I carichi induttivi possono generare scariche eccessive che possono danneggiare i ballast.

LEGGERE ATTENTAMENTE LE ISTRUZIONI PRIMA DI COMINCIARE L'ASSEMBLAGGIO

Cavo positivo: normalmente marrone o rosso

Cavo neutro: normalmente blu o nero

Cavo terra: normalmente verde o giallo

DE

Produkte mit elektronischen Vorschaltgeräten/ Treibern dürfen nicht im selben Stromkreislauf installiert werden wie Verbraucher mit induktiven Lasten, z.B. magnetische Leuchtstofflampen, Motoren oder Ventilatoren. Induktive Lasten können übermäßige Spannungsspitzen erzeugen, die elektronische Vorschaltgeräte beschädigen könnten.

LESEN SIE BITTE DIE ANWEISUNGEN SORGFALTIG DURCH, BEVOR SIE MIT DEM ZUSAMMENBAUEN BEGINNEN

Phase: Normalerweise Braun / Rot

Nullleiter: Normalerweise Blau / Schwarz

Erde: Normalerweise Grün / Gelb



UNSUITABLE FOR DIMMING

Ne convient pour gradateur

Non dimmerabile

Nicht zum Dimmen geeignet

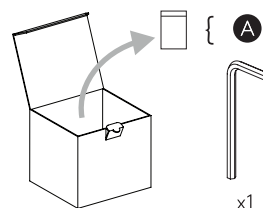
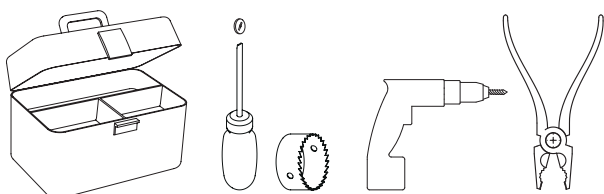

1

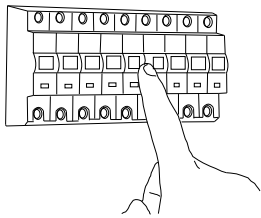

TURN OFF POWER
Couper Le Courant! / Strom Abshalten!
/ Corte La Corriente!

2a

INSTALLATION IN GROUND/LOOSE SURFACE. NOT REQUIRED FOR DECKING

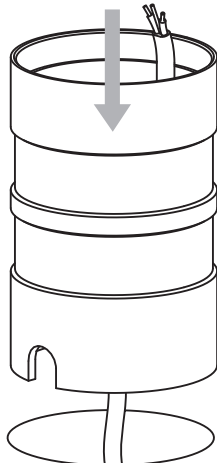

7882/8188 = \varnothing 94mm
8189 = \varnothing 107mm

2b

INSTALLATION IN DECKING

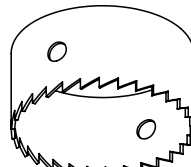

7882/8188 = \varnothing 92mm
8189 = \varnothing 106mm



3

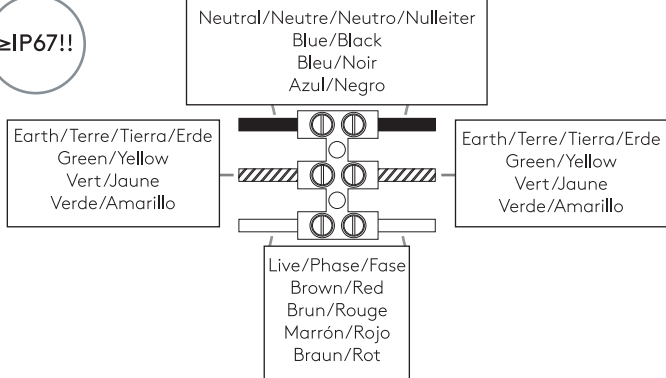
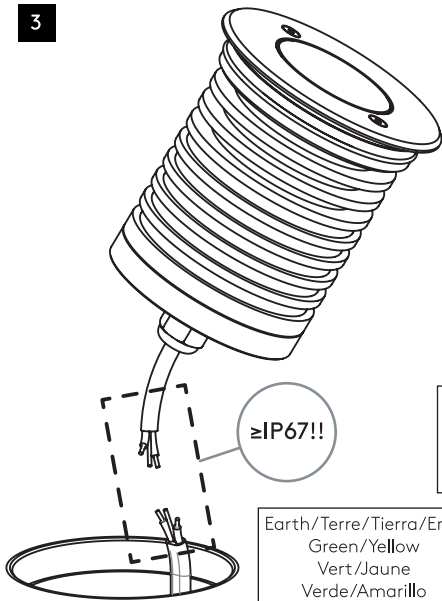

4

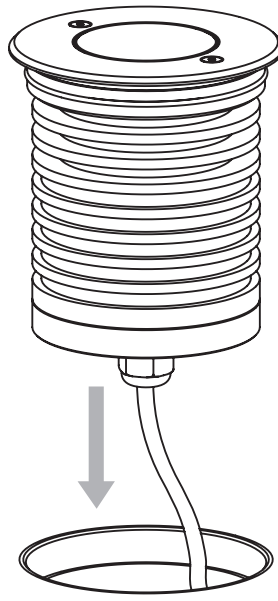

5

