

TARO ROUND ADJUSTABLE astro

GB

PLEASE READ THE INSTRUCTIONS CAREFULLY
BEFORE COMMENCING ASSEMBLY

Live: Normally Brown / Red
Neutral: Normally Blue / Black
Earth: Normally Green / Yellow

FR

LIRE ATTENTIVEMENT LES INSTRUCTIONS
AVANT DE COMMENCER LE MONTAGE

Phase: Normalement Brun / Rouge
Neutre: Normalement Bleu / Noir
Terre: Normalement Vert / Jaune

IT

LEGGERE ATTENTAMENTE LE ISTRUZIONI
PRIMA DI COMINCIARE L'ASSEMBLAGGIO

Cavo positivo: normalmente marrone o rosso
Cavo neutro: normalmente blu o nero
Cavo terra: normalmente verde o giallo

DE

LESEN SIE BITTE DIE ANWEISUNGEN
SORGFALTIG DURCH, BEVOR SIE MIT DEM
ZUSAMMENBAUEN BEGINNEN

Phase: Normalerweise Braun / Rot
Nulleiter: Normalerweise Blau / Schwarz
Erde: Normalerweise Grün / Gelb

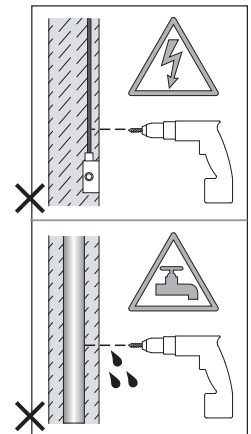

NOT SUITABLE FOR COVERING WITH THERMAL INSULATION.
Ne peut être recouvert de matériaux d'isolation.
Non adatto ad essere coperto da isolanti termici.
Nicht für die Abdeckung mit Wärmedämmung geeignet.



FOR CEILING USE ONLY
Seulement pour montage au plafond
Da utilizzarsi solo al soffitto
Nur für den Deckengebrauch



NOT SUITABLE FOR MOUNTING IN FLAMMABLE
MATERIALS, E.G. WOOD.
Ne convient pas pour montage dans des matériaux inflammables.
Non adatto ad essere montato in materiali infiammabili (per esempio legno).
Nicht geeignet für eine Installation auf brennbaren Materialien, wie z.B. Holz.

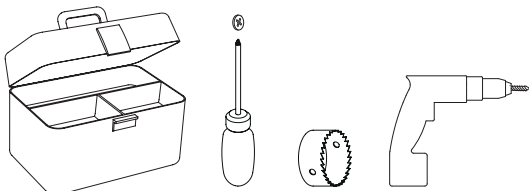

1



TURN OFF POWER

Couper Le Courant! / Spegnere La Corrente! /
Strom Abhalten!

2

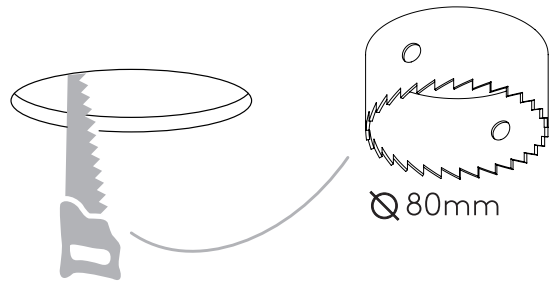

3

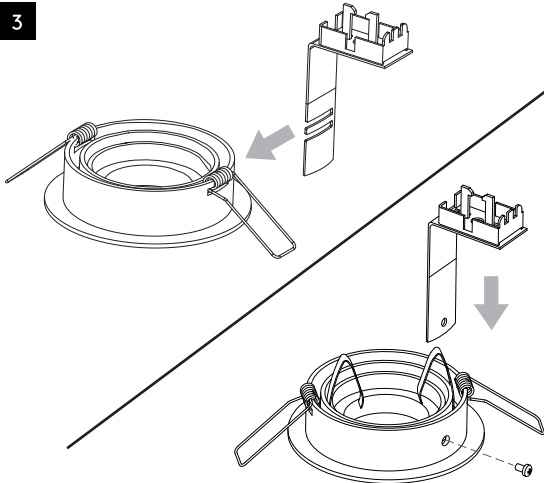

4

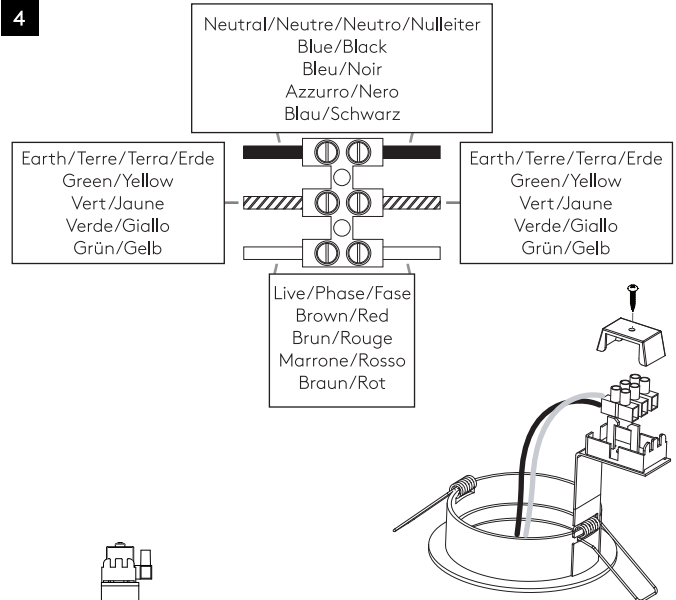

5

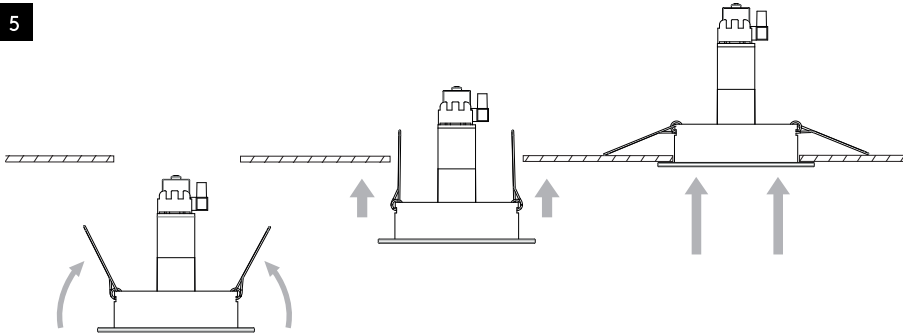

6

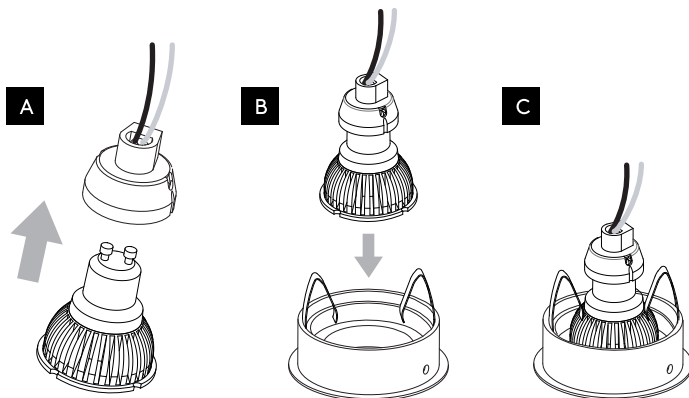

7

