



# Zenit

Natural in its habitat



- Premium modular light switch range
- Multi-standard: fitting in European, American and Italian boxes
- Eco-designed
- More than 100 functions in four finishes

# Contents

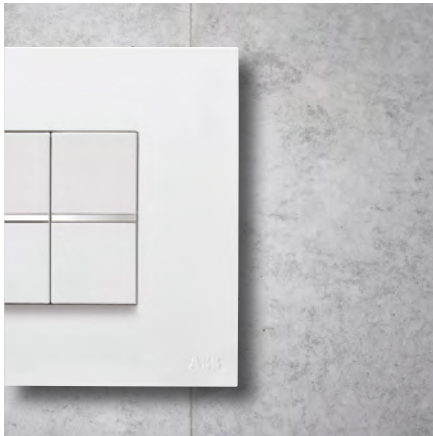

## Zenit

The top in design and performance	06
The top in residential	08
The top in hospitality	12
The top in the office	16
The top in shopping	20
Functions for all spaces	24
All weather and surface solutions	84

## Tertiary solutions

Systems for centralized controls	90
Better aesthetics outside and greater comfort inside	92
Systems for workstations	96
The maximum simplicity and comfort in the installation	98

## Sound system

Music from any device	108
Multiroom	109
Ease in your projects	110
Also in the renovation	111

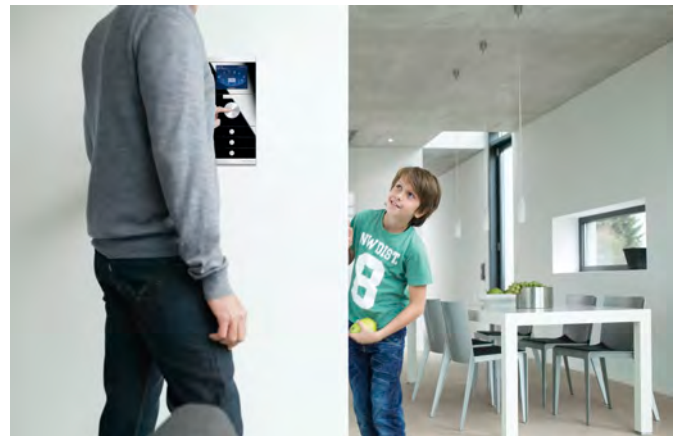

## ABB-free@home®

Home becomes smart	118
Just as you like it	120
Free choice	122
Total networking	124
Atmosphere at the press of a button	134
Home appliance	130
Present and yet not at home	136
Everything off with a single function	138
Easy to use	140

## ABB i-bus® KNX

Rooms with intelligence	150
KNX. Suitable for every need	152
The perfect connection	154

---

# Zenit

## The highlight of modular series

Zenit is the most comprehensive modular range for all kind of homes and commercial buildings. A number of appreciated designs and beautiful finishes that add value to the facility, with advanced features that provide greater comfort and performance level. With Zenit you can make any type of installation, can enjoy benefit of technical advantages that make it easier and faster. This range has the guarantee of a brand renowned for its quality such as ABB.

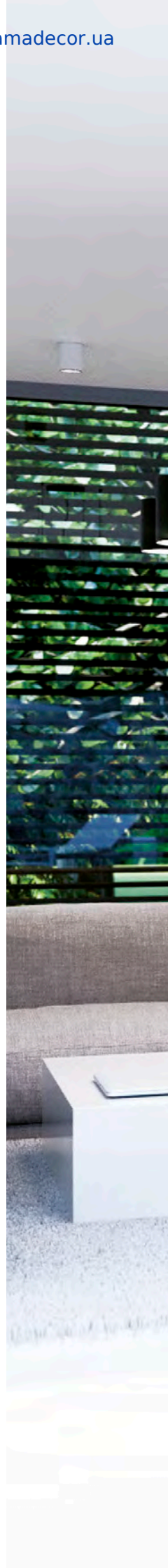



---

# The top in design and performance

## For its aesthetics and details

### Simple, elegant, the top in design.

Zenit is born with a high-rise design. With rectilinear lines, very trendy finishes and full of details that enhance its aesthetics. It reaches the highest levels in quality and infinite values.



**Zenit Float**  
7,5 mm height.  
Visually lightened  
through the 2 piece  
floating effect.

**Zenit Solid**  
7,5 mm height.  
Compact and firm  
profile. Solid effect  
with own  
personality.

**Zenit Soul**  
4,1 mm height.  
The essential frame  
with a ultra-light  
profile, being one of  
the slimmest frames  
in the market.

## Wide range



### Display and styling trim

Lighting in green and white. Styling trim in Chrome, Anthracite, White and Champagne



### Multi-standard

Fitting in European, American and Italian boxes

### High-quality and durable finishes.

Noble materials in frames

### Eco-design

Designed following the Eco-Design ISO 14006 regulations.

Made in Spain with 100% renewable energy.



More than 100 functions in four finishes



Symbols with backlight



---

## The top in residential

To bring the comfort to all the family

---

Never before has your home been so comfortable, safe, efficient and beautiful. Today's modern living spaces demand comfort in every room, whether it's the bathroom transforming into a wellness spa or kitchens becoming communication islands. Zenit offers solutions for future-oriented lifestyle in residential living environments.

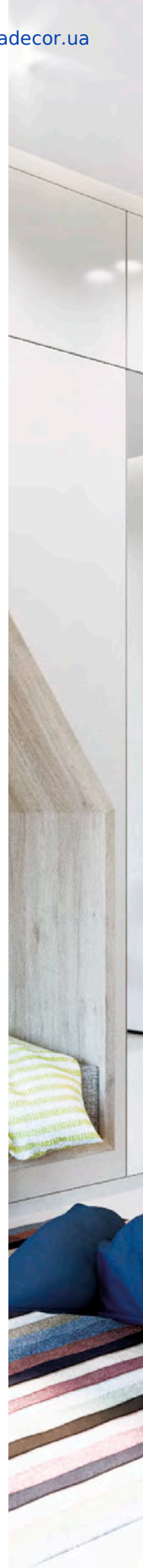





---

## Zenit & ABB-free@home®

Making home automation easier than ever. Simply smart. Zenit and ABB-free@home® transform the house or the apartment into an intelligent home. Whether it's blinds, lights, heating, air conditioning, door communication or scenes. Easy to remote control via a switch on the wall, with the laptop or with the smartphone. Very convenient. Extremely comfortable. Very energy efficient. Especially attractive. Only minimal costs are involved when compared with conventional electrical installations.





### Sound system

Music stirs the emotions. At any location. A flexible and convenient audio system for entertainment and communication. Its high-quality components impress with the utmost in functionality, intuitive operation and innovative design. In combination with the practical accessories it is a unique range of high-performance products that offers individual solutions for every application.



### Management of blinds

The blind management range opens new dimensions for the private housing construction sector. You can now enjoy greater living comfort, safety and economic efficiency in your house. The blind management system is suitable for controlling all motor-driven blinds, roller blinds and awnings. Its many options for application, connection and setting make it the ideal solution for every housing situation.



### LED dimmers

Always the perfect light. Beautiful music, a glass of wine, a soft sofa. What makes this even more perfect now is pleasantly subdued and colourful illumination. The innovative and elegant dimmer units with their soft reduction of the volume of light create an intimate, cosy atmosphere. They offer the possibility of creating the kind of illumination that suits the mood and the occasion. And they add a special kind of magic to those intimate moments.

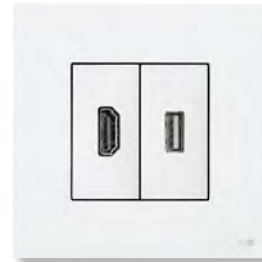

### Multimedia connectivity

Communication is the gateway to the world. Enjoyable entertainment! The new VDI connectors are suitable for multimedia devices in your home. All conventional connectors are supported: double and triple RCA, Mini-Jack, VGA, HDMI and USB.



### All weather IP55

Do not worry about the weather. IP55 boxes and frames for flush and surface mounting that allows installing any device in outdoor environments.

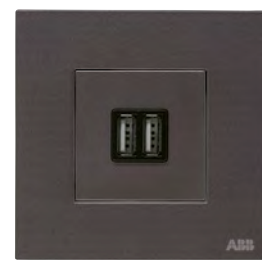

### USB charging devices

The end of overfilled multiple socket outlets has arrived. The USB charging devices are the ideal location for charging mobile telephones, tablets or smart watches.

---

## **The top in hospitality**

To make guests feel at home

---

All factors are working together for design and comfort. Take comfort to new heights. Hotel guests are demanding. The design is just one aspect. What's particularly important is the light, blinds, air conditioning and heating work together to create an atmosphere where your guests enjoy every second of their stay and look forward to returning.

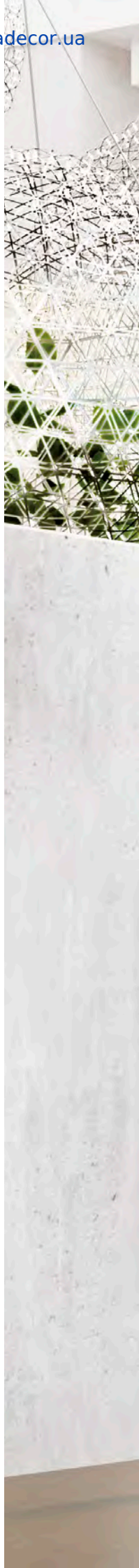



---

## Zenit & ABB i-bus® KNX

Perfect climate. A perfect hotel room is never too warm, never too cool and always filled with fresh air – it stimulates all of your senses. The invisible technology, ABB i-bus® KNX, makes this possible. Everyone can get to grips with it straight away thanks to the room temperature controller with its clear design. As a result, you can control the heating, ventilation and air conditioning with the touch of a finger and a glance at the display – it's as simple and clear as that.

### **Measurable efficiency, all costs under control**

Comfortable cost reductions. You don't always have the same number of people staying in a hotel room. This is why it is important to adjust the resources to the use in order to increase efficiency. Intelligent presence detectors with a direct KNX connection adjust the indoor climate and light sensitively. With their extensive coverage and discreet design, they blend seamlessly into the architecture – almost invisible but highly effective.

### **Maximum safety for guests and investments**

More than a feeling. Intelligent technology is behind all that is safe. Only a fully networked building creates an environment which protects the people and values. The ABB i-bus® KNX brings everything together. By integrating all applications, the result is stability for everyone.





### Multimedia center

Hotel guests can enjoy their own taste in music. The sound comes directly from the wall, without a tangle of cables. It is possible to connect a smartphone via both Bluetooth and at the same time charge it or connect the laptop to the TV via the HDMI connector. Therefore all the technology can fit in a saving space module housing in line with the interior design – ideal for the space next to the bed or in the desk. Sound contributes to comfort.



### Card switch

A friendly welcome. Perfection begins at the room door with the card switch. If you insert the card here, a light scene switches on automatically. The temperature is regulated immediately. The room itself says “welcome”!

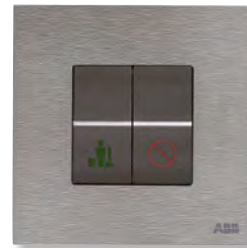

### Do not disturb / Make-up room

Always tidied up, rest without interruption. The integrated DND/MUR switch and LED signaling light indicates to the service personnel whether the guest wishes to not be disturbed or for their room to be made up.



### Signaling and beacon lights

Clear orientation. Guests appreciate the superior welcome they experience through clear signals. The signaling labels help them to get their bearings. These pictograms provide information during the day and night, and which show the way. With LED technology and high-quality diffuser really emphasize the contemporary features.



### Movement detector

Constant vigilance. Safety begins with visibility. The movement detectors react sensitively and immediately. They ensure that no one has to stumble around in the dark. With a detection range of up to 110°, we have a suitable movement detector integrated with the interior design for corridors, rooms or common areas.

---

## **The top in the office**

To make the working time easier

---

The perfect working environment helps a business grow and develop. Zenit can provide the best in office space planning, from light and temperature control, workstations, ABB i-bus® KNX and ABB-free@home® automation to everything in between. From medium sized businesses to large corporations, we can provide designs in any modern finish or material to suit the needs of any interior decoration.

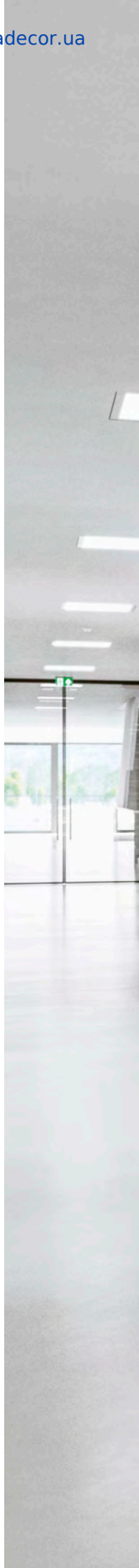





---

## Workstations

Power, voice, image and data in one connection point.

In an office the number of workplaces that require being connected to computers and multimedia equipment is increasing. This system makes it possible to group all together the needs of a working place (electrical outlets, telephone, data, protection and multimedia) in a single box. The Zenit workstations have been meticulously designed with innovative breakthroughs, devised to solve any installation in the most comfortable, quick and easy way.

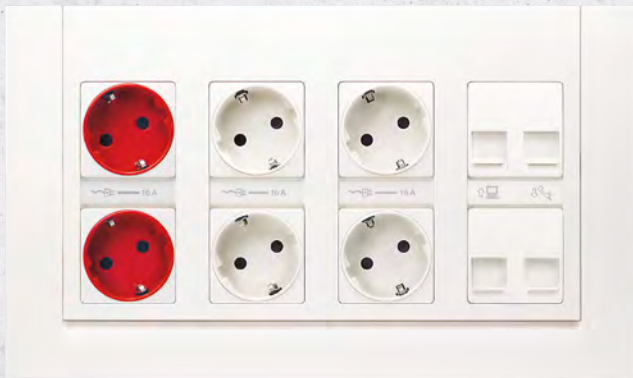



### Multimedia and data connectivity

Voice, data and image are part of the nowadays working environments. Zenit offers a wide number of devices that can solve any need in terms of connectivity: 2x RCA, 3x RCA, Mini-Jack, VGA, HDMI, USB, RJ-11, RJ-12, RJ-45 Cat.5E, 6, 6A, UTP, FTP, STP and SC/APT fiber optic adapters.



### ABB i-bus® KNX

Rooms with intelligence. Modern building automation has become more efficient than ever in order to meet the many demands of people working in the building. Adaptable systems turn the modern functional building into a smart building. They create an environment in which communication and creativity can freely express themselves. Ideal for efficiency, perfect for the future.



### Double pole switch

Offices are spaces with full activity during the whole day. This frenetic activity requires the intensive use of electrical devices. The double pole switches are specially designed to control the biggest loads of the electrical installation, such as the lighting of common areas, signaling panels, cooling and heating devices, etc.



### Dimmers for drivers

Always the perfect light in the meeting room. Full luminosity during the meeting, low light during a presentation. Dimmers for drivers are able to manage any lamp with a 1-10 Vdc input.



### Sound system

Webinars, video conference, on-line presentations... Many times a group of people is sharing a screen to participate in this type of meetings. These meeting rooms used to have a video system that can be shared, but what about the audio? Zenit's Sound System offers a perfect solution to share the audio of the laptop, tablet or mobile phone to all the audience in the room. Without cables, without auxiliary devices. Just connecting the laptop to the sound system via Bluetooth.

---

## The top in commercial spaces

To maximize customer experience

---

From a coffee shop to a modern mall.  
From the terrace to fitting room.  
From simple command centralizations to the most innovative ABB i-bus® KNX automation systems. Zenit and ABB solutions can transform the customer experience in any commercial environment. Design and functionality are key to creating a pleasant atmosphere, managing in the right way lighting and temperature, while keeping the wiring devices integrated in the overall decoration of the space.

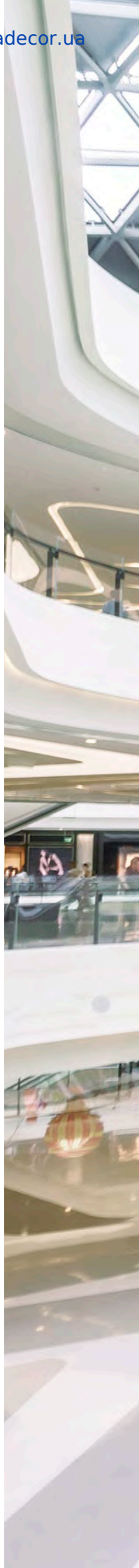



---

## Centralizations

Centralized control system. The systems for centralized control of Zenit are oriented to respond to the needs generated in facilities of the tertiary sector. In most of the tertiary installations, a place to centralize the control of the various lights, shutters, boilers, etc. is always required. The systems for centralized control of Zenit allows to group all these functions in a single box using the covers and inserts of most complete modular range of the market: Zenit.





#### ABB i-bus® KNX.

##### The perfect ally for big commercial areas.

Lighting and climate control are key to operating and maintaining commercial buildings such as big shopping malls. Balancing energy consumption and efficiency is the basis of a perfect customer experience and is important to stay profitable. ABB i-bus KNX is the intelligent installation system that meets the highest requirements for applications in modern building control and is based on the simple and proven KNX technology, which is accepted as the world's first open standard for the control of all types of intelligent buildings - industrial, commercial or residential.

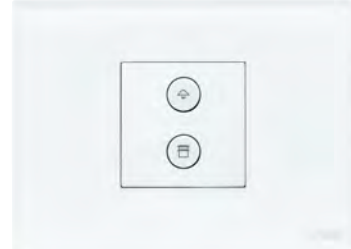

#### ABB-free@home® - The perfect partner for small shops, clinics, agencies or any small tertiary.

Free@home offers an endless number of possibilities for creative design. This allows the small commercial to be equipped in line with endless personal concepts and preferences. Both today and in the future. Easy to use and maintain, free@home can be easily managed by the owner without requiring special trainings. Maximum comfort and energy saving. Automation is the gateway to improve the customer experience by doing the right control of lighting and temperature and this is now also possible in small size commercial businesses thanks to ABB-free@home®.



#### Sound system

Hair salon, coffee shop, clothing store or dental clinic. All of them have in common the music. The music helps the customer to feel comfortable in the store while they are cutting the hair, taking a cup of tea, buying a shirt or waiting his turn in the waiting room. Zenit's Sound system is specially designed to meet any of the needs in these spaces, being easy to use and requiring simple installation.



#### Key switch

Protection against unauthorized access. The blind key switch/push-button prevents unauthorized operation of the electric drives. At home, it is suited as a "parental lock" and, at work, it prevents unauthorised persons from gaining access. Three different functions are available: key switch 1-way with 2 positions, key switch 2-way with 3 positions and a key push-button 1-way with 2 positions and automatic return to position 1.



#### All weather and surface solutions

Four options that cover any need in flush, surface and/or all weather installations. Zenit IP20 surface mounting boxes are the solution for a surface indoor installation keeping the aesthetic appearance in the store. Zenit IP40 boxes to give an industrial looking decoration inside the shop or if a surface solution in an indoor parking is needed. Zenit IP55 frames for flush mounting is the perfect ally to install a switch in the terrace of a bar, but mimicked with the furniture. Zenit IP55 surface mounting boxes will help in the installation of any device if the outdoor electrical installation is surface mounted.



#### Signaling and beacon lights

Zenit's signaling lights informs and discreetly provides clear orientation. A special field with a backlit pictogram marks the toilet, indicates smoke-free zones or provides information about special treatment rooms. Zenit's signaling lights are helpful everywhere. With a sufficient brightness (of two lux), Zenit's beacon light is ideal for lighting special danger points in dark areas. Particularly comforting: in case of a power failure, it is switched over to battery operation for up to three hours. The LEDs then maintain the lighting. For example, in stairwells or in cellars.

## Functions for all spaces

Zenit can be installed everywhere, in spaces that require new solutions, with new applications and all installation facilities.



### Up to 40% savings

- Contacts with an automatic connection terminal providing ease and up to 40% savings in installation time.
- The Zenit rocker mechanisms are 16 A and they offer top quality with a reduced number of reference to stock.
- More robust and compact mechanisms to be inserted from the front.
- Designed to hold the switches firmly avoiding balancing problems.
- They have reduced depth, only 21 mm, which allows more connection space for wires.
- With larger press clamps and smoother to make the automatic connection more comfortable and safer.
- They have been manufactured with high quality and recyclable material.



### More protection

- Children are really curious and get excited with any dangerous device available at home, especially those that are at the height of socket outlets.
- All Zenit socket outlets are equipped with shutters for child protection, protecting the live parts from electric shock.



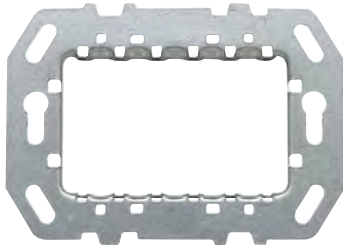

#### More benefits

- Galvanized steel mounting plates with unique anti-corrosion treatment with top and bottom nerves for a rigid positioning of the mechanism.
- The mounting plate is supplied separately from the frame in order to create the atmosphere you want.
- Zenit mechanisms are designed so they can be removed from the front.
- Galvanized steel metal mounting plate to ensure the durability of the installation.



#### Less consumption

- The covers are easily removed to change the lighting pilot facilitating the installation from the front.
- In Zenit we have replaced our traditional neon pilot for a LED located in the horizontal display that emits a diffused light; it looks more attractive; it consumes less energy and lasts 10 years.

#### Automatic connection



1. Strip the cable about 14 mm and introduce it into the terminal.



2. Press the push button and insert the cable.



3. Release the push button and check fixation. To disconnect the cord, press again the push button on top and bottom.

---

## Easy and intuitive installation system,

providing maximum values in performance, comfort and functionality in any market

### European installation

---

Switch composition in square box

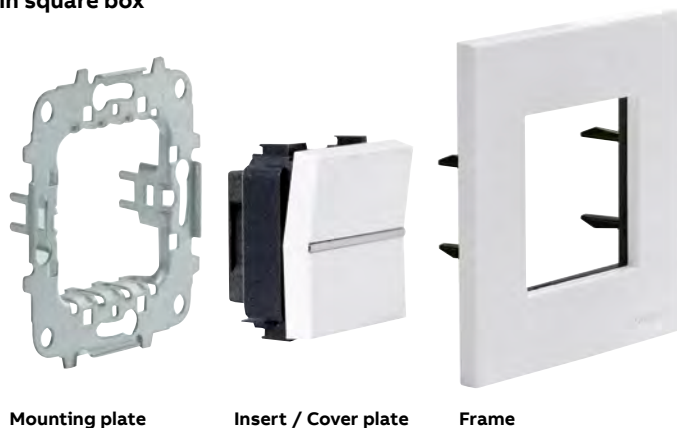

---

Schuko socket outlet composition in square box

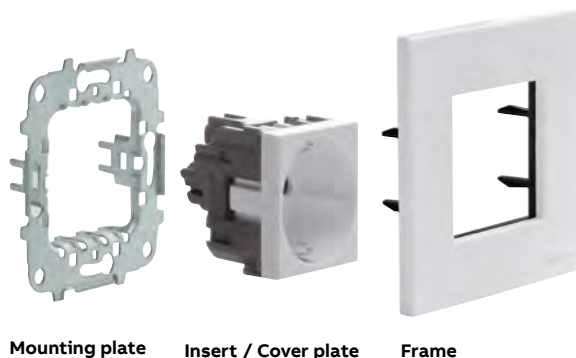

## Italian installation

### 4 module composition

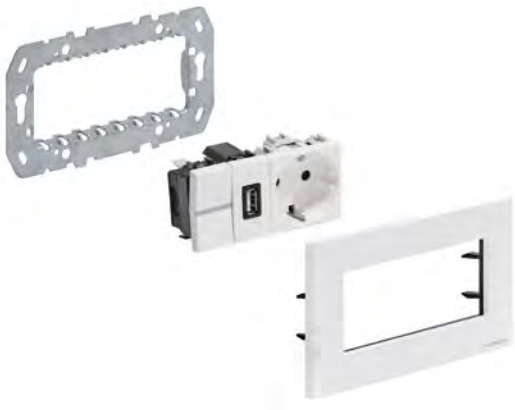

Mounting plate    Insert / Cover plate    Frame

## American installation

### Switch composition in rectangular box

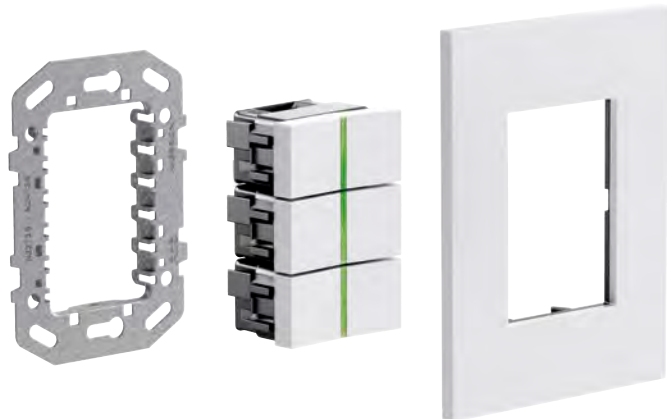

Mounting plate    Insert / Cover plate    Frame

### 7 module composition



Mounting plate    Insert / Cover plate    Frame

### NEMA socket outlet composition in rectangular box



Mounting plate    Insert / Cover plate    Frame



### Frame finishings

BL White

PL Silver

AN Anthracite

CV Champagne

CB White Glass

CN Black Glass

CF Graphite Glass

CH Champagne Glass

CP Pearl Glass

CC Coffee Glass

OX Stainless Steel

WG Wenge

PZ Slate

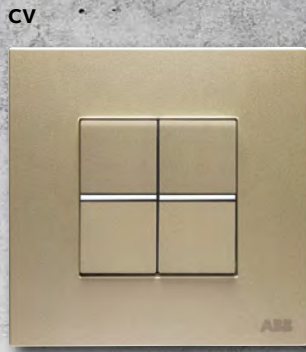
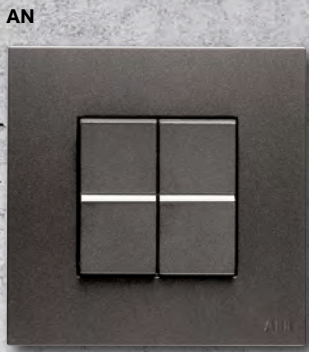

Device finishings

BB - Total White

BL - White

AA - Total Anthracite

AN - Anthracite

PL - Silver

CV - Champagne

.5 Green diffuser

.51 White diffuser

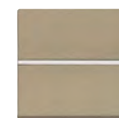
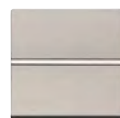

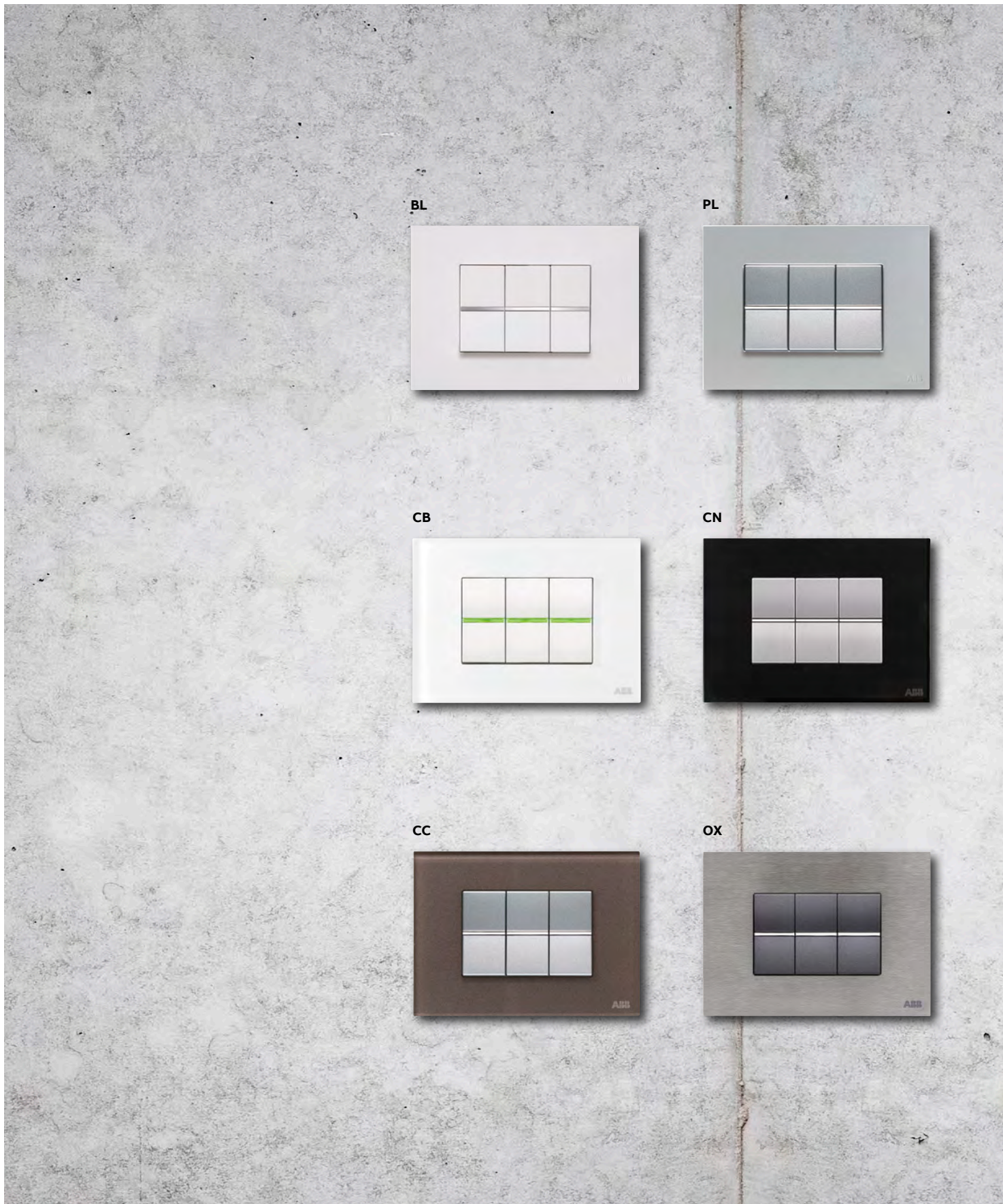

### Frame finishings

BL White

PL Silver

AN Anthracite

CV Champagne

CB White Glass

CN Black Glass

CF Graphite Glass

CH Champagne Glass

CP Pearl Glass

CC Coffee Glass

OX Stainless Steel

WG Wenge

PZ Slate

AN

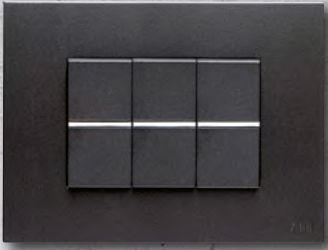

CV

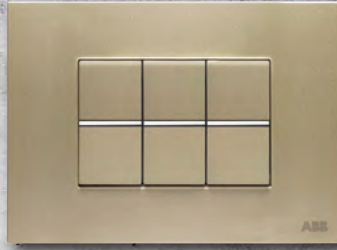

CF



CH



CP



WG



PZ



Device finishings

BB - Total White



BL - White



AA - Total Anthracite



AN - Anthracite

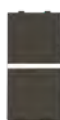

PL - Silver



CV - Champagne



.5 Green diffuser





.51 White diffuser





## Zenit

### 1-way switches

Color	Article-No.	Order-No.	Pack/Qty
	<b>Switch 1-gang, 1-way, SP - 1 M</b> Rated voltage: 110 - 250 Vac. Rated current: 16 AX. Rated power iLED (230/127 Vac): 200/100 W. Screwless terminals. Optional: locator LED lamp N2191.		
White	<b>N2101 BL</b>	2CLA210100N1101	20
Silver	<b>N2101 PL</b>	2CLA210100N1301	20
Anthracite	<b>N2101 AN</b>	2CLA210100N1801	20
Champagne	<b>N2101 CV</b>	2CLA210100N1901	20
Total White	<b>N2101 BB</b>	2CLA210100N1201	20
Total Anthracite	<b>N2101 AA</b>	2CLA210100N1601	20

	<b>Switch 1-gang, 1-way, SP - 1,5 M</b> Rated voltage: 110 - 250 Vac. Rated current: 16 AX. Rated power iLED (230/127 Vac): 200/100 W. Screwless terminals. Optional: locator LED lamp N2191.		
White	<b>N2801 BL</b>	2CLA280100N1101	10
Silver	<b>N2801 PL</b>	2CLA280100N1301	10
Anthracite	<b>N2801 AN</b>	2CLA280100N1801	10
Champagne	<b>N2801 CV</b>	2CLA280100N1901	10

	<b>Switch 1-gang, 1-way, SP - 2 M</b> Rated voltage: 110 - 250 Vac. Rated current: 16 AX. Rated power iLED (230/127 Vac): 200/100 W. Screwless terminals. Optional: locator LED lamp N2191.		
White	<b>N2201 BL</b>	2CLA220100N1101	10
Silver	<b>N2201 PL</b>	2CLA220100N1301	10
Anthracite	<b>N2201 AN</b>	2CLA220100N1801	10
Champagne	<b>N2201 CV</b>	2CLA220100N1901	10
Total White	<b>N2201 BB</b>	2CLA220100N1201	10
Total Anthracite	<b>N2201 AA</b>	2CLA220100N1601	10

	<b>Switch 1-gang, 1-way, SP - 3 M</b> Rated voltage: 110 - 250 Vac. Rated current: 16 AX. Rated power iLED (230/127 Vac): 200/100 W. Screwless terminals. Optional: locator LED lamp N2191.		
White	<b>N2301 BL</b>	2CLA230100N1101	10
Silver	<b>N2301 PL</b>	2CLA230100N1301	10
Anthracite	<b>N2301 AN</b>	2CLA230100N1801	10
Champagne	<b>N2301 CV</b>	2CLA230100N1901	10

### 2-way switches

Color	Article-No.	Order-No.	Pack/Qty
	<b>Switch 1-gang, 2-way, SP - 1 M</b> Rated voltage: 110 - 250 Vac. Rated current: 16 AX. Rated power iLED (230/127 Vac): 200/100 W. Screwless terminals. Optional: locator LED lamp N2192.		
White	<b>N2102 BL</b>	2CLA210200N1101	20
Silver	<b>N2102 PL</b>	2CLA210200N1301	20
Anthracite	<b>N2102 AN</b>	2CLA210200N1801	20
Champagne	<b>N2102 CV</b>	2CLA210200N1901	20
Total White	<b>N2102 BB</b>	2CLA210200N1201	20
Total Anthracite	<b>N2102 AA</b>	2CLA210200N1601	20

	<b>Switch 1-gang, 2-way, SP - 1,5 M</b> Rated voltage: 110 - 250 Vac. Rated current: 16 AX. Rated power iLED (230/127 Vac): 200/100 W. Screwless terminals. Optional: locator LED lamp N2192.		
White	<b>N2802 BL</b>	2CLA280200N1101	10
Silver	<b>N2802 PL</b>	2CLA280200N1301	10
Anthracite	<b>N2802 AN</b>	2CLA280200N1801	10
Champagne	<b>N2802 CV</b>	2CLA280200N1901	10

	<b>Switch 1-gang, 2-way, SP - 2 M</b> Rated voltage: 110 - 250 Vac. Rated current: 16 AX. Rated power iLED (230/127 Vac): 200/100 W. Screwless terminals. Optional: locator LED lamp N2192.		
White	<b>N2202 BL</b>	2CLA220200N1101	10
Silver	<b>N2202 PL</b>	2CLA220200N1301	10
Anthracite	<b>N2202 AN</b>	2CLA220200N1801	10
Champagne	<b>N2202 CV</b>	2CLA220200N1901	10
Total White	<b>N2202 BB</b>	2CLA220200N1201	10
Total Anthracite	<b>N2202 AA</b>	2CLA220200N1601	10

	<b>Switch 1-gang, 2-way, SP - 3 M</b> Rated voltage: 110 - 250 Vac. Rated current: 16 AX. Rated power iLED (230/127 Vac): 200/100 W. Screwless terminals. Optional: locator LED lamp N2192.		
White	<b>N2302 BL</b>	2CLA230200N1101	10
Silver	<b>N2302 PL</b>	2CLA230200N1301	10
Anthracite	<b>N2302 AN</b>	2CLA230200N1801	10
Champagne	<b>N2302 CV</b>	2CLA230200N1901	10





## Zenit

### Intermediate switches

Color	Article-No.	Order-No.	Pack/Qty
	<b>Switch 1-gang, intermediate, SP - 1 M</b> Rated voltage: 110 - 250 Vac. Rated current: 16 AX. Rated power iLED (230/127 Vac): 200/100 W. Screwless terminals. Optional: locator LED lamp N2192.		
White	<b>N2110 BL</b>	2CLA211000N1101	20
Silver	<b>N2110 PL</b>	2CLA211000N1301	20
Anthracite	<b>N2110 AN</b>	2CLA211000N1801	20
Champagne	<b>N2110 CV</b>	2CLA211000N1901	20
Total White	<b>N2110 BB</b>	2CLA211000N1201	20
Total Anthracite	<b>N2110 AA</b>	2CLA211000N1601	20

	<b>Switch 1-gang, intermediate, SP - 1,5 M</b> Rated voltage: 110 - 250 Vac. Rated current: 16 AX. Rated power iLED (230/127 Vac): 200/100 W. Screwless terminals. Optional: locator LED lamp N2192.		
White	<b>N2810 BL</b>	2CLA281000N1101	10
Silver	<b>N2810 PL</b>	2CLA281000N1301	10
Anthracite	<b>N2810 AN</b>	2CLA281000N1801	10
Champagne	<b>N2810 CV</b>	2CLA281000N1901	10

	<b>Switch 1-gang, intermediate, SP - 2 M</b> Rated voltage: 110 - 250 Vac. Rated current: 16 AX. Rated power iLED (230/127 Vac): 200/100 W. Screwless terminals. Optional: locator LED lamp N2192.		
White	<b>N2210 BL</b>	2CLA221000N1101	10
Silver	<b>N2210 PL</b>	2CLA221000N1301	10
Anthracite	<b>N2210 AN</b>	2CLA221000N1801	10
Champagne	<b>N2210 CV</b>	2CLA221000N1901	10
Total White	<b>N2210 BB</b>	2CLA221000N1201	10
Total Anthracite	<b>N2210 AA</b>	2CLA221000N1601	10

	<b>Switch 1-gang, intermediate, SP - 3 M</b> Rated voltage: 110 - 250 Vac. Rated current: 16 AX. Rated power iLED (230/127 Vac): 200/100 W. Screwless terminals. Optional: locator LED lamp N2192.		
White	<b>N2310 BL</b>	2CLA231000N1101	10
Silver	<b>N2310 PL</b>	2CLA231000N1301	10
Anthracite	<b>N2310 AN</b>	2CLA231000N1801	10
Champagne	<b>N2310 CV</b>	2CLA231000N1901	10

### Double pole switches

Color	Article-No.	Order-No.	Pack/Qty
	<b>Switch 1-gang, 1-way, DP - 1 M</b> Rated voltage: 110 - 250 Vac. Rated current: 16 AX. Rated power iLED (230/127 Vac): 200/100 W. Screwless terminals. Optional: locator LED lamp N2192.		
White	<b>N2101.2 BL</b>	2CLA210120N1101	20
Silver	<b>N2101.2 PL</b>	2CLA210120N1301	20
Anthracite	<b>N2101.2 AN</b>	2CLA210120N1801	20
Champagne	<b>N2101.2 CV</b>	2CLA210120N1901	20
Total White	<b>N2101.2 BB</b>	2CLA210120N1201	20
Total Anthracite	<b>N2101.2 AA</b>	2CLA210120N1601	20

	<b>Switch 1-gang, 1-way, DP - 2 M</b> Rated voltage: 110 - 250 Vac. Rated current: 16 AX. Rated power iLED (230/127 Vac): 200/100 W. Screwless terminals. Optional: locator LED lamp N2192.		
White	<b>N2201.2 BL</b>	2CLA220120N1101	10
Silver	<b>N2201.2 PL</b>	2CLA220120N1301	10
Anthracite	<b>N2201.2 AN</b>	2CLA220120N1801	10
Champagne	<b>N2201.2 CV</b>	2CLA220120N1901	10
Total White	<b>N2201.2 BB</b>	2CLA220120N1201	10
Total Anthracite	<b>N2201.2 AA</b>	2CLA220120N1601	10

	<b>Switch 1-gang, 1-way, DP, 32AX - 2 M</b> Rated voltage: 110 - 250 Vac. Rated current: 32AX. Screwless terminals.		
White	<b>N2201.8 BL</b>	2CLA220180N1101	5
Silver	<b>N2201.8 PL</b>	2CLA220180N1301	5
Anthracite	<b>N2201.8 AN</b>	2CLA220180N1801	5
Champagne	<b>N2201.8 CV</b>	2CLA220180N1901	5

	<b>Switch 1-gang, 2-way, DP - 1 M</b> Rated voltage: 110 - 250 Vac. Rated current: 16 AX. Rated power iLED (230/127 Vac): 200/100 W. Screwless terminals.		
White	<b>N2102.2 BL</b>	2CLA210220N1101	5
Silver	<b>N2102.2 PL</b>	2CLA210220N1301	5
Anthracite	<b>N2102.2 AN</b>	2CLA210220N1801	5
Champagne	<b>N2102.2 CV</b>	2CLA210220N1901	5

## Zenit

### Switches with indicator light

Color	Article-No.	Order-No.	Pack/Qty
	<b>Switch 1-gang, 1-way, SP - 1 M</b> Rated voltage: 110 - 250 Vac. Rated current: 16 AX. Rated power iLED (230/127 Vac): 200/100 W. Screwless terminals. 3 wires (Neutral conductor required). Included: indicator LED lamp N2192 RJ (230 Vac).		
White	<b>N2101.5 BL</b>	2CLA210150N1101	5
Silver	<b>N2101.5 PL</b>	2CLA210150N1301	5
Anthracite	<b>N2101.5 AN</b>	2CLA210150N1801	5
Champagne	<b>N2101.5 CV</b>	2CLA210150N1901	5

	<b>Switch 1-gang, 1-way, SP - 1 M</b> Rated voltage: 110 - 250 Vac. Rated current: 16 AX. Rated power iLED (230/127 Vac): 200/100 W. Rated power iLED (230/127 Vac): 200/100 W. Screwless terminals. 3 wires (Neutral conductor required). Included: indicator LED lamp N2192 BB (230 Vac).		
White-W	<b>N2101.51 BL</b>	2CLA210151N1201	5
Silver-W	<b>N2101.51 PL</b>	2CLA210151N1101	5
Anthracite-W	<b>N2101.51 AN</b>	2CLA210151N1601	5
Champagne-W	<b>N2101.51 CV</b>	2CLA210151N1901	5

	<b>Switch 1-gang, 1-way, SP - 2 M</b> Rated voltage: 110 - 250 Vac. Rated current: 16 AX. Rated power iLED (230/127 Vac): 200/100 W. Screwless terminals. 3 wires (Neutral conductor required). Included: indicator LED lamp N2192 RJ (230 Vac).		
White	<b>N2201.5 BL</b>	2CLA220150N1101	5
Silver	<b>N2201.5 PL</b>	2CLA220150N1301	5
Anthracite	<b>N2201.5 AN</b>	2CLA220150N1801	5
Champagne	<b>N2201.5 CV</b>	2CLA220150N1901	5

	<b>Switch 1-gang, 1-way, SP - 2 M</b> Rated voltage: 110 - 250 Vac. Rated current: 16 AX. Rated power iLED (230/127 Vac): 200/100 W. Screwless terminals. 3 wires (Neutral conductor required). Included: indicator LED lamp N2192 BB (230 Vac).		
White-W	<b>N2201.51 BL</b>	2CLA220151N1201	5
Silver-W	<b>N2201.51 PL</b>	2CLA220151N1101	5
Anthracite-W	<b>N2201.51 AN</b>	2CLA220151N1601	5
Champagne-W	<b>N2201.51 CV</b>	2CLA220151N1901	5

Color	Article-No.	Order-No.	Pack/Qty
	<b>Switch 1-gang, 2-way, SP - 1 M</b> Rated voltage: 110 - 250 Vac. Rated current: 16 AX. Rated power iLED (230/127 Vac): 200/100 W. Screwless terminals. 4 wires (Neutral conductor required). Included: indicator LED lamp N2191 VD (230 Vac).		
White	<b>N2102.5 BL</b>	2CLA210250N1101	5
Silver	<b>N2102.5 PL</b>	2CLA210250N1301	5
Anthracite	<b>N2102.5 AN</b>	2CLA210250N1801	5
Champagne	<b>N2102.5 CV</b>	2CLA210250N1901	5

	<b>Switch 1-gang, 2-way, SP - 1 M</b> Rated voltage: 110 - 250 Vac. Rated current: 16 AX. Rated power iLED (230/127 Vac): 200/100 W. Screwless terminals. 4 wires (Neutral conductor required). Included: indicator LED lamp N2191 BB (230 Vac).		
White-W	<b>N2102.51 BL</b>	2CLA210251N1201	5
Silver-W	<b>N2102.51 PL</b>	2CLA210251N1101	5
Anthracite-W	<b>N2102.51 AN</b>	2CLA210251N1601	5
Champagne-W	<b>N2102.51 CV</b>	2CLA210251N1901	5

	<b>Switch 1-gang, 2-way, SP - 2 M</b> Rated voltage: 110 - 250 Vac. Rated current: 16 AX. Rated power iLED (230/127 Vac): 200/100 W. Screwless terminals. 4 wires (Neutral conductor required). Included: indicator LED lamp N2191 VD (230 Vac).		
White	<b>N2202.5 BL</b>	2CLA220250N1101	5
Silver	<b>N2202.5 PL</b>	2CLA220250N1301	5
Anthracite	<b>N2202.5 AN</b>	2CLA220250N1801	5
Champagne	<b>N2202.5 CV</b>	2CLA220250N1901	5

	<b>Switch 1-gang, 2-way, SP - 2 M</b> Rated voltage: 110 - 250 Vac. Rated current: 16 AX. Rated power iLED (230/127 Vac): 200/100 W. Screwless terminals. 4 wires (Neutral conductor required). Included: indicator LED lamp N2191 BB (230 Vac).		
White-W	<b>N2202.51 BL</b>	2CLA220251N1201	5
Silver-W	<b>N2202.51 PL</b>	2CLA220251N1101	5
Anthracite-W	<b>N2202.51 AN</b>	2CLA220251N1601	5
Champagne-W	<b>N2202.51 CV</b>	2CLA220251N1901	5

## Zenit

### Switches with indicator light

Color	Article-No.	Order-No.	Pack/Qty
	<b>Push-button, SP without symbol - 1M</b> Rated voltage: 110 - 250 Vac. Rated current: 16A. Screwless terminals. 3 wires (Neutral conductor required). Included: indicator LED lamp N2192 RJ (230 Vac).		
White	<b>N2104.5 BL</b>	2CLA210450N1101	5
Silver	<b>N2104.5 PL</b>	2CLA210450N1301	5
Anthracite	<b>N2104.5 AN</b>	2CLA210450N1801	5
Champagne	<b>N2104.5 CV</b>	2CLA210450N1901	5

	<b>Push-button, SP without symbol - 1M</b> Rated voltage: 110 - 250 Vac. Rated current: 16A. Screwless terminals. 3 wires (Neutral conductor required). Included: indicator LED lamp N2192 BB (230 Vac).		
White-W	<b>N2104.51 BL</b>	2CLA210451N1201	5
Silver-W	<b>N2104.51 PL</b>	2CLA210451N1101	5
Anthracite-W	<b>N2104.51 AN</b>	2CLA210451N1601	5
Champagne-W	<b>N2104.51 CV</b>	2CLA210451N1901	5

Color	Article-No.	Order-No.	Pack/Qty
	<b>Push-button, SP without symbol - 2M</b> Rated voltage: 110 - 250 Vac. Rated current: 16A. Screwless terminals. 3 wires (Neutral conductor required). Included: indicator LED lamp N2192 RJ (230 Vac).		
White	<b>N2204.5 BL</b>	2CLA220450N1101	5
Silver	<b>N2204.5 PL</b>	2CLA220450N1301	5
Anthracite	<b>N2204.5 AN</b>	2CLA220450N1801	5
Champagne	<b>N2204.5 CV</b>	2CLA220450N1901	5

	<b>Push-button, SP without symbol - 2M</b> Rated voltage: 110 - 250 Vac. Rated current: 16A. Screwless terminals. 3 wires (Neutral conductor required). Included: indicator LED lamp N2192 BB (230 Vac).		
White-W	<b>N2204.51 BL</b>	2CLA220451N1201	5
Silver-W	<b>N2204.51 PL</b>	2CLA220451N1101	5
Anthracite-W	<b>N2204.51 AN</b>	2CLA220451N1601	5
Champagne-W	<b>N2204.51 CV</b>	2CLA220451N1901	5

## Zenit

### Push buttons

Color	Article-No.	Order-No.	Pack/Qty
	<b>Push-button, SP with bell symbol - 1M</b> Rated voltage: 110 - 250 Vac. Rated current: 16A. Screwless terminals. 1-gang, 1-way - Normally Opened (NO) contact. Optional: locator LED lamp N2191.		
White	<b>N2104 BL</b>	2CLA210400N1101	20
Silver	<b>N2104 PL</b>	2CLA210400N1301	20
Anthracite	<b>N2104 AN</b>	2CLA210400N1801	20
Champagne	<b>N2104 CV</b>	2CLA210400N1901	20

	<b>Push-button, SP with bell symbol - 2M</b> Rated voltage: 110 - 250 Vac. Rated current: 16A. Screwless terminals. 1-gang, 1-way - Normally Opened (NO) contact. Optional: locator LED lamp N2191.		
White	<b>N2204 BL</b>	2CLA220400N1101	10
Silver	<b>N2204 PL</b>	2CLA220400N1301	10
Anthracite	<b>N2204 AN</b>	2CLA220400N1801	10
Champagne	<b>N2204 CV</b>	2CLA220400N1901	10

	<b>Push-button, SP with bell symbol - 3M</b> Rated voltage: 110 - 250 Vac. Rated current: 16A. Screwless terminals. 1-gang, 1-way - Normally Opened (NO) contact. Optional: locator LED lamp N2191.		
White	<b>N2304 BL</b>	2CLA230400N1101	10
Silver	<b>N2304 PL</b>	2CLA230400N1301	10
Anthracite	<b>N2304 AN</b>	2CLA230400N1801	10
Champagne	<b>N2304 CV</b>	2CLA230400N1901	10

Color	Article-No.	Order-No.	Pack/Qty
	<b>Push-button, SP with light symbol - 1M</b> Rated voltage: 110 - 250 Vac. Rated current: 16A. Screwless terminals. 1-gang, 1-way - Normally Opened (NO) contact. Optional: locator LED lamp N2191.		
White	<b>N2104.2 BL</b>	2CLA210420N1101	20
Silver	<b>N2104.2 PL</b>	2CLA210420N1301	20
Anthracite	<b>N2104.2 AN</b>	2CLA210420N1801	20
Champagne	<b>N2104.2 CV</b>	2CLA210420N1901	20

	<b>Push-button, SP with light symbol - 2M</b> Rated voltage: 110 - 250 Vac. Rated current: 16A. Screwless terminals. 1-gang, 1-way - Normally Opened (NO) contact. Optional: locator LED lamp N2191.		
White	<b>N2204.2 BL</b>	2CLA220420N1101	10
Silver	<b>N2204.2 PL</b>	2CLA220420N1301	10
Anthracite	<b>N2204.2 AN</b>	2CLA220420N1801	10
Champagne	<b>N2204.2 CV</b>	2CLA220420N1901	10

	<b>Push-button, NC, SP without symbol - 1M</b> Rated voltage: 110 - 250 Vac. Rated current: 16A. Screwless terminals. 1-gang, 1-way - Normally Closed (NC) contact. Locator lamp option not available.		
White	<b>N2104.6 BL</b>	2CLA210460N1101	5
Silver	<b>N2104.6 PL</b>	2CLA210460N1301	5
Anthracite	<b>N2104.6 AN</b>	2CLA210460N1801	5
Champagne	<b>N2104.6 CV</b>	2CLA210460N1901	5
Total White	<b>N2104.6 BB</b>	2CLA210460N1201	5
Total Anthracite	<b>N2104.6 AA</b>	2CLA210460N1601	5

	<b>Push-button, NC, SP without symbol - 2M</b> Rated voltage: 110 - 250 Vac. Rated current: 16A. Screwless terminals. 1-gang, 1-way - Normally Closed (NC) contact Locator lamp option not available.		
White	<b>N2204.6 BL</b>	2CLA220460N1101	5
Silver	<b>N2204.6 PL</b>	2CLA220460N1301	5
Anthracite	<b>N2204.6 AN</b>	2CLA220460N1801	5
Champagne	<b>N2204.6 CV</b>	2CLA220460N1901	5
Total White	<b>N2204.6 BB</b>	2CLA220460N1201	5
Total Anthracite	<b>N2204.6 AA</b>	2CLA220460N1601	5

## Zenit

### Push buttons

Color	Article-No.	Order-No.	Pack/Qty
	<b>Push-button, SP without symbol - 1M</b> Rated voltage: 110 - 250 Vac. Rated current: 16A. Screwless terminals. 1-gang, 1-way - Normally Opened (NO) contact. Optional: locator LED lamp N2191.		

White	<b>N2104.7 BL</b>	2CLA210470N1101	20
Silver	<b>N2104.7 PL</b>	2CLA210470N1301	20
Anthracite	<b>N2104.7 AN</b>	2CLA210470N1801	20
Champagne	<b>N2104.7 CV</b>	2CLA210470N1901	20
Total White	<b>N2104.7 BB</b>	2CLA210470N1201	20
Total Anthracite	<b>N2104.7 AA</b>	2CLA210470N1601	20

	<b>Push-button, SP without symbol - 2M</b> Rated voltage: 110 - 250 Vac. Rated current: 16A. Screwless terminals. 1-gang, 1-way - Normally Opened (NO) contact. Optional: locator LED lamp N2191.		
---	--	--	--

White	<b>N2204.7 BL</b>	2CLA220470N1101	10
Silver	<b>N2204.7 PL</b>	2CLA220470N1301	10
Anthracite	<b>N2204.7 AN</b>	2CLA220470N1801	10
Champagne	<b>N2204.7 CV</b>	2CLA220470N1901	10
Total White	<b>N2204.7 BB</b>	2CLA220470N1201	10
Total Anthracite	<b>N2204.7 AA</b>	2CLA220470N1601	10

	<b>Push-button, SP with label holder - 2M</b> Rated voltage: 110 - 250 Vac. Rated current: 16A. Screwless terminals. 1-gang, 1-way - Normally Opened (NO) contact. Optional: locator LED lamp N2191.		
---	---	--	--

White	<b>N2204.8 BL</b>	2CLA220480N1101	10
Silver	<b>N2204.8 PL</b>	2CLA220480N1301	10
Anthracite	<b>N2204.8 AN</b>	2CLA220480N1801	10
Champagne	<b>N2204.8 CV</b>	2CLA220480N1901	10

### Rocker covers with backlit symbol housing

Color	Article-No.	Order-No.	Pack/Qty
	<b>Rocker cover with symbol housing - 1M</b> Spare rocker cover with housing for N2004.X symbols. Suitable for N2101.X, N2102.X, N2110 and N2104.X inserts.		





White	<b>N2101.9 BL</b>	2CLA210190N1101	10
Silver	<b>N2101.9 PL</b>	2CLA210190N1301	10
Anthracite	<b>N2101.9 AN</b>	2CLA210190N1801	10
Champagne	<b>N2101.9 CV</b>	2CLA210190N1901	10

	<b>Rocker cover with symbol housing - 2M</b> Spare rocker cover with housing for N2004.X symbols. Suitable for N2201.X, N2202.X, N2210 and N2204.X inserts.		
---	---	--	--

White	<b>N2201.9 BL</b>	2CLA220190N1101	10
Silver	<b>N2201.9 PL</b>	2CLA220190N1301	10
Anthracite	<b>N2201.9 AN</b>	2CLA220190N1801	10
Champagne	<b>N2201.9 CV</b>	2CLA220190N1901	10

	<b>Rocker cover with symbol housing - 3M</b> Spare rocker cover with housing for N2004.X symbols. Suitable for N2301, N2302, N2310 and N2304 inserts.		
---	---	--	--

White	<b>N2301.9 BL</b>	2CLA230190N1101	5
Silver	<b>N2301.9 PL</b>	2CLA230190N1301	5
Anthracite	<b>N2301.9 AN</b>	2CLA230190N1801	5
Champagne	<b>N2301.9 CV</b>	2CLA230190N1901	5

<b>Backlit symbols</b> Symbols for N2X01.9 rocker covers.			
			
			
			
			

Key symbol	<b>N2004.1</b>	2CLA200410N1101	10
Fan symbol	<b>N2004.2</b>	2CLA200420N1101	10
WC symbol	<b>N2004.3</b>	2CLA200430N1101	10
Room service symbol	<b>N2004.4</b>	2CLA200440N1101	10
Nurse symbol	<b>N2004.5</b>	2CLA200450N1101	10
Dot symbol	<b>N2004.6</b>	2CLA200460N1101	10

## Zenit

### Rocker covers with engraved symbols

Color	Article-No.	Order-No.	Pack/Qty
 <p><b>Rocker cover without symbol - 1M</b> Spare rocker cover without decorative trim. Suitable for N2101.X, N2102.X, N2110 and N2104.X inserts.</p>			
White	<b>N2109 BL</b>	2CLA210900N1101	10
Silver	<b>N2109 PL</b>	2CLA210900N1301	10
Anthracite	<b>N2109 AN</b>	2CLA210900N1801	10
Champagne	<b>N2109 CV</b>	2CLA210900N1901	10

 <p><b>Rocker cover without symbol - 2M</b> Spare rocker cover without decorative trim. Suitable for N2201.X, N2202.X, N2210 and N2204.X inserts.</p>			
White	<b>N2209 BL</b>	2CLA220900N1101	10
Silver	<b>N2209 PL</b>	2CLA220900N1301	10
Anthracite	<b>N2209 AN</b>	2CLA220900N1801	10
Champagne	<b>N2209 CV</b>	2CLA220900N1901	10

 <p><b>Rocker cover with nurse symbol - 1M</b> Spare rocker cover without decorative trim. Suitable for N2101.X, N2102.X, N2110 and N2104.X inserts.</p>			
White	<b>N2109.01 BL</b>	2CLA210901N1101	10
Silver	<b>N2109.01 PL</b>	2CLA210901N1301	10
Anthracite	<b>N2109.01 AN</b>	2CLA210901N1801	10
Champagne	<b>N2109.01 CV</b>	2CLA210901N1901	10

 <p><b>Rocker cover with nurse symbol - 2M</b> Spare rocker cover without decorative trim. Suitable for N2201.X, N2202.X, N2210 and N2204.X inserts.</p>			
White	<b>N2209.01 BL</b>	2CLA220901N1101	10
Silver	<b>N2209.01 PL</b>	2CLA220901N1301	10
Anthracite	<b>N2209.01 AN</b>	2CLA220901N1801	10
Champagne	<b>N2209.01 CV</b>	2CLA220901N1901	10

Color	Article-No.	Order-No.	Pack/Qty
 <p><b>Rocker cover with lamp symbol - 1M</b> Spare rocker cover without decorative trim. Suitable for N2101.X, N2102.X, N2110 and N2104.X inserts.</p>			
White	<b>N2109.02 BL</b>	2CLA210902N1101	10
Silver	<b>N2109.02 PL</b>	2CLA210902N1301	10
Anthracite	<b>N2109.02 AN</b>	2CLA210902N1801	10
Champagne	<b>N2109.02 CV</b>	2CLA210902N1901	10

 <p><b>Rocker cover with lamp symbol - 2M</b> Spare rocker cover without decorative trim. Suitable for N2201.X, N2202.X, N2210 and N2204.X inserts.</p>			
White	<b>N2209.02 BL</b>	2CLA220902N1101	10
Silver	<b>N2209.02 PL</b>	2CLA220902N1301	10
Anthracite	<b>N2209.02 AN</b>	2CLA220902N1801	10
Champagne	<b>N2209.02 CV</b>	2CLA220902N1901	10

 <p><b>Rocker cover with dimmer symbol - 1M</b> Spare rocker cover without decorative trim. Suitable for N2101.X, N2102.X, N2110 and N2104.X inserts.</p>			
White	<b>N2109.03 BL</b>	2CLA210903N1101	10
Silver	<b>N2109.03 PL</b>	2CLA210903N1301	10
Anthracite	<b>N2109.03 AN</b>	2CLA210903N1801	10
Champagne	<b>N2109.03 CV</b>	2CLA210903N1901	10

 <p><b>Rocker cover with dimmer symbol - 2M</b> Spare rocker cover without decorative trim. Suitable for N2201.X, N2202.X, N2210 and N2204.X inserts.</p>			
White	<b>N2209.03 BL</b>	2CLA220903N1101	10
Silver	<b>N2209.03 PL</b>	2CLA220903N1301	10
Anthracite	<b>N2209.03 AN</b>	2CLA220903N1801	10
Champagne	<b>N2209.03 CV</b>	2CLA220903N1901	10

## Zenit

### Rocker covers with engraved symbols

Color	Article-No.	Order-No.	Pack/Qty
 <p><b>Rocker cover with fan symbol - 1M</b> Spare rocker cover without decorative trim. Suitable for N2101.X, N2102.X, N2110 and N2104.X inserts.</p>			
White	<b>N2109.04 BL</b>	2CLA210904N1101	10
Silver	<b>N2109.04 PL</b>	2CLA210904N1301	10
Anthracite	<b>N2109.04 AN</b>	2CLA210904N1801	10
Champagne	<b>N2109.04 CV</b>	2CLA210904N1901	10

 <p><b>Rocker cover with fan symbol - 2M</b> Spare rocker cover without decorative trim. Suitable for N2201.X, N2202.X, N2210 and N2204.X inserts.</p>			
White	<b>N2209.04 BL</b>	2CLA220904N1101	10
Silver	<b>N2209.04 PL</b>	2CLA220904N1301	10
Anthracite	<b>N2209.04 AN</b>	2CLA220904N1801	10
Champagne	<b>N2209.04 CV</b>	2CLA220904N1901	10

 <p><b>Rocker cover with telephone symbol - 1M</b> Spare rocker cover without decorative trim. Suitable for N2101.X, N2102.X, N2110 and N2104.X inserts.</p>			
White	<b>N2109.05 BL</b>	2CLA210905N1101	10
Silver	<b>N2109.05 PL</b>	2CLA210905N1301	10
Anthracite	<b>N2109.05 AN</b>	2CLA210905N1801	10
Champagne	<b>N2109.05 CV</b>	2CLA210905N1901	10

 <p><b>Rocker cover with telephone symbol - 2M</b> Spare rocker cover without decorative trim. Suitable for N2201.X, N2202.X, N2210 and N2204.X inserts.</p>			
White	<b>N2209.05 BL</b>	2CLA220905N1101	10
Silver	<b>N2209.05 PL</b>	2CLA220905N1301	10
Anthracite	<b>N2209.05 AN</b>	2CLA220905N1801	10
Champagne	<b>N2209.05 CV</b>	2CLA220905N1901	10

Color	Article-No.	Order-No.	Pack/Qty
 <p><b>Rocker cover with open symbol - 1M</b> Spare rocker cover without decorative trim. Suitable for N2101.X, N2102.X, N2110 and N2104.X inserts.</p>			
White	<b>N2109.06 BL</b>	2CLA210906N1101	10
Silver	<b>N2109.06 PL</b>	2CLA210906N1301	10
Anthracite	<b>N2109.06 AN</b>	2CLA210906N1801	10
Champagne	<b>N2109.06 CV</b>	2CLA210906N1901	10

 <p><b>Rocker cover with open symbol - 2M</b> Spare rocker cover without decorative trim. Suitable for N2201.X, N2202.X, N2210 and N2204.X inserts.</p>			
White	<b>N2209.06 BL</b>	2CLA220906N1101	10
Silver	<b>N2209.06 PL</b>	2CLA220906N1301	10
Anthracite	<b>N2209.06 AN</b>	2CLA220906N1801	10
Champagne	<b>N2209.06 CV</b>	2CLA220906N1901	10

 <p><b>Rocker cover with close symbol - 1M</b> Spare rocker cover without decorative trim. Suitable for N2101.X, N2102.X, N2110 and N2104.X inserts.</p>			
White	<b>N2109.07 BL</b>	2CLA210907N1101	10
Silver	<b>N2109.07 PL</b>	2CLA210907N1301	10
Anthracite	<b>N2109.07 AN</b>	2CLA210907N1801	10
Champagne	<b>N2109.07 CV</b>	2CLA210907N1901	10

 <p><b>Rocker cover with close symbol - 2M</b> Spare rocker cover without decorative trim. Suitable for N2201.X, N2202.X, N2210 and N2204.X inserts.</p>			
White	<b>N2209.07 BL</b>	2CLA220907N1101	10
Silver	<b>N2209.07 PL</b>	2CLA220907N1301	10
Anthracite	<b>N2209.07 AN</b>	2CLA220907N1801	10
Champagne	<b>N2209.07 CV</b>	2CLA220907N1901	10

## Zenit

### Rocker covers with engraved symbols

Color	Article-No.	Order-No.	Pack/Qty
 <p><b>Rocker cover with OFF symbol - 1M</b> Spare rocker cover without decorative trim. Suitable for N2101.X, N2102.X, N2110 and N2104.X inserts.</p>			
White	<b>N2109.08 BL</b>	2CLA210908N1101	10
Silver	<b>N2109.08 PL</b>	2CLA210908N1301	10
Anthracite	<b>N2109.08 AN</b>	2CLA210908N1801	10
Champagne	<b>N2109.08 CV</b>	2CLA210908N1901	10

 <p><b>Rocker cover with OFF symbol - 2M</b> Spare rocker cover without decorative trim. Suitable for N2201.X, N2202.X, N2210 and N2204.X inserts.</p>			
White	<b>N2209.08 BL</b>	2CLA220908N1101	10
Silver	<b>N2209.08 PL</b>	2CLA220908N1301	10
Anthracite	<b>N2209.08 AN</b>	2CLA220908N1801	10
Champagne	<b>N2209.08 CV</b>	2CLA220908N1901	10

 <p><b>Rocker cover with DND symbol - 1M</b> Spare rocker cover without decorative trim. Suitable for N2101.X, N2102.X, N2110 and N2104.X inserts.</p>			
White	<b>N2109.09 BL</b>	2CLA210909N1101	10
Silver	<b>N2109.09 PL</b>	2CLA210909N1301	10
Anthracite	<b>N2109.09 AN</b>	2CLA210909N1801	10
Champagne	<b>N2109.09 CV</b>	2CLA210909N1901	10

 <p><b>Rocker cover with DND symbol - 2M</b> Spare rocker cover without decorative trim. Suitable for N2201.X, N2202.X, N2210 and N2204.X inserts.</p>			
White	<b>N2209.09 BL</b>	2CLA220909N1101	10
Silver	<b>N2209.09 PL</b>	2CLA220909N1301	10
Anthracite	<b>N2209.09 AN</b>	2CLA220909N1801	10
Champagne	<b>N2209.09 CV</b>	2CLA220909N1901	10

Color	Article-No.	Order-No.	Pack/Qty
 <p><b>Rocker cover with MUR symbol - 1M</b> Spare rocker cover without decorative trim. Suitable for N2101.X, N2102.X, N2110 and N2104.X inserts.</p>			
White	<b>N2109.10 BL</b>	2CLA210910N1101	10
Silver	<b>N2109.10 PL</b>	2CLA210910N1301	10
Anthracite	<b>N2109.10 AN</b>	2CLA210910N1801	10
Champagne	<b>N2109.10 CV</b>	2CLA210910N1901	10

 <p><b>Rocker cover with MUR symbol - 2M</b> Spare rocker cover without decorative trim. Suitable for N2201.X, N2202.X, N2210 and N2204.X inserts.</p>			
White	<b>N2209.10 BL</b>	2CLA220910N1101	10
Silver	<b>N2209.10 PL</b>	2CLA220910N1301	10
Anthracite	<b>N2209.10 AN</b>	2CLA220910N1801	10
Champagne	<b>N2209.10 CV</b>	2CLA220910N1901	10

 <p><b>Rocker cover with light symbol - 1M</b> Spare rocker cover without decorative trim. Suitable for N2101.X, N2102.X, N2110 and N2104.X inserts.</p>			
White	<b>N2109.11 BL</b>	2CLA210911N1101	10
Silver	<b>N2109.11 PL</b>	2CLA210911N1301	10
Anthracite	<b>N2109.11 AN</b>	2CLA210911N1801	10
Champagne	<b>N2109.11 CV</b>	2CLA210911N1901	10

 <p><b>Rocker cover with light symbol - 2M</b> Spare rocker cover without decorative trim. Suitable for N2201.X, N2202.X, N2210 and N2204.X inserts.</p>			
White	<b>N2209.11 BL</b>	2CLA220911N1101	10
Silver	<b>N2209.11 PL</b>	2CLA220911N1301	10
Anthracite	<b>N2209.11 AN</b>	2CLA220911N1801	10
Champagne	<b>N2209.11 CV</b>	2CLA220911N1901	10



## Zenit

### Card switches

Color	Article-No.	Order-No.	Pack/Qty
 <p><b>Card switch 1-gang, 1-way, DP - 2M</b>            Rated voltage: 110 - 250 Vac.            Rated current: 16 AX.            Rated power iLED (230/127 Vac): 200/100 W.            For 54mm width cards.            Included: locator LED lamp N2193 NG (230 Vac).</p>			
White	<b>N2214.1 BL</b>	2CLA221410N1101	10
Silver	<b>N2214.1 PL</b>	2CLA221410N1301	10
Anthracite	<b>N2214.1 AN</b>	2CLA221410N1801	10
Champagne	<b>N2214.1 CV</b>	2CLA221410N1901	10

 <p><b>Card timer switch 1-gang, 1-way, SP - 2M</b>            Rated current (230Vac / 127Vac):            - Incandescent/halogen: 3.000W / 1.600W.            - Fluorescent: 1.300VA / 700VA.            - Electronic and ferromag. transf. and motors: 3.000VA / 1.600VA.            For 54mm width cards.            Locator LED lamp included.            Time delayed switch: 5 - 90 seconds.</p>			
White	<b>N2214.5 BL</b>	2CLA221450N1101	1
Silver	<b>N2214.5 PL</b>	2CLA221450N1301	1
Anthracite	<b>N2214.5 AN</b>	2CLA221450N1801	1
Champagne	<b>N2214.5 CV</b>	2CLA221450N1901	1

### Pullcord switches

 <p><b>Pullcord switch 1-gang, 1-way, SP - 1M</b>            Rated voltage: 110 - 250 Vac.            Rated current: 16A.            Screwless terminals.            Cord length: 2 meters.</p>			
White	<b>N2148 BL</b>	2CLA214800N1101	5
Silver	<b>N2148 PL</b>	2CLA214800N1301	5
Anthracite	<b>N2148 AN</b>	2CLA214800N1801	5
Champagne	<b>N2148 CV</b>	2CLA214800N1901	5
Total White	<b>N2148 BB</b>	2CLA214800N1201	5
Total Anthracite	<b>N2148 AA</b>	2CLA214800N1601	5

 <p><b>Pullcord switch 1-gang, 1-way, SP - 2M</b>            Rated voltage: 110 - 250 Vac.            Rated current: 16A.            Screwless terminals.            Cord length: 2 meters.</p>			
White	<b>N2248 BL</b>	2CLA224800N1101	5
Silver	<b>N2248 PL</b>	2CLA224800N1301	5
Anthracite	<b>N2248 AN</b>	2CLA224800N1801	5
Champagne	<b>N2248 CV</b>	2CLA224800N1901	5

### Key switches

Color	Article-No.	Order-No.	Pack/Qty
 <p><b>Key switch 2-way, 3 positions, SP - 1M</b>            Rated voltage: 110 - 250 Vac.            Rated current: 5A.            Key removable in the 3 positions.            Unique key for each lock.            Suitable for blinds, shutters, etc.</p>			
White	<b>N2153.1 BL</b>	2CLA215310N1101	1
Silver	<b>N2153.1 PL</b>	2CLA215310N1301	1
Anthracite	<b>N2153.1 AN</b>	2CLA215310N1801	1
Champagne	<b>N2153.1 CV</b>	2CLA215310N1901	1

 <p><b>Key switch 1-way, 2 positions, SP - 2M</b>            Rated voltage: 110 - 250 Vac.            Rated current: 5A.            Key removable in the 2 positions.            Unique key for each lock.            Suitable for alarms.</p>			
White	<b>N2253 BL</b>	2CLA225300N1101	1
Silver	<b>N2253 PL</b>	2CLA225300N1301	1
Anthracite	<b>N2253 AN</b>	2CLA225300N1801	1
Champagne	<b>N2253 CV</b>	2CLA225300N1901	1

 <p><b>Key switch 2-way, 3 positions, SP - 2M</b>            Rated voltage: 110 - 250 Vac.            Rated current: 150mA.            Key removable in "OFF" position.            Unique key for each lock.            Suitable for blinds, shutters, etc.</p>			
White	<b>N2253.1 BL</b>	2CLA225310N1101	1
Silver	<b>N2253.1 PL</b>	2CLA225310N1301	1
Anthracite	<b>N2253.1 AN</b>	2CLA225310N1801	1
Champagne	<b>N2253.1 CV</b>	2CLA225310N1901	1

 <p><b>Key push-button 1-way, 2 positions, SP - 2M</b>            Rated voltage: 110 - 250 Vac.            Rated current: 5A.            Key removable in "OFF" position.            Unique key for each lock.            Suitable for alarms.</p>			
White	<b>N2253.2 BL</b>	2CLA225320N1101	1
Silver	<b>N2253.2 PL</b>	2CLA225320N1301	1
Anthracite	<b>N2253.2 AN</b>	2CLA225320N1801	1
Champagne	<b>N2253.2 CV</b>	2CLA225320N1901	1

## Zenit

### Blind controls

Color	Article-No.	Order-No.	Pack/Qty
-------	-------------	-----------	----------



#### Push-button blind control 1-gang - 1M

Rated voltage: 110 - 250 Vac.  
Rated current: 10A.  
Direct control.

White	<b>N2144 BL</b>	2CLA214400N1101	5
Silver	<b>N2144 PL</b>	2CLA214400N1301	5
Anthracite	<b>N2144 AN</b>	2CLA214400N1801	5
Champagne	<b>N2144 CV</b>	2CLA214400N1901	5
Total White	<b>N2144 BB</b>	2CLA214400N1201	5
Total Anthracite	<b>N2144 AA</b>	2CLA214400N1601	5



#### Push-button blind control 2-gangs - 2M

Rated voltage: 110 - 250 Vac.  
Rated current: 16A.  
Direct control.  
Interlocked gangs.

White	<b>N2244 BL</b>	2CLA224400N1101	5
Silver	<b>N2244 PL</b>	2CLA224400N1301	5
Anthracite	<b>N2244 AN</b>	2CLA224400N1801	5
Champagne	<b>N2244 CV</b>	2CLA224400N1901	5



#### Switch blind control 1-gang - 1M

Rated voltage: 110 - 250 Vac.  
Rated current: 10(3)A.  
Direct control.

White	<b>N2144.1 BL</b>	2CLA214410N1101	5
Silver	<b>N2144.1 PL</b>	2CLA214410N1301	5
Anthracite	<b>N2144.1 AN</b>	2CLA214410N1801	5
Champagne	<b>N2144.1 CV</b>	2CLA214410N1901	5
Total White	<b>N2144.1 BB</b>	2CLA214410N1201	5
Total Anthracite	<b>N2144.1 AA</b>	2CLA214410N1601	5



#### Switch blind control 2-gangs - 2M

Rated voltage: 110 - 250 Vac.  
Rated current: 16 AX.  
Rated power iLED (230/127 Vac): 200/100 W.  
Direct control.  
Interlocked gangs.

White	<b>N2244.1 BL</b>	2CLA224410N1101	5
Anthracite	<b>N2244.1 AN</b>	2CLA224410N1301	5
Silver	<b>N2244.1 PL</b>	2CLA224410N1801	5
Champagne	<b>N2244.1 CV</b>	2CLA224410N1901	5

Color	Article-No.	Order-No.	Pack/Qty
-------	-------------	-----------	----------



#### Electronic blind control 1-gang - 2M

Rated voltage: 110 - 250 Vac; 50/60 Hz.  
Rated current: 700VA@230Vac / 350VA@127Vac.  
Direct control.  
Green locator LED included.

Functions:

- PERS: standard blinds control. Optionally other N2244 inserts can be connected to the N2261.2 to control the blind from other locations.
- LAM: venetian type blinds control. Optionally other N2244 inserts can be connected to the N2261.2 to control the blind from other locations.
- Centralization (CEN): one N2261.2 can control all the N2261.2 centrally.

White	<b>N2261.2 BL</b>	2CLA226120N1101	1
Silver	<b>N2261.2 PL</b>	2CLA226120N1301	1
Anthracite	<b>N2261.2 AN</b>	2CLA226120N1801	1
Champagne	<b>N2261.2 CV</b>	2CLA226120N1901	1



#### Electronic blind control 1-gang - 2M

Rated voltage: 110 - 250 Vac; 50/60 Hz.  
Rated current: 700VA@230Vac / 350VA@127Vac.  
Direct control.  
White locator LED included.

Functions:

- PERS: standard blinds control. Optionally other N2244 inserts can be connected to the N2261.2 to control the blind from other locations.
- LAM: venetian type blinds control. Optionally other N2244 inserts can be connected to the N2261.2 to control the blind from other locations.
- Centralization (CEN): one N2261.2 can control all the N2261.2 centrally.





White-W	<b>N2261.21 BL</b>	2CLA226121N1201	1
Silver-W	<b>N2261.21 PL</b>	2CLA226121N1101	1
Anthracite-W	<b>N2261.21 AN</b>	2CLA226121N1601	1
Champagne-W	<b>N2261.21 CV</b>	2CLA226121N1901	1

## Zenit

### Locator & indicator lights

Color	Article-No.	Order-No.	Pack/Qty
 <p><b>Locator LED lamp kit - Card switch</b> Suitable for N2214.1 card switches. LED lamp. N2193 NG &amp; N2193 BB: 230Vac / 0,7mA N2193 VD: 127Vac / 0,7mA Toolless front connection.</p>			
Green	<b>N2193 NG</b>	2CLA219310N1001	20
Green	<b>N2193 VD</b>	2CLA219300N1001	20
White	<b>N2193 BB</b>	2CLA219300N1201	20
 <p><b>Locator lamp kit - 1-way SP switches and push-buttons</b> Suitable for 1-way SP switches and SP NO push-buttons. LED lamp. N2191 VD &amp; N2191 BB: 230Vac / 0,2mA N2191 BL: 127Vac / 0,2mA Toolless front connection. Includes diffusers for 1 and 2 module rocker covers. Rated current: &lt;0,2 mA. Specially designed for CFL and LED lamps.</p>			
Green	<b>N2191 VD</b>	2CLA219100N1001	10
Green	<b>N2191 BL</b>	2CLA219110N1001	10
White	<b>N2191 BB</b>	2CLA219100N1201	10
 <p><b>Locator lamp kit - DP, 2-way and intermediate switches</b> Suitable for 1-way DP switches, 2-way SP switches and intermediate switches. LED lamp. N2192 RJ &amp; N2192 BB: 230Vac / 0,2mA N2192 NG: 127Vac / 0,2mA N2192.2 BB: 24V / 2mA Toolless front connection. Includes diffusers for 1 and 2 module rocker covers. Rated current: &lt;0,2 mA. Specially designed for CFL and LED lamps.</p>			
Green	<b>N2192 RJ</b>	2CLA219200N1001	10
Green	<b>N2192 NG</b>	2CLA219210N1001	10
White	<b>N2192 BB</b>	2CLA219200N1201	10
White	<b>N2192.2 BB</b>	2CLA219220N1201	10

### Decorative trims for rocker covers

Color	Article-No.	Order-No.	Pack/Qty
 <p><b>Decorative trim - 1M</b> Spare decorative trim. Suitable for N2101.X, N2102.X, N2110 and N2104.X inserts.</p>			
Green diffuser	<b>N2170 VD</b>	2CLA217000N1001	20
White diffuser	<b>N2170 TL</b>	2CLA217000N1201	20
White	<b>N2170 BL</b>	2CLA217000N1101	20
Anthracite	<b>N2170 AN</b>	2CLA217000N1401	20
Chrome	<b>N2170 CR</b>	2CLA217000N1801	20
Champagne	<b>N2170 CV</b>	2CLA217000N1901	20
 <p><b>Decorative trim - 1,5M</b> Spare decorative trim. Suitable for N2801, N2802 and N2810 inserts.</p>			
White	<b>N2870 BL</b>	2CLA287000N1101	20
Anthracite	<b>N2870 AN</b>	2CLA287000N1801	20
Champagne	<b>N2870 CV</b>	2CLA287000N1901	20
 <p><b>Decorative trim - 2M</b> Spare decorative trim. Suitable for N2201.X, N2202.X, N2210 and N2204.X inserts.</p>			
Green diffuser	<b>N2270 VD</b>	2CLA227000N1001	20
White diffuser	<b>N2270 TL</b>	2CLA227000N1201	20
White	<b>N2270 BL</b>	2CLA227000N1101	20
Chrome	<b>N2270 CR</b>	2CLA227000N1401	20
Anthracite	<b>N2270 AN</b>	2CLA227000N1801	20
Champagne	<b>N2270 CV</b>	2CLA227000N1901	20
 <p><b>Decorative trim - 3M</b> Spare decorative trim. Suitable for N2301, N2302, N2310 and N2304 inserts.</p>			
White	<b>N2370 BL</b>	2CLA237000N1101	20
Anthracite	<b>N2370 AN</b>	2CLA237000N1801	20
Champagne	<b>N2370 CV</b>	2CLA237000N1901	20

## Zenit

### Socket outlets

Color	Article-No.	Order-No.	Pack/Qty
 <p><b>Schuko socket outlet - 2M</b> Rated voltage: 250 Vac. Rated current: 16A. Type F: 2P + E. Shuttered for child safety. Screw terminals.</p>			
White	<b>N2288 BL</b>	2CLA228800N1101	10
Silver	<b>N2288 PL</b>	2CLA228800N1301	10
Anthracite	<b>N2288 AN</b>	2CLA228800N1801	10
Champagne	<b>N2288 CV</b>	2CLA228800N1901	10

 <p><b>Schuko socket outlet - 2M</b> Rated voltage: 250 Vac. Rated current: 16A. Type F: 2P + E. Shuttered for child safety. Screw terminals. Suitable to identify special circuits.</p>			
Red	<b>N2288 RJ</b>	2CLA228800N7001	5
Green	<b>N2288 VD</b>	2CLA228800N8001	5
Orange	<b>N2288 NA</b>	2CLA228800N9001	5

 <p><b>Schuko socket outlet with lid - 2M</b> Rated voltage: 250 Vac. Rated current: 16A. Type F: 2P + E. Shuttered for child safety. Screw terminals. Lid with notch. 180° opening.</p>			
White	<b>N2288.1 BL</b>	2CLA228810N1101	10
Silver	<b>N2288.1 PL</b>	2CLA228810N1301	10
Anthracite	<b>N2288.1 AN</b>	2CLA228810N1801	10
Champagne	<b>N2288.1 CV</b>	2CLA228810N1901	10

 <p><b>Schuko socket outlet screwless terminal - 2M</b> Rated voltage: 250 Vac. Rated current: 16A. Type F: 2P + E. Shuttered for child safety. Screwless terminals.</p>			
White	<b>N2288.6 BL</b>	2CLA228860N1101	10
Silver	<b>N2288.6 PL</b>	2CLA228860N1301	10
Anthracite	<b>N2288.6 AN</b>	2CLA228860N1801	10
Champagne	<b>N2288.6 CV</b>	2CLA228860N1901	10

 <p><b>European unearthed socket outlet - 2M</b> Rated voltage: 250 Vac. Rated current: 16A. Type C: 2P (non earthed). Shuttered for child safety. Screw terminals.</p>			
White	<b>N2203 BL</b>	2CLA220300N1101	10
Silver	<b>N2203 PL</b>	2CLA220300N1301	10
Anthracite	<b>N2203 AN</b>	2CLA220300N1801	10
Champagne	<b>N2203 CV</b>	2CLA220300N1901	10

Color	Article-No.	Order-No.	Pack/Qty
 <p><b>French/Earth-pin socket outlet - 2M</b> Rated voltage: 250 Vac. Rated current: 16A. Type E: 2P + E. Shuttered for child safety. Screw terminals.</p>			
White	<b>N2287 BL</b>	2CLA228700N1101	10
Silver	<b>N2287 PL</b>	2CLA228700N1301	10
Anthracite	<b>N2287 AN</b>	2CLA228700N1801	10
Champagne	<b>N2287 CV</b>	2CLA228700N1901	10

 <p><b>French/Earth-pin socket outlet - 2M</b> Rated voltage: 250 Vac. Rated current: 16A. Type E: 2P + E. Shuttered for child safety. Screw terminals. Suitable to identify special circuits.</p>			
Red	<b>N2287 RJ</b>	2CLA228770N1001	10

 <p><b>French/Earth-pin socket outlet screwless - 2M</b> Rated voltage: 250 Vac. Rated current: 16A. Type E: 2P + E. Shuttered for child safety. Screwless terminals.</p>			
White	<b>N2287.6 BL</b>	2CLA228760N1101	10
Silver	<b>N2287.6 PL</b>	2CLA228760N1301	10
Anthracite	<b>N2287.6 AN</b>	2CLA228760N1801	10
Champagne	<b>N2287.6 CV</b>	2CLA228760N1901	10

 <p><b>French/Earth-pin socket outlet screwless - 2M</b> Rated voltage: 250 Vac. Rated current: 16A. Type E: 2P + E. Shuttered for child safety. Screwless terminals. Suitable to identify special circuits.</p>			
Red	<b>N2287.6 RJ</b>	2CLA228760N7001	10
Green	<b>N2287.6 VD</b>	2CLA228760N8001	10

 <p><b>Italian / German socket outlet - 2M</b> Rated voltage: 250 Vac. Rated current: 10 / 16A. Type F+L: 2P + E / P30/17. Shuttered for child safety. Screw terminals.</p>			
White	<b>N2233 BL</b>	2CLA223300N1101	10
Silver	<b>N2233 PL</b>	2CLA223300N1301	10
Anthracite	<b>N2233 AN</b>	2CLA223300N1801	10
Champagne	<b>N2233 CV</b>	2CLA223300N1901	10
Red	<b>N2233 RJ</b>	2CLA223300N7001	10

## Zenit

## Socket outlets

Color	Article-No.	Order-No.	Pack/Qty
 <p><b>Italian 10/16A socket outlet - 1M</b>            Rated voltage: 250 Vac.            Rated current: 10 / 16A.            Type L: 2P + E / P17/11.            Shuttered for child safety.            Screw terminals.</p>			
White	<b>N2133 BL</b>	2CLA213300N1101	20
Silver	<b>N2133 PL</b>	2CLA213300N1301	20
Anthracite	<b>N2133 AN</b>	2CLA213300N1801	20
Champagne	<b>N2133 CV</b>	2CLA213300N1901	20
Red	<b>N2133 RJ</b>	2CLA213300N7001	20

 <p><b>Italian 10A socket outlet - 1M</b>            Rated voltage: 250 Vac.            Rated current: 10A.            Type L: 2P + E / P11.            Shuttered for child safety.            Screw terminals.</p>			
White	<b>N2133.1 BL</b>	2CLA213310N1101	20
Silver	<b>N2133.1 PL</b>	2CLA213310N1301	20
Anthracite	<b>N2133.1 AN</b>	2CLA213310N1801	20
Champagne	<b>N2133.1 CV</b>	2CLA213310N1901	20
Red	<b>N2133.1 RJ</b>	2CLA213310N7001	20

 <p><b>American earthed socket outlet - 1M</b>            Rated voltage: 125 Vac.            Rated current: 15A.            Type B: 2P + E / NEMA 5-15R.            Shuttered for child safety.            Screw terminals.</p>			
White	<b>N2128 BL</b>	2CLA212800N1101	20
Silver	<b>N2128 PL</b>	2CLA212800N1301	20
Anthracite	<b>N2128 AN</b>	2CLA212800N1801	20
Champagne	<b>N2128 CV</b>	2CLA212800N1901	20

 <p><b>American earthed duplex socket outlet - 3M</b>            Rated voltage: 125 Vac.            Rated current: 15A.            Type B: 2P + E / NEMA 5-15R.            Duplex outlet.            Shuttered for child safety.            Screw terminals.</p>			
White	<b>N2328 BL</b>	2CLA232800N1101	20
Silver	<b>N2328 PL</b>	2CLA232800N1301	20
Anthracite	<b>N2328 AN</b>	2CLA232800N1801	20
Champagne	<b>N2328 CV</b>	2CLA232800N1901	20

 <p><b>Euro-American unearthed socket outlet - 1M</b>            Rated voltage: 125 / 250 Vac.            Rated current: 15 / 16A.            Type A+C: 2P / NEMA 1-15R (non-earthed).            Screw terminals.</p>			
White	<b>N2135 BL</b>	2CLA213501N1101	20
Silver	<b>N2135 PL</b>	2CLA213501N1301	20
Anthracite	<b>N2135 AN</b>	2CLA213501N1801	20
Champagne	<b>N2135 CV</b>	2CLA213501N1901	20

Color	Article-No.	Order-No.	Pack/Qty
 <p><b>Euro-American earthed socket outlet - 1M</b>            Rated voltage: 125 / 250 Vac.            Rated current: 15 / 16 A.            Type B+C: 2P / NEMA 5-15R.            Shuttered for child safety.            Screw terminals.</p>			
White	<b>N2138 BL</b>	2CLA213800N1101	20
Silver	<b>N2138 PL</b>	2CLA213800N1301	20
Anthracite	<b>N2138 AN</b>	2CLA213800N1801	20
Champagne	<b>N2138 CV</b>	2CLA213800N1901	20

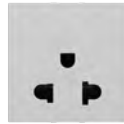
 <p><b>Euro-American earthed socket outlet - 2M</b>            Rated voltage: 125 / 250 Vac.            Rated current: 15 / 16A.            Type B+C: 2P / NEMA 5-15R.            Shuttered for child safety.            Screw terminals.</p>			
White	<b>N2238 BL</b>	2CLA223801N1101	10
Silver	<b>N2238 PL</b>	2CLA223801N1301	10
Anthracite	<b>N2238 AN</b>	2CLA223801N1801	10
Champagne	<b>N2238 CV</b>	2CLA223801N1901	10

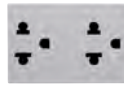



 <p><b>Euro-American duplex socket outlet - 3M</b>            Rated voltage: 125 / 250 Vac.            Rated current: 15 / 16A.            Type B+C: 2P / NEMA 5-15R.            Duplex outlet.            Shuttered for child safety.            Screw terminals</p>			
White	<b>N2338 BL</b>	2CLA233800N1101	20
Silver	<b>N2338 PL</b>	2CLA233800N1301	20
Anthracite	<b>N2338 AN</b>	2CLA233800N1801	20
Champagne	<b>N2338 CV</b>	2CLA233800N1901	20

 <p><b>Brazilian 10A socket outlet - 1M</b>            Rated voltage: 250 Vac.            Rated current: 10 A.            Type N: 2P + E.            Shuttered for child safety.            Screw terminals.</p>			
White	<b>N2136 BL</b>	2CLA213600N1101	20
Silver	<b>N2136 PL</b>	2CLA213600N1301	20
Anthracite	<b>N2136 AN</b>	2CLA213600N1801	20
Champagne	<b>N2136 CV</b>	2CLA213600N1901	20



 <p><b>Brazilian 10A socket outlet - 1M</b>            Rated voltage: 250 Vac.            Rated current: 10 A.            Type N: 2P + E.            Shuttered for child safety.            Screw terminals.            Suitable to identify special circuits.</p>			
Red	<b>N2136 RJ</b>	2CLA213600N7001	20

## Zenit

### Socket outlets

Color	Article-No.	Order-No.	Pack/Qty
 <p><b>Brazilian 20A socket outlet - 1M</b>            Rated voltage: 250 Vac.            Rated current: 20 A.            Type N: 2P + E.            Shuttered for child safety.            Screw terminals.</p>			
White	<b>N2136.2 BL</b>	2CLA213620N1101	20
Silver	<b>N2136.2 PL</b>	2CLA213620N1301	20
Anthracite	<b>N2136.2 AN</b>	2CLA213620N1801	20
Champagne	<b>N2136.2 CV</b>	2CLA213620N1901	20
 <p><b>Brazilian 20A socket outlet - 1M</b>            Rated voltage: 250 Vac.            Rated current: 20 A.            Type N: 2P + E.            Shuttered for child safety.            Screw terminals.            Suitable to identify special circuits.</p>			
Red	<b>N2136.2 RJ</b>	2CLA213620N7001	20
 <p><b>British type socket outlet - 2M</b>            Rated voltage: 250 Vac.            Rated current: 13A.            Type G: 2P + E.            Without switch.            Shuttered for child safety.            Screw terminals.</p>			
White	<b>N2237 BL</b>	2CLA223700N1101	10
Silver	<b>N2237 PL</b>	2CLA223700N1301	10
Anthracite	<b>N2237 AN</b>	2CLA223700N1801	10
Champagne	<b>N2237 CV</b>	2CLA223700N1901	10
 <p><b>Universal socket outlet - 2M</b>            Rated voltage: 125 / 250 Vac.            Rated current: 13 / 16A.            Multiple type: 2P + E.            Shuttered for child safety.            Screw terminals.</p>			
White	<b>N2239 BL</b>	2CLA223900N1101	10
Silver	<b>N2239 PL</b>	2CLA223900N1301	10
Anthracite	<b>N2239 AN</b>	2CLA223900N1801	10
Champagne	<b>N2239 CV</b>	2CLA223900N1901	10

### USB Charger

Color	Article-No.	Order-No.	Pack/Qty
 <p><b>USB charger type-A 750mA, 1-gang - 1M</b>            Input voltage: 100 - 240 Vac <math>\pm 10\%</math>; 50/60 Hz.            Input current: 0,12 A (with maximum load).            Output voltage: 5 Vdc <math>\pm 5\%</math>.            Output current: 750 mA.            Power consumption in stand-by: <math>\leq 0,3W@230Vac</math>.            Energy efficiency: <math>\geq 66\%</math>.            Operating temperature: 0 °C to 45 °C.</p>			
White	<b>N2185 BL</b>	2CLA218500N1101	1
Silver	<b>N2185 PL</b>	2CLA218500N1301	1
Anthracite	<b>N2185 AN</b>	2CLA218500N1801	1
Champagne	<b>N2185 CV</b>	2CLA218500N1901	1
 <p><b>USB charger type-A 2.000mA, 1-gang - 1M</b>            Input voltage: 100 - 230 Vac <math>\pm 10\%</math>; 50/60 Hz.            Input current: 0,20 A (with maximum load).            Output voltage: 5 Vdc <math>\pm 5\%</math>.            Output current: 2.000 mA.            Power consumption in stand-by: <math>\leq 0,01W@230Vac</math>.            Energy efficiency: <math>\geq 79\%</math>.            Operating temperature: 0 °C to 45 °C.</p>			
White	<b>N2185.2 BL</b>	2CLA218520N1101	1
Silver	<b>N2185.2 PL</b>	2CLA218520N1301	1
Anthracite	<b>N2185.2 AN</b>	2CLA218520N1801	1
Champagne	<b>N2185.2 CV</b>	2CLA218520N1901	1
 <p><b>USB charger type-A 1.500mA, 2-gang - 2M</b>            Input voltage: 100 - 240 Vac <math>\pm 10\%</math>; 50/60 Hz.            Input current: 0,20 A (with maximum load).            Output voltage: 5 Vdc <math>\pm 5\%</math>.            Output current: 1.500 mA (total for both gangs).            Power consumption in stand-by: <math>\leq 0,3W@230Vac</math>.            Energy efficiency: <math>\geq 71\%</math>.            Operating temperature: 0 °C to 35 °C.</p>			
White	<b>N2285 BL</b>	2CLA228500N1101	1
Silver	<b>N2285 PL</b>	2CLA228500N1301	1
Anthracite	<b>N2285 AN</b>	2CLA228500N1801	1
Champagne	<b>N2285 CV</b>	2CLA228500N1901	1

## Zenit

## Protection devices

Color	Article-No.	Order-No.	Pack/Qty
 <p><b>Fuse holder - 1M</b>            Rated voltage: 250 Vac.            Rated current: 16A.            Fuse type / dimension: glass tube / 6 x 24 mm.</p>			
White	<b>N2108 BL</b>	2CLA210800N1101	20
Silver	<b>N2108 PL</b>	2CLA210800N1301	20
Anthracite	<b>N2108 AN</b>	2CLA210800N1801	20
Champagne	<b>N2108 CV</b>	2CLA210800N1901	20

 <p><b>Fuse holder - 2M</b>            Rated voltage: 250 Vac.            Rated current: 16A.            Fuse type / dimension: glass tube / 6 x 24 mm.</p>			
White	<b>N2208 BL</b>	2CLA220800N1101	10
Silver	<b>N2208 PL</b>	2CLA220800N1301	10
Anthracite	<b>N2208 AN</b>	2CLA220800N1801	10
Champagne	<b>N2208 CV</b>	2CLA220800N1901	10



Color	Article-No.	Order-No.	Pack/Qty
 <p><b>Circuit breaker 6A &amp; RCD - 2M</b>            Rated voltage: 120 - 230 Vac; 50/60 Hz.            Rated current: 6A.            Braking capacity: 1.500A.            Residual current (sensitivity - I<math>\Delta</math>n): 10 mA.            C type magneto-thermic protection.            A type residual current protection.            Two-pole (1P + N) with 1 protected pole.</p>			
White	<b>N2234.1 BL</b>	2CLA223410N1101	1
Silver	<b>N2234.1 PL</b>	2CLA223410N1301	1
Anthracite	<b>N2234.1 AN</b>	2CLA223410N1801	1
Champagne	<b>N2234.1 CV</b>	2CLA223410N1901	1



 <p><b>Circuit breaker 10A &amp; RCD - 2M</b>            Rated voltage: 120 - 230 Vac; 50/60 Hz.            Rated current: 10A.            Braking capacity: 3.000A.            Residual current (sensitivity - I<math>\Delta</math>n): 10 mA.            C type magneto-thermic protection.            A type residual current protection.            Two-pole (1P + N) with 1 protected pole.</p>			
White	<b>N2234.2 BL</b>	2CLA223420N1101	1
Silver	<b>N2234.2 PL</b>	2CLA223420N1301	1
Anthracite	<b>N2234.2 AN</b>	2CLA223420N1801	1
Champagne	<b>N2234.2 CV</b>	2CLA223420N1901	1

 <p><b>Circuit breaker 16A &amp; RCD - 2M</b>            Rated voltage: 120 - 230 Vac; 50/60 Hz.            Rated current: 16A.            Braking capacity: 3.000A.            Residual current (sensitivity - I<math>\Delta</math>n): 10 mA.            C type magneto-thermic protection.            A type residual current protection.            Two-pole (1P + N) with 1 protected pole.</p>			
White	<b>N2234.3 BL</b>	2CLA223430N1101	1
Silver	<b>N2234.3 PL</b>	2CLA223430N1301	1
Anthracite	<b>N2234.3 AN</b>	2CLA223430N1801	1
Champagne	<b>N2234.3 CV</b>	2CLA223430N1901	1

## Zenit

### TV socket outlets

Product	Article-No.	Order-No.	Pack/Qty
 <p><b>TV / R terminal outlet</b> TV and R double outlet - Final. Without filter. Installation as a terminal outlet connected to a tap-off or splitter (without terminal resistor). Connection: screw terminal and clamp. Output connectors (C1 / C2): IEC male 9,52 mm. diam. / IEC female 9,52 mm. diam. Frequency range (I/O / C1 / C2): 5 - 862 MHz / 5 - 862 MHz / 5 - 862 MHz. Basic loss (FM / DAB / VHF / UHF): 10,0±0,7 dB / 10,0 ±1,5 dB / 4,0±1,5 dB / 3,0±0,5 dB. Isolation (FM / TV): &gt;14 / &gt;14. Return loss (FM / TV): &gt;18 / &gt;10. To be installed with N2250.8 cover plates. Fitting boxes with 60mm distance between screws (codes: 1099, 1999 and 1999.2).</p>	<b>8150</b>	2CLA815000A1001	10
 <p><b>TV / R final outlet - CATV outlet</b> TV and R double outlet - CATV outlet - Final. With filter. Installation as a terminal outlet connected to a tap-off or splitter (without terminal resistor). Connection: screw terminal and clamp. Output connectors (C1 / C2): IEC male 9,52 mm. diam. / IEC female 9,52 mm. diam. Frequency range (C1 / C2): 5 - 68 &amp; 118 - 1.000 MHz / 87,5 - 108 MHz. Basic loss (R / FM / TV): 0,3±0,1 dB / 1,1 ±0,3 dB / 0,9±0,3 dB. Isolation (FM / TV): &gt;18 / &gt;16. Selectivity (FM / TV): &gt;10 / &gt;18. Return loss (R / FM / TV): &gt;18 / &gt;16 / &gt;18. Chroma-luminance delay (ns): &lt;10. To be installed with N2250.8 cover plates. Fitting boxes with 60mm distance between screws (codes: 1099, 1999 and 1999.2).</p>	<b>8150.3</b>	2CLA815030A1001	10
 <p><b>TV / R loop-through outlet</b> TV and R double outlet - Intermediate. Installation as an intermediate outlet in series connected to each other. From 2nd to 4th floor. Connection: screw terminal and clamp. Output connectors (C1 / C2): IEC male 9,52 mm. diam. / IEC female 9,52 mm. diam. Frequency range (I/O / C1 / C2): 13 - 862 MHz / 13 - 862 MHz / 13 - 862 MHz. Basic loss (FM / DAB / VHF / UHF): 25±1,5 dB / 25 ±1,5 dB / 8,0±0,7 dB / 8,0±0,7 dB. Through loss (FM / VHF / UHF): 2,0±0,3 dB / 2,0±0,5 dB / 2,0±0,5 dB. Directivity (FM / TV): &gt;12 dB / &gt;9 dB. Isolation (FM / TV): &gt;16 / &gt;15. Return loss (FM / TV): &gt;12 / &gt;12. To be installed with N2250.8 cover plates. Fitting boxes with 60mm distance between screws (codes: 1099, 1999 and 1999.2).</p>	<b>8150.7</b>	2CLA815070A1001	10

Color	Article-No.	Order-No.	Pack/Qty
 <p><b>Cover plate for TV/R outlet - 2M</b> Cover plates for outlets with 2 connectors codes 8150, 8150.3 and 8150.7. Covers prepared to fix the frame to the wall. TV and R engraved in the front.</p>			
White	<b>N2250.8 BL</b>	2CLA225080N1101	20
Silver	<b>N2250.8 PL</b>	2CLA225080N1301	20
Anthracite	<b>N2250.8 AN</b>	2CLA225080N1801	20
Champagne	<b>N2250.8 CV</b>	2CLA225080N1901	20
 <p><b>TV-R/SAT terminal outlet</b> TV-R and SAT double outlet - Final. Installation as a terminal outlet connected to a tap-off or splitter (without terminal resistor). Connection: screw terminal and clamp. Output connectors (C1 / C2): IEC male 9,52 mm. diam. / IEC female 9,52 mm. diam. Frequency range (I/O / C1 / C2): 5 - 2.400 MHz / 5 - 862 MHz / 930 - 2.400 MHz. Basic loss (FM / TV / SAT): 0,2±0,1 dB / 1,0 ±0,5 dB / 1,2±0,6 dB. Isolation (FM / TV / SAT): &gt;45 / &gt;14 / &gt;14. Selectivity (TV-R / SAT): &gt;15 / &gt;15. Return loss (VR / FM / TV / SAT): &gt;25 / &gt;25 / &gt;14 / &gt;10. DC path (Vdc / mA / Tono): 24 max. / 500 max. / 22 KHz - DiSeqC. To be installed with N2250.1 cover plates. Fitting boxes with 60mm distance between screws (codes: 1099, 1999 and 1999.2).</p>	<b>8151.3</b>	2CLA815130A1001	10
 <p><b>TV-R/SAT final outlet</b> TV-R and SAT double outlet - Final. Installation as a terminal outlet connected to a series with loop-through outlets. Connection: screw terminal and clamp. Output connectors (C1 / C2): IEC male 9,52 mm. diam. / IEC female 9,52 mm. diam. Frequency range (I/O / C1 / C2): 5 - 2.400 MHz / 5 - 2.400 MHz / 5 - 2.400 MHz. Basic loss (FM / TV / SAT): 3,7±0,3 dB / 4,0±0,5 dB / 5,0±1,2 dB. Isolation (FM / TV / SAT): &gt;20 / &gt;20 / &gt;14. Return loss (VR / FM / TV / SAT): &gt;16 / &gt;16 / &gt;16 / &gt;9. DC path (Vdc / mA / Tono): 24 max. / 500 max. / 22 KHz - DiSeqC. To be installed with N2250.1 cover plates. Fitting boxes with 60mm distance between screws (codes: 1099, 1999 and 1999.2).</p>	<b>8151.7</b>	2CLA815170A1001	10



## Zenit

## TV socket outlets

Product	Article-No.	Order-No.	Pack/Qty
 <p><b>TV-R/SAT loop-through outlet</b> TV-R and SAT double outlet - Intermediate. Installation as an intermediate outlet in series connected to each other. Output connectors (C1 / C2): IEC male 9,52 mm. diam. / IEC female 9,52 mm. diam. Frequency range (I/O / C1 / C2): 5 - 2.400 MHz / 5 - 2.400 MHz / 5 - 2.400 MHz. Basic loss (FM / TV / SAT): 10,0±1,0 dB / 10,0±1,0 dB / 12,0±2,0 dB. Through loss (FM / TV / SAT): 2,5±0,5 / 2,5±0,7 / 3,0±1,0. Directivity (FM / TV / SAT): &gt;20 / &gt;12 / &gt;5. Isolation (FM / TV / SAT): &gt;45 / &gt;30 / &gt;28. Return loss (VR / FM / TV / SAT): &gt;13 / &gt;13 / &gt;12 / &gt;12. DC path (Vdc / mA / Tono): 24 max. / 500 max. / 22 KHz - DiSeqC. To be installed with N2250.1 cover plates. Fitting boxes with 60mm distance between screws (codes: 1099, 1999 and 1999.2).</p>	<b>8151.8</b>	2CLA815180A1001	10

Color	Article-No.	Order-No.	Pack/Qty
White	<b>N2250.1 BL</b>	2CLA225010N1101	20
Silver	<b>N2250.1 PL</b>	2CLA225010N1301	20
Anthracite	<b>N2250.1 AN</b>	2CLA225010N1801	20
Champagne	<b>N2250.1 CV</b>	2CLA225010N1901	20

Color	Article-No.	Order-No.	Pack/Qty
 <p><b>TV/R/SAT final outlet</b> TV, R and SAT triple outlet - Final. Installation as a terminal outlet. Connection: screw terminal and clamp. Output connectors (C1 / C2 / C3): IEC male 9,52 mm. diam. / IEC female 9,52 mm. diam. / F female Frequency range (I / C1 / C2 / C3): 5 - 2.500 MHz / 5 - 68 &amp; 125 - 862 MHz / 87,5 - 108 MHz / 950 - 2.5000 MHz. Basic loss (FM / TV / SAT): 2,0 dB / 2,7 dB / 2,3 dB. Isolation (FM / TV / SAT): &gt;24,3 / &gt;15 / &gt;15. Selectivity (FM / TV / SAT): &gt;15 / &gt;15 / &gt;15. Return loss (VR / FM / TV / SAT): &gt;7,6 / &gt;10 / &gt;7,6 / &gt;8,2. DC path (Vdc / mA / Tono): 34 max. / 500 max. / 22 KHz - DiSeqC. To be installed with N2252 cover plates. Fitting boxes with 60mm distance between screws (Codes: 1099, 1999 and 1999.2).</p>	<b>8152.7</b>	2CLA815270A1002	10

Color	Article-No.	Order-No.	Pack/Qty
White	<b>N2252 BL</b>	2CLA225200N1101	20
Silver	<b>N2252 PL</b>	2CLA225200N1301	20
Anthracite	<b>N2252 AN</b>	2CLA225200N1801	20
Champagne	<b>N2252 CV</b>	2CLA225200N1901	20

Color	Article-No.	Order-No.	Pack/Qty
 <p><b>TV-R/SAT terminal outlet - 2M</b> TV-R and SAT double outlet - Final. Installation as a terminal outlet connected to a tap-off or splitter (without terminal resistor). Connection: screw terminal and clamp. Output connectors (C1 / C2): IEC male 9,52mm diam. / IEC female 9,52mm diam. Frequency range (I/O / C1 / C2): 5 - 2.400 MHz / 5 - 862 MHz / 930 - 2.400 MHz. Basic loss (FM / TV / SAT): 0,2±0,1 dB / 1,0 ±0,5 dB / 1,2±0,6 dB. Isolation (FM / TV / SAT): &gt;45 / &gt;14 / &gt;14. Selectivity (TV-R / SAT): &gt;15 / &gt;15. Return loss (VR / FM / TV / SAT): &gt;25 / &gt;25 / &gt;14 / &gt;10. DC path (Vdc / mA / Tono): 24 max. / 500 max. / 22 KHz - DiSeqC.</p>	<b>N2251.3 BL</b>	2CLA225130N1101	10
	Silver	<b>N2251.3 PL</b>	2CLA225130N1301
Anthracite	<b>N2251.3 AN</b>	2CLA225130N1801	10
Champagne	<b>N2251.3 CV</b>	2CLA225130N1901	10

Color	Article-No.	Order-No.	Pack/Qty
 <p><b>TV-R/SAT final outlet - 2M</b> TV-R and SAT double outlet - Final. Installation as a terminal outlet connected to a series with loop-through outlets. Connection: screw terminal and clamp. Output connectors (C1 / C2): IEC male 9,52mm diam. / IEC female 9,52 mm. diam. Frequency range (I/O / C1 / C2): 5 - 2.400 MHz / 5 - 2.400 MHz / 5 - 2.400 MHz. Basic loss (FM / TV / SAT): 3,7±0,3 dB / 4,0±0,5 dB / 5,0±1,2 dB. Isolation (FM / TV / SAT): &gt;20 / &gt;20 / &gt;14. Return loss (VR / FM / TV / SAT): &gt;16 / &gt;16 / &gt;16 / &gt;9. DC path (Vdc / mA / Tono): 24 max. / 500 max. / 22 KHz - DiSeqC.</p>	<b>N2251.7 BL</b>	2CLA225170N1101	10
	Silver	<b>N2251.7 PL</b>	2CLA225170N1301
Anthracite	<b>N2251.7 AN</b>	2CLA225170N1801	10
Champagne	<b>N2251.7 CV</b>	2CLA225170N1901	10

Color	Article-No.	Order-No.	Pack/Qty
 <p><b>TV-R/SAT loop-through outlet - 2M</b> TV-R and SAT double outlet - Intermediate. Installation as an intermediate outlet in series connected to each other. Output connectors (C1 / C2): IEC male 9,52 mm. diam. / IEC female 9,52 mm. diam. Frequency range (I/O / C1 / C2): 5 - 2.400 MHz / 5 - 2.400 MHz / 5 - 2.400 MHz. Basic loss (FM / TV / SAT): 10,0±1,0 dB / 10,0±1,0 dB / 12,0±2,0 dB. Through loss (FM / TV / SAT): 2,5±0,5 / 2,5±0,7 / 3,0±1,0. Directivity (FM / TV / SAT): &gt;20 / &gt;12 / &gt;5. Isolation (FM / TV / SAT): &gt;45 / &gt;30 / &gt;28. Return loss (VR / FM / TV / SAT): &gt;13 / &gt;13 / &gt;12 / &gt;12. DC path (Vdc / mA / Tono): 24 max. / 500 max. / 22 KHz - DiSeqC.</p>	<b>N2251.8 BL</b>	2CLA225180N1101	10
	Silver	<b>N2251.8 PL</b>	2CLA225180N1301
Anthracite	<b>N2251.8 AN</b>	2CLA225180N1801	10
Champagne	<b>N2251.8 CV</b>	2CLA225180N1901	10

## Zenit

### TV socket outlets

Color	Article-No.	Order-No.	Pack/Qty
-------	-------------	-----------	----------



#### TV terminal outlet F-type - 1M

Single TV outlet.  
F type - female.  
For 75 Ω impedance coaxial cable.  
Frequency range: 0 - 2.000 Mhz.  
Working voltage: 250 VRMS max.  
Dielectric withstanding voltage: 500 VRMS min.

White	<b>N2150 BL</b>	2CLA215000N1101	10
Silver	<b>N2150 PL</b>	2CLA215000N1301	10
Anthracite	<b>N2150 AN</b>	2CLA215000N1801	10
Champagne	<b>N2150 CV</b>	2CLA215000N1901	10



#### TV terminal outlet M-type - 1M

Single TV outlet - Dead-end.  
M type - 9,52 mm. male.  
For 75 Ω impedance coaxial cable.  
Frequency range: 5 - 862 Mhz.  
Output loss: 0,5 dB.

White	<b>N2150.7 BL</b>	2CLA215070N1101	10
Silver	<b>N2150.7 PL</b>	2CLA215070N1301	10
Anthracite	<b>N2150.7 AN</b>	2CLA215070N1801	10
Champagne	<b>N2150.7 CV</b>	2CLA215070N1901	10



#### TV terminal outlet M-type - 2M

Single TV outlet - Dead-end.  
M type - 9,52 mm. male.  
For 75 Ω impedance coaxial cable.  
Frequency range: 5 - 862 Mhz.  
Output loss: 0,5 dB.

White	<b>N2250.7 BL</b>	2CLA225070N1101	10
Silver	<b>N2250.7 PL</b>	2CLA225070N1301	10
Anthracite	<b>N2250.7 AN</b>	2CLA225070N1801	10
Champagne	<b>N2250.7 CV</b>	2CLA225070N1901	10

Color	Article-No.	Order-No.	Pack/Qty
-------	-------------	-----------	----------



#### TV intermediate outlet M-type - 1M

Single TV outlet - Intermediate.  
M type - 9,52 mm. male.  
For 75 Ω impedance coaxial cable.  
Frequency range: 5 - 862 Mhz.  
Output loss: 11 dB.  
Through loss: 1,7 dB.

White	<b>N2150.8 BL</b>	2CLA215080N1101	10
Silver	<b>N2150.8 PL</b>	2CLA215080N1301	10
Anthracite	<b>N2150.8 AN</b>	2CLA215080N1801	10
Champagne	<b>N2150.8 CV</b>	2CLA215080N1901	10



#### TV/SAT terminal outlet - 1M

Single TV outlet - dead-end.  
- TV: M type - 9,52 mm. male.  
- SAT: F type - female.  
For 75 Ω impedance coaxial cable.  
Frequency range (TV / SAT): 5 - 862 Mhz / 950 - 2.400 MHz.  
Output loss (TV / SAT): 1 dB / 1 dB.  
DC path (Vdc / mA / Tono): 34 max. / 500 max. / 22kHz  
- DiSEqC.

White	<b>N2151.7 BL</b>	2CLA215170N1101	10
Silver	<b>N2151.7 PL</b>	2CLA215170N1301	10
Anthracite	<b>N2151.7 AN</b>	2CLA215170N1801	10
Champagne	<b>N2151.7 CV</b>	2CLA215170N1901	10



#### TV/SAT intermediate outlet - 1M

Single TV outlet - intermediate.  
- TV: M type - 9,52 mm. male.  
- SAT: F type - female.  
For 75 Ω impedance coaxial cable.  
Frequency range (TV / SAT): 5 - 862 Mhz / 950 - 2.400 MHz.  
Output loss (TV / SAT): 5 dB / 5 dB.  
Through loss (TV / SAT): 4 dB / 4 dB.  
DC path (Vdc / mA / Tono): 34 max. / 500 max. / 22kHz  
- DiSEqC.

White	<b>N2151.8 BL</b>	2CLA215180N1101	10
Silver	<b>N2151.8 PL</b>	2CLA215180N1301	10
Anthracite	<b>N2151.8 PL</b>	2CLA215180N1301	10
Champagne	<b>N2151.8 CV</b>	2CLA215180N1901	10

## Zenit

### Telephone outlets

Color	Article-No.	Order-No.	Pack/Qty
 <p><b>Telephone outlet RJ12 - 1M</b> RJ12 type connector. 6 contacts. Suitable for 2, 4 or 6 contacts jack. Screw terminals.</p>			
White	<b>N2117.6 BL</b>	2CLA211760N1101	20
Silver	<b>N2117.6 PL</b>	2CLA211760N1301	20
Anthracite	<b>N2117.6 AN</b>	2CLA211760N1801	20
Champagne	<b>N2117.6 CV</b>	2CLA211760N1901	20

 <p><b>Telephone outlet RJ12 - 2M</b> RJ12 type connector. 6 contacts. Suitable for 2, 4 or 6 contacts jack. Screw terminals.</p>			
White	<b>N2217.6 BL</b>	2CLA221760N1101	10
Silver	<b>N2217.6 PL</b>	2CLA221760N1301	10
Anthracite	<b>N2217.6 AN</b>	2CLA221760N1801	10
Champagne	<b>N2217.6 CV</b>	2CLA221760N1901	10

### Optical fiber adaptor

Color	Article-No.	Order-No.	Pack/Qty
 <p><b>Optical fiber SC simplex adapter - 1M</b> Insertion Loss (IL) <math>\leq 0.3\text{dB}</math> for SM and MM. Durability(500 Mating): 0.2dB max. increase. Withdrawal force (g/f): 100300. Operating temperature: <math>-40^{\circ}\text{C}</math> to <math>+85^{\circ}\text{C}</math>. Meet JIS C5974 and Bellcore GR-326 standard. Compliant with IEC874-14 &amp; IEC874-19. All parts compliant with ROHS.</p>			
White	<b>N2118.3 BL</b>	2CLA211830N1101	10
Silver	<b>N2118.3 PL</b>	2CLA211830N1301	10
Anthracite	<b>N2118.3 AN</b>	2CLA211830N1801	10
Champagne	<b>N2118.3 CV</b>	2CLA211830N1901	10

## Zenit

### Data outlets adapters

Color	Article-No.	Order-No.	Pack/Qty
-------	-------------	-----------	----------



**Cover plate for data outlet 1-gang - 2M**  
Cover plate for one data connector housing (refs.: 2016, 2016.1, 2016.2 and 2016.3).  
With labeling area for stickers.  
Without shutter.

White	<b>N2216.1 BL</b>	2CLA221610N1101	10
Silver	<b>N2216.1 PL</b>	2CLA221610N1301	10
Anthracite	<b>N2216.1 AN</b>	2CLA221610N1801	10
Champagne	<b>N2216.1 CV</b>	2CLA221610N1901	10



**Cover plate for data outlet 2-gang - 2M**  
Cover plate for two data connector housing (refs.: 2016, 2016.1, 2016.2 and 2016.3).  
With labeling area for stickers.  
Without shutter.

White	<b>N2216.2 BL</b>	2CLA221620N1101	10
Silver	<b>N2216.2 PL</b>	2CLA221620N1301	10
Anthracite	<b>N2216.2 AN</b>	2CLA221620N1801	10
Champagne	<b>N2216.2 CV</b>	2CLA221620N1901	10



**Cover plate for data outlet 1-gang - 2M**  
Cover plate for one data connector housing (refs.: 2016, 2016.1, 2016.2 and 2016.3).  
With labeling area for stickers.  
With shutter.

White	<b>N2216.3 BL</b>	2CLA221630N1101	10
Silver	<b>N2216.3 PL</b>	2CLA221630N1301	10
Anthracite	<b>N2216.3 AN</b>	2CLA221630N1801	10
Champagne	<b>N2216.3 CV</b>	2CLA221630N1901	10



**Cover plate for data outlet 2-gang - 2M**  
Cover plate for two data connector housing (refs.: 2016, 2016.1, 2016.2 and 2016.3).  
With labeling area for stickers.  
With shutters.

White	<b>N2216.4 BL</b>	2CLA221640N1101	10
Silver	<b>N2216.4 PL</b>	2CLA221640N1301	10
Anthracite	<b>N2216.4 AN</b>	2CLA221640N1801	10
Champagne	<b>N2216.4 CV</b>	2CLA221640N1901	10



**Cover plate for data outlet 1-gang at 45° - 2M**  
Cover plate at 45° for one data connector housing (refs.: 2016, 2016.1, 2016.2 and 2016.3).  
With labeling area for stickers.  
Without shutter.

White	<b>N2216.5 BL</b>	2CLA221650N1101	5
Silver	<b>N2216.5 PL</b>	2CLA221650N1301	5
Anthracite	<b>N2216.5 AN</b>	2CLA221650N1801	5
Champagne	<b>N2216.5 CV</b>	2CLA221650N1901	5

Color	Article-No.	Order-No.	Pack/Qty
-------	-------------	-----------	----------



**Cover plate for data outlet 2-gang at 45° - 2M**  
Cover plate at 45° for two data connector housing (refs.: 2016, 2016.1, 2016.2 and 2016.3).  
With labeling area for stickers.  
Without shutters.

White	<b>N2216.6 BL</b>	2CLA221660N1101	5
Silver	<b>N2216.6 PL</b>	2CLA221660N1301	5
Anthracite	<b>N2216.6 AN</b>	2CLA221660N1801	5
Champagne	<b>N2216.6 CV</b>	2CLA221660N1901	5



**Cover plate for data outlet 1-gang at 45° - 2M**  
Cover plate at 45° for one data connector housing (refs.: 2016, 2016.1, 2016.2 and 2016.3).  
With labeling area for stickers.  
With shutter.

White	<b>N2216.7 BL</b>	2CLA221670N1101	5
Silver	<b>N2216.7 PL</b>	2CLA221670N1301	5
Anthracite	<b>N2216.7 AN</b>	2CLA221670N1801	5
Champagne	<b>N2216.7 CV</b>	2CLA221670N1901	5



**Cover plate for data outlet 2-gang at 45° - 2M**  
Cover plate at 45° for two data connector housing (refs.: 2016, 2016.1, 2016.2 and 2016.3).  
With labeling area for stickers.  
With shutters.

White	<b>N2216.8 BL</b>	2CLA221680N1101	5
Silver	<b>N2216.8 PL</b>	2CLA221680N1301	5
Anthracite	<b>N2216.8 AN</b>	2CLA221680N1801	5
Champagne	<b>N2216.8 CV</b>	2CLA221680N1901	5





**Housing for data outlets 1-gang**  
Cover plate for two data connector housing  
Housing for RJ45 data connectors with multiple type clipping systems:  
- 2016: Keystone, 3M and AMP type.  
- 2016.1: Systimax type.  
- 2016.2: Panduit type.  
- 2016.3: R&M type.  
To be installed with 8516.8, N2216.1, N2218.2, N2216.3, N2216.4, N2216.5, N2216.6, N2216.7 and N2218.8 cover plates.

<b>2016</b>	2CLA201600A1001	10
<b>2016.1</b>	2CLA201610A1001	10
<b>2016.2</b>	2CLA201620A1001	10
<b>2016.3</b>	2CLA201630A1001	10

## Zenit

## VDI outlets

Color	Article-No.	Order-No.	Pack/Qty
 <p><b>2x RCA connection unit - 1M</b> Front: 2x RCA connectors (Red / White). Rear: screw terminals (4 wires).</p>			
White	<b>N2155.2 BL</b>	2CLA215520N1101	1
Silver	<b>N2155.2 PL</b>	2CLA215520N1301	1
Anthracite	<b>N2155.2 AN</b>	2CLA215520N1801	1
Champagne	<b>N2155.2 CV</b>	2CLA215520N1901	1

 <p><b>3x RCA connection unit - 1M</b> Front: 3x RCA connectors (Red / White / Yellow). Rear: screw terminals (6 wires).</p>			
White	<b>N2155.3 BL</b>	2CLA215530N1101	1
Silver	<b>N2155.3 PL</b>	2CLA215530N1301	1
Anthracite	<b>N2155.3 AN</b>	2CLA215530N1801	1
Champagne	<b>N2155.3 CV</b>	2CLA215530N1901	1

 <p><b>HDMI connection unit - 1M</b> Front: 1x HDMI connector (Type A connector). Rear: screwless terminals (20 wires).</p>			
White	<b>N2155.6 BL</b>	2CLA215560N1101	1
Silver	<b>N2155.6 PL</b>	2CLA215560N1301	1
Anthracite	<b>N2155.6 AN</b>	2CLA215560N1801	1
Champagne	<b>N2155.6 CV</b>	2CLA215560N1901	1

 <p><b>HDMI female-female connection unit - 1M</b> Front: 1x HDMI connector (Type A connector). Rear: 1x HDMI connector (Type A connector) fitted at 90° angle.</p>			
White	<b>N2155.7 BL</b>	2CLA215570N1101	1
Silver	<b>N2155.7 PL</b>	2CLA215570N1301	1
Anthracite	<b>N2155.7 AN</b>	2CLA215570N1801	1
Champagne	<b>N2155.7 CV</b>	2CLA215570N1901	1

 <p><b>HDMI female-female connection unit with cable - 1M</b> Front: 1x HDMI connector (Type A connector). Rear: 1x HDMI connector (Type A connector) with 20 cm cable extension.</p>			
White	<b>N2155.71 BL</b>	2CLA215571N1101	1
Silver	<b>N2155.71 PL</b>	2CLA215571N1301	1
Anthracite	<b>N2155.71 AN</b>	2CLA215571N1801	1
Champagne	<b>N2155.71 CV</b>	2CLA215571N1901	1

Color	Article-No.	Order-No.	Pack/Qty
 <p><b>Mini-Jack connection unit - 1M</b> Front: 1x Mini-Jack connector (3,5 mm. stereo audio jack). Rear: screw terminals (3/4 wires).</p>			
White	<b>N2155.4 BL</b>	2CLA215540N1101	1
Silver	<b>N2155.4 PL</b>	2CLA215540N1301	1
Anthracite	<b>N2155.4 AN</b>	2CLA215540N1801	1
Champagne	<b>N2155.4 CV</b>	2CLA215540N1901	1

 <p><b>VGA connection unit - 1M</b> Front: 1x VGA connector (DE-15 connector). Rear: screw terminals (15 wires).</p>			
White	<b>N2155.5 BL</b>	2CLA215550N1101	1
Silver	<b>N2155.5 PL</b>	2CLA215550N1301	1
Anthracite	<b>N2155.5 AN</b>	2CLA215550N1801	1
Champagne	<b>N2155.5 CV</b>	2CLA215550N1901	1

 <p><b>USB connection unit - 1M</b> Front: 1x USB 2.0 connector (Type A connector). Rear: screwless terminals (5 wires).</p>			
White	<b>N2155.8 BL</b>	2CLA215580N1101	1
Silver	<b>N2155.8 PL</b>	2CLA215580N1301	1
Anthracite	<b>N2155.8 AN</b>	2CLA215580N1801	1
Champagne	<b>N2155.8 CV</b>	2CLA215580N1901	1

 <p><b>USB female-female connection unit - 1M</b> Front: 1x USB 2.0 connector (Type A connector). Rear: 1x USB 2.0 connector (Type A connector) fitted at 90° angle.</p>			
White	<b>N2155.9 BL</b>	2CLA215590N1101	1
Silver	<b>N2155.9 PL</b>	2CLA215590N1301	1
Anthracite	<b>N2155.9 AN</b>	2CLA215590N1801	1
Champagne	<b>N2155.9 CV</b>	2CLA215590N1901	1

 <p><b>USB female-female connection unit with cable - 1M</b> Front: 1x USB 2.0 connector (Type A connector). Rear: 1x USB 2.0 connector (Type A connector) with 20 cm cable extension.</p>			
White	<b>N2155.91 BL</b>	2CLA215591N1101	1
Silver	<b>N2155.91 PL</b>	2CLA215591N1301	1
Anthracite	<b>N2155.91 AN</b>	2CLA215591N1801	1
Champagne	<b>N2155.91 CV</b>	2CLA215591N1901	1

## Zenit

### Light controls - Rotatory dimmers

Color	Article-No.	Order-No.	Pack/Qty
	<b>LED/Universal rotatory dimmer 220V - 1M</b> Rated voltage: 230 Vac ± 10%. Frequency: 50-60 Hz. Power (min./max load): - LEDi (trailing-edge lamps), LV LEDi with transformer type C, LV halogen with transformer (type C or LC) and incandescent and halogen lamps: 4 / 250 W/VA. - LEDi (leading-edge lamps) and LV LEDi with transformer type LC: 4 / 60 W/VA.* *Max. 10 lamps. Load selection 2 or 3 wire connection. OFF position Electronic back-up fuse & overload protection. Ambient temperature: 0° C to +35° C.		
White	<b>N2160.3 BL</b>	2CLA216030N1101	1
Silver	<b>N2160.3 PL</b>	2CLA216030N1301	1
Anthracite	<b>N2160.3 AN</b>	2CLA216030N1801	1
Champagne	<b>N2160.3 CV</b>	2CLA216030N1901	1

	<b>LED/Universal rotatory dimmer 110V - 1M</b> Rated voltage: 127 Vac ± 10%. Frequency: 60 Hz. Power (min./max load): - LEDi (trailing-edge lamps), LV LEDi with transformer type C, LV halogen with transformer (type C or LC) and incandescent and halogen lamps: 4 / 125 W/VA. - LEDi (leading-edge lamps) and LV LEDi with transformer type LC: 4 / 30 W/VA.* *Max. 10 lamps. Load selection 2 or 3 wire connection. OFF position Electronic back-up fuse & overload protection. Ambient temperature: 0° C to +35° C.		
White	<b>N2160.8 BL</b>	2CLA216080N1101	1
Silver	<b>N2160.8 PL</b>	2CLA216080N1301	1
Anthracite	<b>N2160.8 AN</b>	2CLA216080N1801	1
Champagne	<b>N2160.8 CV</b>	2CLA216080N1901	1

Color	Article-No.	Order-No.	Pack/Qty
	<b>LED rotatory/push dimmer - 2M</b> Rated voltage: 230 Vac ± 10%. Frequency: 50 Hz (250 W/VA) / 60 Hz (200 W/VA). Power (min./max load): - LEDi, dimmable CFL and LV LEDi with transformer (L or LC): 2 / 100 W/VA*. - Incandescent and halogen lamps: 10 / 250 W/VA. - LV halogen w/transformer (L or LC): 10 / 250 W/VA*. *: max. 10 lamps. 2 wire connection. Optional: auxiliary on/off with 2-way switch N2X02. Indicator LED lamp included. Electronic back-up fuse & overload protection. Ambient temperature: 0° C to +35° C.		
White	<b>N2260.3 BL</b>	2CLA226030N1101	1
Silver	<b>N2260.3 PL</b>	2CLA226030N1301	1
Anthracite	<b>N2260.3 AN</b>	2CLA226030N1801	1
Champagne	<b>N2260.3 CV</b>	2CLA226030N1901	1

	<b>LED rotatory/push dimmer - 2M</b> Rated voltage: 127 Vac ± 10%. Frequency: 50 / 60 Hz (140 W/VA). Power (min./max load): - LEDi, dimmable CFL and LV LEDi with transformer (L or LC): 2 / 55 W/VA*. - Incandescent and halogen lamps: 10 / 140 W/VA. - LV halogen w/transformer (L or LC): 10 / 140 W/VA*. *: max. 10 lamps. 2 wire connection. Optional: auxiliary on/off with 2-way switch N2X02. Indicator LED lamp included. Electronic back-up fuse & overload protection. Ambient temperature: 0° C to +35° C.		
White	<b>N2260.8 BL</b>	2CLA226080N1101	1
Silver	<b>N2260.8 PL</b>	2CLA226080N1301	1
Anthracite	<b>N2260.8 AN</b>	2CLA226080N1801	1
Champagne	<b>N2260.8 CV</b>	2CLA226080N1901	1

	<b>1-10V rotary dimmer - 2M</b> Rated voltage: 127 - 230 Vac / 50 - 60 Hz Dimmable electronic ballast/driver. 1-10V control input. Max. power (max. 6 ballasts per device): 700 VA @ 230 Vac / 350 VA @ 127 Vac. Indicator LED lamp included.		
White	<b>N2260.9 BL</b>	2CLA226090N1101	1
Silver	<b>N2260.9 PL</b>	2CLA226090N1301	1
Anthracite	<b>N2260.9 AN</b>	2CLA226090N1801	1
Champagne	<b>N2260.9 CV</b>	2CLA226090N1901	1

## Zenit

### Light controls - Time delay switches

Color	Article-No.	Order-No.	Pack/Qty
 <p><b>Time delayed switch - 2M</b>            Rated voltage: 230 Vac / 50 Hz.            Power:            - Incandescent: 40 - 500 W.            - Halogen with transformer: 40 - 400 VA.            - Motors: 40 - 100 VA.            2 wire connection.            Delay setup: 10 sec. to 10 min.            Overcurrent protection: with fuse.            Indicator LED lamp included.            Operating temperature: 0° C to +40° C.</p>			
White	<b>N2262.1 BL</b>	2CLA226210N1101	1
Silver	<b>N2262.1 PL</b>	2CLA226210N1301	1
Anthracite	<b>N2262.1 AN</b>	2CLA226210N1801	1
Champagne	<b>N2262.1 CV</b>	2CLA226210N1901	1

### Light controls - Electronic switch cookie

 <p><b>Electronic switch cookie - 220Vac</b>            Rated voltage: 230 Vac / 50Hz.            Rated current: 10A. NO contact. Single pole.            Power:            - LED lamps: 400 W.            - Incandescent / Halogen lamps: 2.000 W.            - Low-voltage halogen lamps with transformer (12 V): 1.000 W.            - Fluorescent lamps: 600 W (60µF).            Zero crossing technology.            Standby and operating consumption: 0 mW.            Dimensions: 61 (46) x 32 x 19mm (without flaps)            To be controlled with N2X04.X push-buttons.</p>			
	<b>8132.2</b>	2CLA813220A1001	1

 <p><b>Electronic switch cookie - 127Vac</b>            Rated voltage: 127 Vac / 60Hz.            Rated current: 10A. NO contact. Single pole.            Power:            - LED lamps: 200 W.            - Incandescent / Halogen lamps: 1.000 W.            - Low-voltage halogen lamps with transformer (12 V): 500 W.            - Fluorescent lamps: 300 W (60µF).            Zero crossing technology.            Standby and operating consumption: 0 mW.            Dimensions: 61 (46) x 32 x 19mm (without flaps)            To be controlled with N2X04.X push-buttons.</p>			
	<b>8132.1</b>	2CLA813210A1001	1

### Light controls - Motion sensors

Color	Article-No.	Order-No.	Pack/Qty
 <p><b>110° motion sensor - 2M</b>            Rated voltage: 127 - 230 Vac ± 10% / 50 - 60 Hz            Outputs: 1 Normally Open (NO). Potential free            Max. power:            - Incandescent: 1.800W @230Vac / 1.000W @127Vac            - Halogen with electronic or ferromagnetic transformer: 750VA @230Vac / 400VA @127Vac            - Fluorescent lamps or motors: 400VA @230Vac / 200VA @127Vac            For automatic switching of devices dependent on motion and brightness.            With integrated selector switch for ON-AUTOMATIC-OFF in the front side.            Switch-off delay: 10 sec to 10 min or short-time pulse 1 sec adjustable (from the front side).            Detection range: 5 m radius            Adjustable light set point level for activation (from the front side).            Detection angle: 110 °            Mounting height: 1,2 m            Auxiliary control with N2X04.X push-buttons            Temperature range (Device): -10 °C to 40 °C</p>			
White	<b>N2241 BL</b>	2CLA224100N1101	1
Silver	<b>N2241 PL</b>	2CLA224100N1301	1
Anthracite	<b>N2241 AN</b>	2CLA224100N1801	1
Champagne	<b>N2241 CV</b>	2CLA224100N1901	1

## Zenit

### Temperature controls - RTC

Color	Article-No.	Order-No.	Pack/Qty
	<b>Rotary thermostat for underfloor heating</b> Rated voltage: 230 Vac $\pm 10\%$ / 50-60 Hz. Load power: 2.300 W. Load type: floor heating resistor. Control temperature: +5°C to +45°C (Set point). OFF state: at OFF position, the thermostat is off, so that it does not address the temperature measured by the floor temperature probe. The relay output contact is open. Temperature accuracy: 0,5° C. Hysteresis: 0,5° C. Floor temperature sensor: NTC, 10 K $\Omega$ at 25° C, -40° C. to 80° C. Double isolated cable, 4 m. length. LED light indication: Red and green. Ambient temperature: -20° C to 45° C.		
White	<b>N2240.3 BL</b>	2CLA224030N1101	1
Silver	<b>N2240.3 PL</b>	2CLA224030N1301	1
Anthracite	<b>N2240.3 AN</b>	2CLA224030N1801	1
Champagne	<b>N2240.3 CV</b>	2CLA224030N1901	1

	<b>Digital room thermostat - 2M</b> Rated voltage: 230 Vac / 50-60 Hz. Power consumption: < 1W. Operating temperature range: + 0° C to 50° C. Measurement accuracy: $\pm 2^\circ$ C ( $\pm 1^\circ$ C with calibration). Resolution: 0.1° C. Control output: Potential-free relay contacts Normally Open (NO). Maximum load: 3A cos = 0,5. Output relay operation modes: - Hysteresis: 0.5° C. - Pulse-width modulation: with a $\pm 4^\circ$ C difference with the set-point temperature, variable from 100% to 0% modulation. To be installed with N2240.5 cover plates.		
	<b>8140.5</b>	2CLA814050A1001	1

	<b>Cover plate for digital thermostat- 2M</b> Cover plate for digital room thermostat code 8140.5.		
White	<b>N2240.5 BL</b>	2CLA224050N1101	5
Silver	<b>N2240.5 PL</b>	2CLA224050N1301	5
Anthracite	<b>N2240.5 AN</b>	2CLA224050N1801	5
Champagne	<b>N2240.5 CV</b>	2CLA224050N1901	5

### Temperature controls - Chronothermostat

Color	Article-No.	Order-No.	Pack/Qty
	<b>Programmable thermostat - 3M</b> Electronic time-programmable thermostat. Day/week programming. Summer/winter function. LCD display. Output: 1x NO + 1x NC. Potential free. Max.: 8(2)A Power supply: 2x 1.5V AA type battery (LR6).		
White	<b>N2340 BL</b>	2CLA234000N1101	1
Silver	<b>N2340 PL</b>	2CLA234000N1301	1
Anthracite	<b>N2340 AN</b>	2CLA234000N1801	1
Champagne	<b>N2340 CV</b>	2CLA234000N1901	1

### Temperature controls - Fan regulators

	<b>Rotary 3-speed fan control - 2M</b> Rated voltage: 127 Vac / 60 Hz. Rated current: 1,5 A. Load type: ceiling fan. 4 control positions: - 0: Off. - I: On maximum speed. - II: On medium speed. - III: On low speed. Ambient temperature: 0° C to 40° C.		
White	<b>N2254.1 BL</b>	2CLA225410N1101	1
Silver	<b>N2254.1 PL</b>	2CLA225410N1301	1
Anthracite	<b>N2254.1 AN</b>	2CLA225410N1801	1
Champagne	<b>N2254.1 CV</b>	2CLA225410N1901	1





## Zenit

## DND / MUR systems

Color	Article-No.	Order-No.	Pack/Qty
	<b>LED DND signaling light - 1M</b> Rated voltage: 127-230 Vac / 50-60 Hz. Lamp: white LED. Luminous flux: > 2 lumen at 1 meter. Red diffuser. Do Not Disturb (DND) symbol. To be controlled with N2244.5 DND/MUR 2-gang interlocked switch.		
White	<b>N2180.4 BL</b>	2CLA218040N1101	5
Silver	<b>N2180.4 PL</b>	2CLA218040N1301	5
Anthracite	<b>N2180.4 AN</b>	2CLA218040N1801	5
Champagne	<b>N2180.4 CV</b>	2CLA218040N1901	5

	<b>LED MUR signaling light - 1M</b> Rated voltage: 127-230 Vac / 50-60 Hz. Lamp: white LED. Luminous flux: > 2 lumen at 1 meter. Green diffuser. Make Up Room (MUR) symbol. To be controlled with N2244.5 DND/MUR 2-gang interlocked switch.		
White	<b>N2180.5 BL</b>	2CLA218050N1101	5
Silver	<b>N2180.5 PL</b>	2CLA218050N1301	5
Anthracite	<b>N2180.5 AN</b>	2CLA218050N1801	5
Champagne	<b>N2180.5 CV</b>	2CLA218050N1901	5







	<b>DND/MUR 2-gang interlocked switch - 2M</b> Rated voltage: 110 - 250 Vac. Rated current: 16 AX. Rated power iLED (230/127 Vac): 200/100 W. Interlocked gangs. Gang 1: Make Up Room (MUR) green symbol. Gang 2: Do Not Disturb (DND) red symbol. To control N2180.4 & N2180.5 DND/MUR signaling lights or N2280.4 DND/MUR push-button.		
White	<b>N2244.5 BL</b>	2CLA224450N1101	5
Silver	<b>N2244.5 PL</b>	2CLA224450N1301	5
Anthracite	<b>N2244.5 AN</b>	2CLA224450N1801	5
Champagne	<b>N2244.5 CV</b>	2CLA224450N1901	5
Total White	<b>N2244.5 BB</b>	2CLA224450N1201	5
Total Anthracite	<b>N2244.5 AA</b>	2CLA224450N1601	5



Color	Article-No.	Order-No.	Pack/Qty
	<b>Bell push-button with DND/MUR LED indicator - 2M</b> Rated voltage: 110 - 250 Vac Rated current: 10A Red Do Not Disturb and green Make Up Room LED signaling included. Push-button with bell symbol. To be connected to N2244.4 or N2244.5 DND/MUR room module and N2224 or N2224.1 electronic bell or N2119 or N2219 buzzer.		
White	<b>N2280.4 BL</b>	2CLA228040N1101	5
Silver	<b>N2280.4 PL</b>	2CLA228040N1301	5
Anthracite	<b>N2280.4 AN</b>	2CLA228040N1801	5
Champagne	<b>N2280.4 CV</b>	2CLA228040N1901	5
Total White	<b>N2280.4 BB</b>	2CLA228040N1201	5
Total Anthracite	<b>N2280.4 AA</b>	2CLA228040N1601	5

	<b>DND/MUR 2-gang switch - 2M</b> Rated voltage: 110 - 250 Vac. Rated current: 16 AX. Rated power iLED (230/127 Vac): 200/100 W. Non interlocked gangs. Gang 1: Make Up Room (MUR) green symbol and indicator LED lamp. Gang 2: Do Not Disturb (DND) red symbol and indicator LED lamp. To be connected to N2280.4 corridor module.		
White	<b>N2244.4 BL</b>	2CLA224440N1101	5
Silver	<b>N2244.4 PL</b>	2CLA224440N1301	5
Anthracite	<b>N2244.4 AN</b>	2CLA224440N1801	5
Champagne	<b>N2244.4 CV</b>	2CLA224440N1901	5
Total White	<b>N2244.4 BB</b>	2CLA224440N1201	5
Total Anthracite	<b>N2244.4 AA</b>	2CLA224440N1601	5

## Zenit

### Signaling and lighting systems

Color	Article-No.	Order-No.	Pack/Qty
	<b>LED white signaling light - 1M</b> Rated voltage: 127-230 Vac / 50-60 Hz. Lamp: white LED. Luminous flux: > 2 lumen at 1 meter. White diffuser.		
White	<b>N2180 BL</b>	2CLA218000N1101	5
	<b>LED warm white signaling light - 1M</b> Rated voltage: 127-230 Vac / 50-60 Hz. Lamp: white LED. 2.700 Kelvin. Low luminous flux: < 0,5 lumen at 0,3 meter. White diffuser.		
White	<b>N2180.1 BL</b>	2CLA218010N1101	5
	<b>LED signaling light - 2M</b> Rated voltage: 127-230 Vac / 50-60 Hz. Lamp: white LED. Luminous flux: > 2 lumen at 1 meter. White diffuser.		
White	<b>N2280 BL</b>	2CLA228000N1101	1
	<b>LED DND/MUR signaling light - 2M</b> Rated voltage: 127-230 Vac / 50-60 Hz. Lamp: red/green LED. Luminous flux: > 2 lumen at 1 meter. White diffuser.		
White	<b>N2280.2 RJ/VD</b>	2CLA228020N1101	1
	<b>Beacon LED light - 2M</b> Rated voltage: 230 Vac / 50 Hz. Lamp: white LED. Luminous flux: > 2 lumen at 1 meter. White diffuser. Autonomy: 3 hours (1 hour at maximum illumination 2 hours with lower illumination). Battery: Ni-MH (estimated lifetime: 4 years).		
White	<b>N2281 BL</b>	2CLA228100N1101	1
	<b>Labels for signaling / beacon lights - 2M</b> Labels with symbols for signaling and beacon lights code: N2280, N2280.2 & N2281. Symbols: "WC men", "WC women", "No smoking", "Direction", "WC handic.", "WC", "Salida" and no symbol label.		
	<b>N2281.1</b>	2CLA228110N1001	5

Color	Article-No.	Order-No.	Pack/Qty
	<b>LED red signaling light - 1M</b> Rated voltage: 127-230 Vac / 50-60 Hz. Lamp: white LED. Luminous flux: > 2 lumen at 1 meter. Red diffuser.		
Red	<b>N2180 RJ</b>	2CLA218000N1601	5
	<b>LED red signaling light - 1M</b> Rated voltage: 127-230 Vac / 50-60 Hz. Lamp: white LED. Luminous flux: > 2 lumen at 1 meter. Green diffuser.		
Green	<b>N2180 VD</b>	2CLA218000N1801	5

## Zenit

## Buzzer / Door bell

Color	Article-No.	Order-No.	Pack/Qty
-------	-------------	-----------	----------

**Buzzer - 1M**

Rated voltage: 127-230 Vac / 50-60 Hz.  
Rated power: 8 VA.  
Adjustable tone.  
Acoustic power at 1 meter with cover plate: 75 dB.

White	<b>N2119 BL</b>	2CLA21900N1101	10
Silver	<b>N2119 PL</b>	2CLA21900N1301	10
Anthracite	<b>N2119 AN</b>	2CLA21900N1801	10
Champagne	<b>N2119 CV</b>	2CLA21900N1901	10

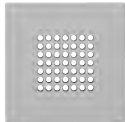
**Buzzer - 2M**

Rated voltage: 127-230 Vac / 50-60 Hz.  
Rated power: 8 VA.  
Adjustable tone.  
Acoustic power at 1 meter with cover plate: 75 dB.

White	<b>N2219 BL</b>	2CLA221900N1101	10
Silver	<b>N2219 PL</b>	2CLA221900N1301	10
Anthracite	<b>N2219 AN</b>	2CLA221900N1801	10
Champagne	<b>N2219 CV</b>	2CLA221900N1901	10

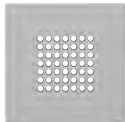
**Electronic door bell 230 Vac - 2M**

Rated voltage: 230 Vac / 50-60 Hz.  
4 melodies available.  
Acoustic power at 1 meter with cover plate: 72 dB.

White	<b>N2224 BL</b>	2CLA222400N1101	1
Silver	<b>N2224 PL</b>	2CLA222400N1301	1
Anthracite	<b>N2224 AN</b>	2CLA222400N1801	1
Champagne	<b>N2224 CV</b>	2CLA222400N1901	1

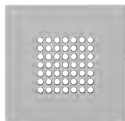
**Electronic door bell 127 Vac - 2M**

Rated voltage: 127 Vac / 60 Hz.  
4 melodies available.  
Acoustic power at 1 meter with cover plate: 72 dB.

White	<b>N2224.1 BL</b>	2CLA222410N1101	1
Silver	<b>N2224.1 PL</b>	2CLA222410N1301	1
Anthracite	<b>N2224.1 AN</b>	2CLA222410N1801	1
Champagne	<b>N2224.1 CV</b>	2CLA222410N1901	1

## Blank covers / Cable outlets

Color	Article-No.	Order-No.	Pack/Qty
-------	-------------	-----------	----------

**Blank cover plate - 0,5M**

Technical data:  
Blank cover plate for spare spaces.  
Size: 0,5 module.

White	<b>N2000 BL</b>	2CLA200000N1101	20
Silver	<b>N2000 PL</b>	2CLA200000N1301	20
Anthracite	<b>N2000 AN</b>	2CLA200000N1801	20
Champagne	<b>N2000 CV</b>	2CLA200000N1901	20

**Blank cover plate - 1M**

Blank cover plate for spare spaces.  
Size: 1 module.

White	<b>N2100 BL</b>	2CLA210000N1101	10
Silver	<b>N2100 PL</b>	2CLA210000N1301	10
Anthracite	<b>N2100 AN</b>	2CLA210000N1801	10
Champagne	<b>N2100 CV</b>	2CLA210000N1901	10

**Blank cover plate - 2M**

Blank cover plate for spare spaces.  
Size: 2 modules.

White	<b>N2200 BL</b>	2CLA220000N1101	20
Silver	<b>N2200 PL</b>	2CLA220000N1301	20
Anthracite	<b>N2200 AN</b>	2CLA220000N1801	20
Champagne	<b>N2200 CV</b>	2CLA220000N1901	20

**Cable outlet - 1M**

Maximum cable diameter: 6 mm.  
Cable tie included.

White	<b>N2107 BL</b>	2CLA210700N1101	10
Silver	<b>N2107 PL</b>	2CLA210700N1301	10
Anthracite	<b>N2107 AN</b>	2CLA210700N1801	10
Champagne	<b>N2107 CV</b>	2CLA210700N1901	10

**Cable outlet - 2M**

Maximum cable diameter: 6 mm.  
Cable tie included.

White	<b>N2207 BL</b>	2CLA220700N1101	10
Silver	<b>N2207 PL</b>	2CLA220700N1301	10
Anthracite	<b>N2207 AN</b>	2CLA220700N1801	10
Champagne	<b>N2207 CV</b>	2CLA220700N1901	10

## Zenit Float

Frames for European square and round boxes

01



**7,5 mm height.**  
Visually lightened through the 2 piece floating effect.

02



03



01 Side view, 7,5 x 85 mm (8 x 90 mm for noble materials)

1 to 5-gang cover frame suitable for horizontal and vertical installation

02 Frame 1-gang, 1 module

03 Frame 1-gang, 2 modules

04 Frame 2-gang, 2 + 2 modules

05 Frame 3-gang, 2 + 2 + 2 modules horizontal

06 Frame 3-gang, 2 + 2 + 2 modules vertical

07 Frame 4-gang, 2 + 2 + 2 + 2 modules

08 Frame 5-gang, 2 + 2 + 2 + 2 + 2 modules

04



05



06

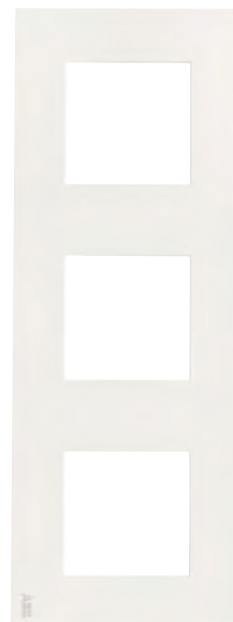

07

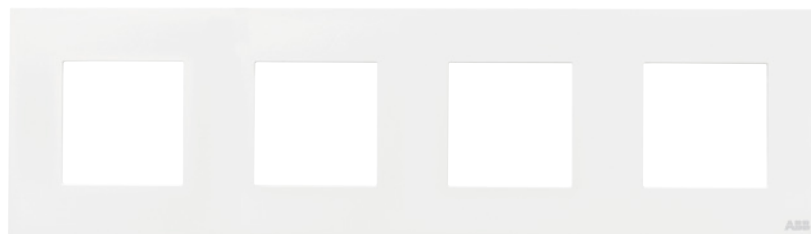

08

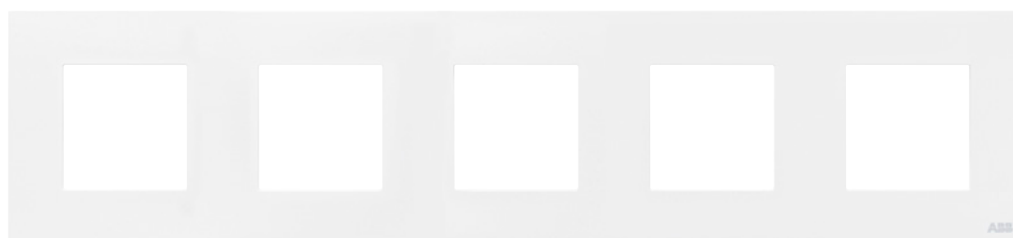

## Zenit Float

Frames for 3M (4"x2"), 4M, 7M, 4"x4" and BS 3"x3" boxes

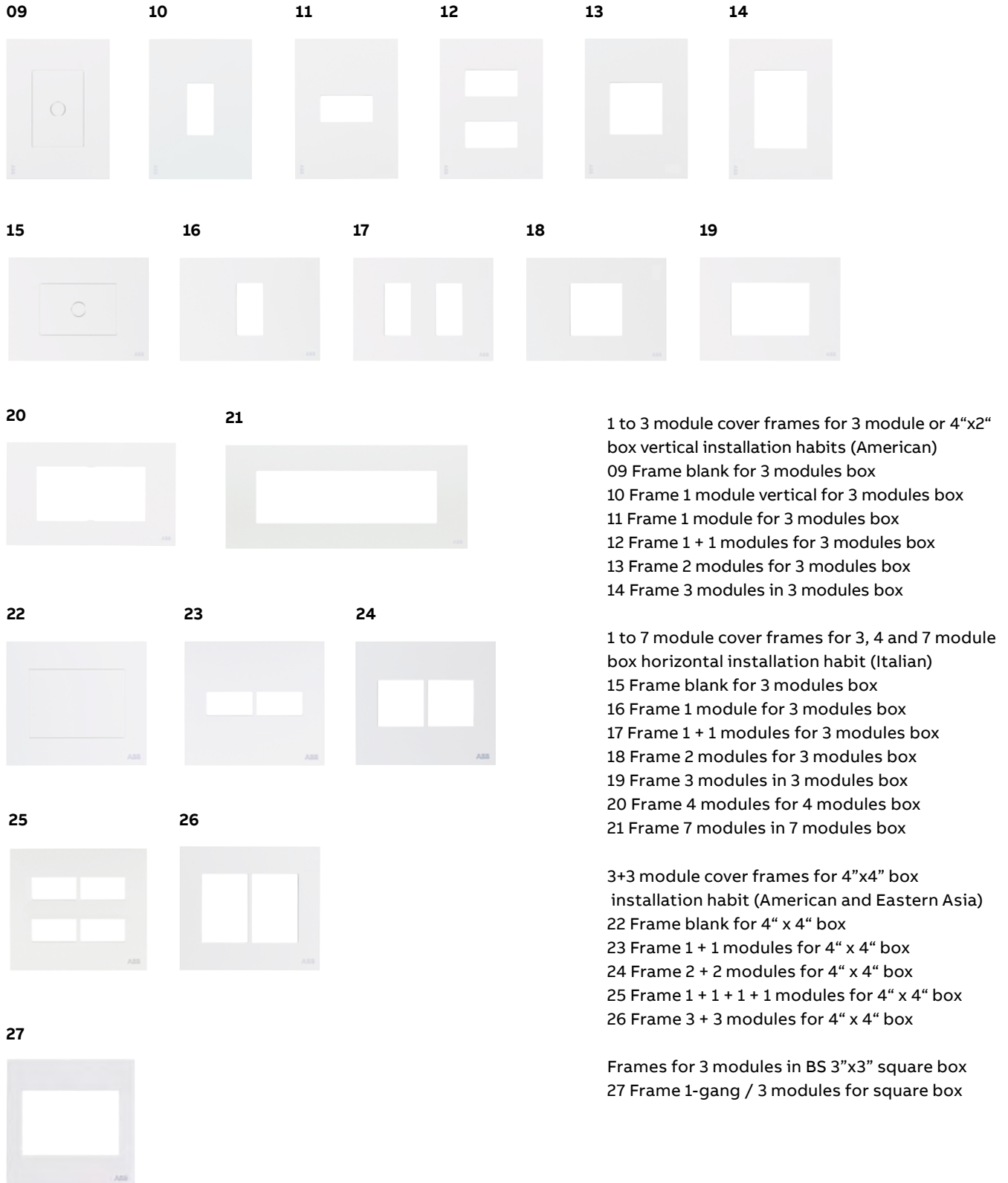

## Zenit Float

Frames for European square and round boxes

**BL - White**



**CB - White Glass**



**CC - Coffee Glass**



**PZ - Slate**



**PL - Silver**



**CN - Black Glass**



**CF - Graphite Glass**



**OX - Stainless Steel**



**AN - Anthracite**

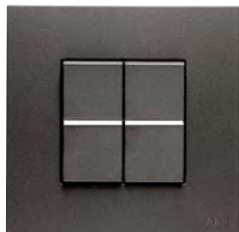

**CP - Pearl Glass**



**CH - Champagne Glass**



**WG - Wenge**



**CV - Champagne**



Logo placement in horizontal and vertical installations

**Niessen logo - Horizontal**

**Niessen logo - Vertical**

**ABB logo - Horizontal**

**ABB logo - Vertical**



---

## Zenit Float

Frames for 3M (4"x2"), 4M, 7M, 4"x4" and 4"x4" boxes

**BL - White**



**CB - White Glass**

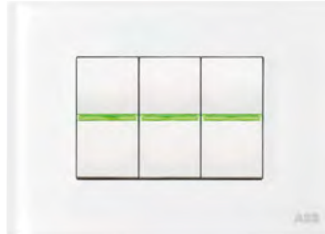

**CF - Graphite Glass**



**PL - Silver**



**CN - Black Glass**



**CH - Champagne Glass**



**AN - Anthracite**



**CP - Pearl Glass**



**OX - Stainless Steel**

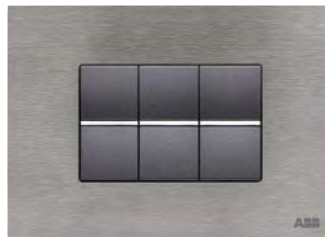

**CV - Champagne**



**CC - Coffee Glass**



**WG - Wenge**



**PZ - Slate**



## Zenit Float - Niessen logo

Frames for European square and round boxes

Size	Modularity	Article-No.	Order-No.	Pack/Qty
------	------------	-------------	-----------	----------



### Frames 1 to 5-gang - Polycarbonate

Material: polycarbonate

Size (height x width):

- 1-gang: 85 x 85 mm.
- 2-gang: 85 x 156 mm.
- 3-gang: 85 x 227 mm.
- 4-gang: 85 x 298 mm.
- 5-gang: 85 x 369 mm.

Mounting grid code suitable for 60 mm screw distance boxes: N2271.9, N2271.9G, N2272.9 and N2273.9 (N2272.9 and N2273.9 only for horizontal installation).

Flush mounting boxes code: 1099, 1999 & 1999.2.

Surface mounting boxes code: 8591, 8592 & 8593.

### White

1-gang	1	<b>N2171 BL</b>	2CLA217100N1101	20
1-gang	2	<b>N2271 BL</b>	2CLA227100N1101	20
2-gang	2+2	<b>N2272 BL</b>	2CLA227200N1101	10
3-gang	2+2+2	<b>N2273 BL</b>	2CLA227300N1101	5
4-gang	2+2+2+2	<b>N2274 BL</b>	2CLA227400N1101	5
5-gang	2+2+2+2+2	<b>N2275 BL</b>	2CLA227500N1101	5

### Silver

1-gang	1	<b>N2171 PL</b>	2CLA217100N1301	20
1-gang	2	<b>N2271 PL</b>	2CLA227100N1301	20
2-gang	2+2	<b>N2272 PL</b>	2CLA227200N1301	10
3-gang	2+2+2	<b>N2273 PL</b>	2CLA227300N1301	5
4-gang	2+2+2+2	<b>N2274 PL</b>	2CLA227400N1301	5
5-gang	2+2+2+2+2	<b>N2275 PL</b>	2CLA227500N1301	5

### Anthracite

1-gang	1	<b>N2171 AN</b>	2CLA217100N1801	20
1-gang	2	<b>N2271 AN</b>	2CLA227100N1801	20
2-gang	2+2	<b>N2272 AN</b>	2CLA227200N1801	10
3-gang	2+2+2	<b>N2273 AN</b>	2CLA227300N1801	5
4-gang	2+2+2+2	<b>N2274 AN</b>	2CLA227400N1801	5
5-gang	2+2+2+2+2	<b>N2275 AN</b>	2CLA227500N1801	5

### Champagne

1-gang	1	<b>N2171 CV</b>	2CLA217100N1901	20
1-gang	2	<b>N2271 CV</b>	2CLA227100N1901	20
2-gang	2+2	<b>N2272 CV</b>	2CLA227200N1901	10
3-gang	2+2+2	<b>N2273 CV</b>	2CLA227300N1901	5
4-gang	2+2+2+2	<b>N2274 CV</b>	2CLA227400N1901	5
5-gang	2+2+2+2+2	<b>N2275 CV</b>	2CLA227500N1901	5

Size	Modularity	Article-No.	Order-No.	Pack/Qty
------	------------	-------------	-----------	----------



### Frames 1 to 4-gang - Noble - Glass

Material: 4mm thickness glass

Size (height x width):

- 1-gang: 90 x 90 mm.
- 2-gang: 90 x 161 mm.
- 3-gang: 90 x 232 mm.
- 4-gang: 90 x 303 mm.

Mounting grid code suitable for 60 mm screw distance boxes: N2271.9, N2271.9G, N2272.9 and N2273.9 (N2272.9 and N2273.9 only for horizontal installation).

Flush mounting boxes code: 1099, 1999 & 1999.2.

Surface mounting boxes code: 8591, 8592 & 8593.

### White Glass

1-gang	2	<b>N2271 CB</b>	2CLA227100N3001	1
2-gang	2+2	<b>N2272 CB</b>	2CLA227200N3001	1
3-gang	2+2+2	<b>N2273 CB</b>	2CLA227300N3001	1
4-gang	2+2+2+2	<b>N2274 CB</b>	2CLA227400N3001	1

### Black Glass

1-gang	2	<b>N2271 CN</b>	2CLA227100N3101	1
2-gang	2+2	<b>N2272 CN</b>	2CLA227200N3101	1
3-gang	2+2+2	<b>N2273 CN</b>	2CLA227300N3101	1
4-gang	2+2+2+2	<b>N2274 CN</b>	2CLA227400N3101	1

### Pearl Glass

1-gang	2	<b>N2271 CP</b>	2CLA227100N3501	1
2-gang	2+2	<b>N2272 CP</b>	2CLA227200N3501	1
3-gang	2+2+2	<b>N2273 CP</b>	2CLA227300N3501	1
4-gang	2+2+2+2	<b>N2274 CP</b>	2CLA227400N3501	1

### Coffee Glass

1-gang	2	<b>N2271 CC</b>	2CLA227100N3701	1
2-gang	2+2	<b>N2272 CC</b>	2CLA227200N3701	1
3-gang	2+2+2	<b>N2273 CC</b>	2CLA227300N3701	1
4-gang	2+2+2+2	<b>N2274 CC</b>	2CLA227400N3701	1

### Graphite Glass

1-gang	2	<b>N2271 CF</b>	2CLA227100N3801	1
2-gang	2+2	<b>N2272 CF</b>	2CLA227200N3801	1
3-gang	2+2+2	<b>N2273 CF</b>	2CLA227300N3801	1
4-gang	2+2+2+2	<b>N2274 CF</b>	2CLA227400N3801	1

### Champagne Glass

1-gang	2	<b>N2271 CH</b>	2CLA227100N3901	1
2-gang	2+2	<b>N2272 CH</b>	2CLA227200N3901	1
3-gang	2+2+2	<b>N2273 CH</b>	2CLA227300N3901	1
4-gang	2+2+2+2	<b>N2274 CH</b>	2CLA227400N3901	1



## Zenit Float - Niessen logo

Frames for square and round European boxes

Size	Modularity	Article-No.	Order-No.	Pack/Qty
------	------------	-------------	-----------	----------



### Frames 1 to 4-gang - Noble - Slate

Material: slate

Size (height x width):

- 1-gang: 90 x 90 mm.

- 2-gang: 90 x 161 mm.

- 3-gang: 90 x 232 mm.

- 4-gang: 90 x 303 mm.

Mounting grid code suitable for 60 mm screw distance boxes: N2271.9, N2271.9G, N2272.9 and N2273.9 (N2272.9 and N2273.9 only for horizontal installation).

Flush mounting boxes code: 1099, 1999 & 1999.2.

Surface mounting boxes code: 8591, 8592 & 8593.

### Slate

1-gang	1	<b>N2271 PZ</b>	2CLA227100N2201	1
2-gang	2+2	<b>N2272 PZ</b>	2CLA227200N2201	1
3-gang	2+2+2	<b>N2273 PZ</b>	2CLA227300N2201	1
4-gang	2+2+2+2	<b>N2274 PZ</b>	2CLA227400N2201	1



### Frames 1 to 4-gang - Noble - Stainless Steel

Material: stainless steel

Size (height x width):

- 1-gang: 90 x 90 mm.

- 2-gang: 90 x 161 mm.

- 3-gang: 90 x 232 mm.

- 4-gang: 90 x 303 mm.

Mounting grid code suitable for 60 mm screw distance boxes: N2271.9, N2271.9G, N2272.9 and N2273.9 (N2272.9 and N2273.9 only for horizontal installation).

Flush mounting boxes code: 1099, 1999 & 1999.2.

Surface mounting boxes code: 8591, 8592 & 8593.

### Stainless Steel

1-gang	1	<b>N2271 OX</b>	2CLA227100N4001	1
2-gang	2+2	<b>N2272 OX</b>	2CLA227200N4001	1
3-gang	2+2+2	<b>N2273 OX</b>	2CLA227300N4001	1
4-gang	2+2+2+2	<b>N2274 OX</b>	2CLA227400N4001	1



### Frames 1 to 4-gang - Noble - Wenge

Material: wood

Size (height x width):

- 1-gang: 90 x 90 mm.

- 2-gang: 90 x 161 mm.

- 3-gang: 90 x 232 mm.

- 4-gang: 90 x 303 mm.

Mounting grid code suitable for 60 mm screw distance boxes: N2271.9, N2271.9G, N2272.9 and N2273.9 (N2272.9 and N2273.9 only for horizontal installation).

Flush mounting boxes code: 1099, 1999 & 1999.2.

Surface mounting boxes code: 8591, 8592 & 8593.

### Wenge

1-gang	1	<b>N2271 WG</b>	2CLA227100N2101	1
2-gang	2+2	<b>N2272 WG</b>	2CLA227200N2101	1
3-gang	2+2+2	<b>N2273 WG</b>	2CLA227300N2101	1
4-gang	2+2+2+2	<b>N2274 WG</b>	2CLA227400N2101	1

## Zenit Float - Niessen logo

Frames for rectangular 3M (4"x2"), 4M and 7M boxes

Size	Modularity	Article-No.	Order-No.	Pack/Qty
------	------------	-------------	-----------	----------



### Frames - 3, 4 and 7 modules - Polycarbonate

Material: polycarbonate

Size (height x width):

- 3M: 117 x 85 mm.

- 4M: 139 x 85 mm.

- 7M: 205 x 85 mm.

Mounting plate codes:

- For 3M box (83,5 mm screw distance): N2371.9 and N2473.9 (N2371.9 only for vertical installation with frames N2371.1 and N2372.1).

- For 4M box (107 mm screw distance): N2474.9.

- For 7M box (100 mm screw distance): N2777.9.

Mounting box codes:

- 3M flush mounting: 499.3 / Surface mounting N2993.

- 4M flush mounting: 1499.4 / Surface mounting N2994.

- 7M flush mounting: 1499.7.

### White

3M	1	<b>N2471 BL</b>	2CLA247100N1101	20
3M	2	<b>N2472 BL</b>	2CLA247200N1101	20
3M	1+1	<b>N2472.2 BL</b>	2CLA247220N1101	20
3M	3	<b>N2473 BL</b>	2CLA247300N1101	20
4M	4	<b>N2474 BL</b>	2CLA247400N1101	10
7M	7	<b>N2777 BL</b>	2CLA277700N1101	5

### Silver

3M	1	<b>N2471 PL</b>	2CLA247100N1301	20
3M	2	<b>N2472 PL</b>	2CLA247200N1301	20
3M	1+1	<b>N2472.2 PL</b>	2CLA247220N1301	20
3M	3	<b>N2473 PL</b>	2CLA247300N1301	20
4M	4	<b>N2474 PL</b>	2CLA247400N1301	10
7M	7	<b>N2777 PL</b>	2CLA277700N1301	5

### Anthracite

3M	1	<b>N2471 AN</b>	2CLA247100N1801	20
3M	2	<b>N2472 AN</b>	2CLA247200N1801	20
3M	1+1	<b>N2472.2 AN</b>	2CLA247220N1801	20
3M	3	<b>N2473 AN</b>	2CLA247300N1801	20
4M	4	<b>N2474 AN</b>	2CLA247400N1801	10
7M	7	<b>N2777 AN</b>	2CLA277700N1801	5

### Champagne

3M	1	<b>N2471 CV</b>	2CLA247100N1901	20
3M	2	<b>N2472 CV</b>	2CLA247200N1901	20
3M	1+1	<b>N2472.2 CV</b>	2CLA247220N1901	20
3M	3	<b>N2473 CV</b>	2CLA247300N1901	20
4M	4	<b>N2474 CV</b>	2CLA247400N1901	10
7M	7	<b>N2777 CV</b>	2CLA277700N1901	5

Size	Modularity	Article-No.	Order-No.	Pack/Qty
------	------------	-------------	-----------	----------



### Frames - 3, 4 and 7 modules - Noble - Glass

Material: 4mm thickness glass

Size (height x width):

- 3M: 122 x 90 mm.

- 4M: 142 x 90 mm.

- 7M: 208 x 90 mm.

Mounting plate codes:

- For 3M box (83,5 mm screw distance): N2371.9 and N2473.9 (N2371.9 only for vertical installation with frames N2371.1 and N2372.1).

- For 4M box (107 mm screw distance): N2474.9.

- For 7M box (100 mm screw distance): N2777.9.

Mounting box codes:

- 3M flush mounting: 499.3 / Surface mounting N2993.

- 4M flush mounting: 1499.4 / Surface mounting N2994.

- 7M flush mounting: 1499.7.

Codes N2474 CP/CC/CF/CH and N2777 XX without logo.

### White Glass

3M	2	<b>N2472 CB</b>	2CLA247200N3001	2
3M	3	<b>N2473 CB</b>	2CLA247300N3001	2
4M	4	<b>N2474 CB</b>	2CLA247400N3001	2
7M	7	<b>N2777 CB</b>	2CLA277700N3002	1

### Black Glass

3M	2	<b>N2472 CN</b>	2CLA247200N3101	2
3M	3	<b>N2473 CN</b>	2CLA247300N3101	2
4M	4	<b>N2474 CN</b>	2CLA247400N3101	2
7M	7	<b>N2777 CN</b>	2CLA277700N3102	1

### Pearl Glass

3M	3	<b>N2473 CP</b>	2CLA247300N3501	2
4M	4	<b>N2474 CP</b>	2CLA247400N3502	2
7M	7	<b>N2777 CP</b>	2CLA277700N3502	1

### Coffee Glass

3M	3	<b>N2473 CC</b>	2CLA247300N3701	2
4M	4	<b>N2474 CC</b>	2CLA247400N3702	2
7M	7	<b>N2777 CC</b>	2CLA277700N3702	1

### Graphite Glass

3M	3	<b>N2473 CF</b>	2CLA247300N3801	2
4M	4	<b>N2474 CF</b>	2CLA247400N3802	2
7M	7	<b>N2777 CF</b>	2CLA277700N3802	1

### Champagne Glass

3M	3	<b>N2473 CH</b>	2CLA247300N3901	2
4M	4	<b>N2474 CH</b>	2CLA247400N3902	2
7M	7	<b>N2777 CH</b>	2CLA277700N3902	1

## Zenit Float - Niessen logo

Frames for rectangular 3M (4"x2"), 4M and 7M boxes

Size	Modularity	Article-No.	Order-No.	Pack/Qty
------	------------	-------------	-----------	----------



### Frames - 3, 4 and 7 modules - Noble - Slate

Material: 4mm thickness slate

Size (height x width):

- 3M: 122 x 90 mm.

- 4M: 142 x 90 mm.

- 7M: 208 x 90 mm.

Mounting plate codes:

- For 3M box (83,5 mm screw distance): N2371.9 and N2473.9 (N2371.9 only for vertical installation with frames N2371.1 and N2372.1).

- For 4M box (107 mm screw distance): N2474.9.

- For 7M box (100 mm screw distance): N2777.9.

Mounting box codes:

- 3M flush mounting: 499.3 / Surface mounting N2993.

- 4M flush mounting: 1499.4 / Surface mounting N2994.

- 7M flush mounting: 1499.7.

Code N2777 PZ without logo.

### Slate

3M	2	<b>N2472 PZ</b>	2CLA247200N2201	2
3M	3	<b>N2473 PZ</b>	2CLA247300N2201	2
4M	4	<b>N2474 PZ</b>	2CLA247400N2201	2
7M	7	<b>N2777 PZ</b>	2CLA277700N2202	1

Size	Modularity	Article-No.	Order-No.	Pack/Qty
------	------------	-------------	-----------	----------



### Frames - 3, 4 and 7 modules - Noble - Wenge

Material: 4mm thickness wood

Size (height x width):

- 3M: 122 x 90 mm.

- 4M: 142 x 90 mm.

- 7M: 208 x 90 mm.

Mounting plate codes:

- For 3M box (83,5 mm screw distance): N2371.9 (only frames N2371.1 and N2372.1) & N2473.9.

- For 4M box (107 mm screw distance): N2474.9.

- For 7M box (100 mm screw distance): N2777.9.

Mounting box codes:

- 3M flush mounting: 499.3 / Surface mounting N2993.

- 4M flush mounting: 1499.4 / Surface mounting N2994.

- 7M flush mounting: 1499.7.

Code N2777 WG without logo.

### Wenge

3M	2	<b>N2472 WG</b>	2CLA247200N2101	2
3M	3	<b>N2473 WG</b>	2CLA247300N2101	2
4M	4	<b>N2474 WG</b>	2CLA247400N2101	2
7M	7	<b>N2777 WG</b>	2CLA277700N2102	1



### Frames - 3, 4 and 7 modules - Noble - Stainless Steel

Material: 4mm thickness stainless steel

Size (height x width):

- 3M: 122 x 90 mm.

- 4M: 142 x 90 mm.

- 7M: 208 x 90 mm.

Mounting plate codes:

- For 3M box (83,5 mm screw distance): N2371.9 (only frames N2371.1 and N2372.1) & N2473.9.

- For 4M box (107 mm screw distance): N2474.9.

- For 7M box (100 mm screw distance): N2777.9.

Mounting box codes:

- 3M flush mounting: 499.3 / Surface mounting N2993.

- 4M flush mounting: 1499.4 / Surface mounting N2994.

- 7M flush mounting: 1499.7.

Code N2777 OX without logo.

### Stainless Steel

3M	2	<b>N2472 OX</b>	2CLA247200N4001	2
3M	3	<b>N2473 OX</b>	2CLA247300N4001	2
4M	4	<b>N2474 OX</b>	2CLA247400N4001	2
7M	7	<b>N2777 OX</b>	2CLA277700N4002	1

## Zenit Float - ABB logo

Frames for European square and round boxes

Size	Modularity	Article-No.	Order-No.	Pack/Qty
------	------------	-------------	-----------	----------



### Frames 1 to 5-gang - Polycarbonate

Material: polycarbonate

Size (height x width):

- 1-gang: 85 x 85 mm.

- 2-gang: 85 x 156 mm.

- 3-gang: 85 x 227 mm.

- 4-gang: 85 x 298 mm.

- 5-gang: 85 x 369 mm.

Mounting grid code suitable for 60 mm screw distance boxes: N2271.9, N2271.9G, N2272.9 and N2273.9 (N2272.9 and N2273.9 only for horizontal installation).

Flush mounting boxes code: 1099, 1999 & 1999.2.

Surface mounting boxes code: 8591, 8592 & 8593.

### White

1-gang 1		<b>N2171 BL</b>	2CLA217100N1102	20
1-gang 2		<b>N2271 BL</b>	2CLA227100N1102	20
2-gang 2+2		<b>N2272 BL</b>	2CLA227200N1102	10
3-gang 2+2+2		<b>N2273 BL</b>	2CLA227300N1102	5
4-gang 2+2+2+2		<b>N2274 BL</b>	2CLA227400N1102	5
5-gang 2+2+2+2+2		<b>N2275 BL</b>	2CLA227500N1102	5

### Silver

1-gang 1		<b>N2171 PL</b>	2CLA217100N1302	20
1-gang 2		<b>N2271 PL</b>	2CLA227100N1302	20
2-gang 2+2		<b>N2272 PL</b>	2CLA227200N1302	10
3-gang 2+2+2		<b>N2273 PL</b>	2CLA227300N1302	5
4-gang 2+2+2+2		<b>N2274 PL</b>	2CLA227400N1302	5
5-gang 2+2+2+2+2		<b>N2275 PL</b>	2CLA227500N1302	5

### Anthracite

1-gang 1		<b>N2171 AN</b>	2CLA217100N1802	20
1-gang 2		<b>N2271 AN</b>	2CLA227100N1802	20
2-gang 2+2		<b>N2272 AN</b>	2CLA227200N1802	10
3-gang 2+2+2		<b>N2273 AN</b>	2CLA227300N1802	5
4-gang 2+2+2+2		<b>N2274 AN</b>	2CLA227400N1802	5
5-gang 2+2+2+2+2		<b>N2275 AN</b>	2CLA227500N1802	5

### Champagne

1-gang 1		<b>N2171 CV</b>	2CLA217100N1902	20
1-gang 2		<b>N2271 CV</b>	2CLA227100N1902	20
2-gang 2+2		<b>N2272 CV</b>	2CLA227200N1902	10
3-gang 2+2+2		<b>N2273 CV</b>	2CLA227300N1902	5
4-gang 2+2+2+2		<b>N2274 CV</b>	2CLA227400N1902	5
5-gang 2+2+2+2+2		<b>N2275 CV</b>	2CLA227500N1902	5

Size	Modularity	Article-No.	Order-No.	Pack/Qty
------	------------	-------------	-----------	----------



### Frames 1 to 4-gang - Noble - Glass

Material: 4mm thickness glass

Size (height x width):

- 1-gang: 90 x 90 mm.

- 2-gang: 90 x 161 mm.

- 3-gang: 90 x 232 mm.

- 4-gang: 90 x 303 mm.

Mounting grid code suitable for 60 mm screw distance boxes: N2271.9, N2271.9G, N2272.9 and N2273.9 (N2272.9 and N2273.9 only for horizontal installation).

Flush mounting boxes code: 1099, 1999 & 1999.2.

Surface mounting boxes code: 8591, 8592 & 8593.

### White Glass

1-gang 2		<b>N2271 CB</b>	2CLA227100N3002	1
2-gang 2+2		<b>N2272 CB</b>	2CLA227200N3002	1
3-gang 2+2+2		<b>N2273 CB</b>	2CLA227300N3002	1
4-gang 2+2+2+2		<b>N2274 CB</b>	2CLA227400N3002	1

### Black Glass

1-gang 2		<b>N2271 CN</b>	2CLA227100N3102	1
2-gang 2+2		<b>N2272 CN</b>	2CLA227200N3102	1
3-gang 2+2+2		<b>N2273 CN</b>	2CLA227300N3102	1
4-gang 2+2+2+2		<b>N2274 CN</b>	2CLA227400N3102	1

### Pearl Glass

1-gang 2		<b>N2271 CP</b>	2CLA227100N3502	1
2-gang 2+2		<b>N2272 CP</b>	2CLA227200N3502	1
3-gang 2+2+2		<b>N2273 CP</b>	2CLA227300N3502	1
4-gang 2+2+2+2		<b>N2274 CP</b>	2CLA227400N3502	1

### Coffee Glass

1-gang 2		<b>N2271 CC</b>	2CLA227100N3702	1
2-gang 2+2		<b>N2272 CC</b>	2CLA227200N3702	1
3-gang 2+2+2		<b>N2273 CC</b>	2CLA227300N3702	1
4-gang 2+2+2+2		<b>N2274 CC</b>	2CLA227400N3702	1

### Graphite Glass

1-gang 2		<b>N2271 CF</b>	2CLA227100N3802	1
2-gang 2+2		<b>N2272 CF</b>	2CLA227200N3802	1
3-gang 2+2+2		<b>N2273 CF</b>	2CLA227300N3802	1
4-gang 2+2+2+2		<b>N2274 CF</b>	2CLA227400N3802	1

### Champagne Glass

1-gang 2		<b>N2271 CH</b>	2CLA227100N3902	1
2-gang 2+2		<b>N2272 CH</b>	2CLA227200N3902	1
3-gang 2+2+2		<b>N2273 CH</b>	2CLA227300N3902	1
4-gang 2+2+2+2		<b>N2274 CH</b>	2CLA227400N3902	1

## Zenit Float - ABB logo

Frames for European square and round boxes

Size	Modularity	Article-No.	Order-No.	Pack/Qty
------	------------	-------------	-----------	----------



### Frames 1 to 4-gang - Noble - Slate

Material: 4mm thickness slate

Size (height x width):

- 1-gang: 90 x 90 mm.
- 2-gang: 90 x 161 mm.
- 3-gang: 90 x 232 mm.
- 4-gang: 90 x 303 mm.

Mounting grid code suitable for 60 mm. screw distance boxes: N2271.9, N2271.9G, N2272.9 and N2273.9 (N2272.9 and N2273.9 only for horizontal installation).

Flush mounting boxes code: 1099, 1999 & 1999.2.  
Surface mounting boxes code: 8591, 8592 & 8593.

### Slate

1-gang	1	<b>N2271 PZ</b>	2CLA227100N2202	1
2-gang	2+2	<b>N2272 PZ</b>	2CLA227200N2202	1
3-gang	2+2+2	<b>N2273 PZ</b>	2CLA227300N2202	1
4-gang	2+2+2+2	<b>N2274 PZ</b>	2CLA227400N2202	1



### Frames 1 to 4-gang - Noble - Stainless Steel

Material: 4mm thickness stainless steel

Size (height x width):

- 1-gang: 90 x 90 mm.
- 2-gang: 90 x 161 mm.
- 3-gang: 90 x 232 mm.
- 4-gang: 90 x 303 mm.

Mounting grid code suitable for 60 mm. screw distance boxes: N2271.9, N2271.9G, N2272.9 and N2273.9 (N2272.9 and N2273.9 only for horizontal installation).

Flush mounting boxes code: 1099, 1999 & 1999.2.  
Surface mounting boxes code: 8591, 8592 & 8593.

### Stainless Steel

1-gang	1	<b>N2271 OX</b>	2CLA227100N4002	1
2-gang	2+2	<b>N2272 OX</b>	2CLA227200N4002	1
3-gang	2+2+2	<b>N2273 OX</b>	2CLA227300N4002	1
4-gang	2+2+2+2	<b>N2274 OX</b>	2CLA227400N4002	1



### Frames 1 to 4-gang - Noble - Wenge

Material: 4mm thickness wood

Size (height x width):

- 1-gang: 90 x 90 mm.
- 2-gang: 90 x 161 mm.
- 3-gang: 90 x 232 mm.
- 4-gang: 90 x 303 mm.

Mounting grid code suitable for 60 mm. screw distance boxes: N2271.9, N2271.9G, N2272.9 and N2273.9 (N2272.9 and N2273.9 only for horizontal installation).

Flush mounting boxes code: 1099, 1999 & 1999.2.  
Surface mounting boxes code: 8591, 8592 & 8593.

### Wenge

1-gang	1	<b>N2271 WG</b>	2CLA227100N2102	1
2-gang	2+2	<b>N2272 WG</b>	2CLA227200N2102	1
3-gang	2+2+2	<b>N2273 WG</b>	2CLA227300N2102	1
4-gang	2+2+2+2	<b>N2274 WG</b>	2CLA227400N2102	1

## Zenit Float - ABB logo

Frames for rectangular 3M (4"x2"), 4M and 7M boxes

Size	Modularity	Article-No.	Order-No.	Pack/Qty
------	------------	-------------	-----------	----------



### Frames - 3, 4 and 7 modules - Polycarbonate

Material: polycarbonate

Size (height x width):

- 3M: 122 x 90 mm.

- 4M: 139 x 85 mm.

- 7M: 205 x 85 mm.

Mounting plate codes:

- For 3M box (83,5 mm screw distance): N2371.9 and N2473.9 (N2371.9 only for vertical installation with

frames N2371.1 and N2372.1).

- For 4M box (107 mm screw distance): N2474.9.

- For 7M box (100 mm screw distance): N2777.9.

Mounting box codes:

- 3M flush mounting: 499.3 / Surface mounting N2993.

- 4M flush mounting: 1499.4 / Surface mounting N2994.

- 7M flush mounting: 1499.7.

### White

3M	Blank	<b>N2370.1 BL</b>	2CLA237010N1102	20
3M	1	<b>N2371.1 BL</b>	2CLA237110N1102	20
3M	1 Vert.	<b>N2371.1V BL</b>	2CLA237190N1102	20
3M	2	<b>N2372.1 BL</b>	2CLA237210N1102	20
3M	1+1	<b>N2372.2 BL</b>	2CLA237220N1102	20
3M	3	<b>N2373.1 BL</b>	2CLA237310N1102	20
4M	4	<b>N2374.1 BL</b>	2CLA237410N1102	10
7M	7	<b>N2777.1 BL</b>	2CLA277710N1102	5

### Silver

3M	Blank	<b>N2370.1 PL</b>	2CLA237010N1302	20
3M	1	<b>N2371.1 PL</b>	2CLA237110N1302	20
3M	1 Vert.	<b>N2371.1V PL</b>	2CLA237190N1302	20
3M	2	<b>N2372.1 PL</b>	2CLA237210N1302	20
3M	1+1	<b>N2372.2 PL</b>	2CLA237220N1302	20
3M	3	<b>N2373.1 PL</b>	2CLA237310N1302	20
4M	4	<b>N2374.1 PL</b>	2CLA237410N1302	10
7M	7	<b>N2777.1 PL</b>	2CLA277710N1302	5

### Anthracite

3M	Blank	<b>N2370.1 AN</b>	2CLA237010N1802	20
3M	1	<b>N2371.1 AN</b>	2CLA237110N1802	20
3M	1 Vert.	<b>N2371.1V AN</b>	2CLA237190N1802	20
3M	2	<b>N2372.1 AN</b>	2CLA237210N1802	20
3M	1+1	<b>N2372.2 AN</b>	2CLA237220N1802	20
3M	3	<b>N2373.1 AN</b>	2CLA237310N1802	20
4M	4	<b>N2374.1 AN</b>	2CLA237410N1802	10
7M	7	<b>N2777.1 AN</b>	2CLA277710N1802	5

### Champagne

3M	Blank	<b>N2370.1 CV</b>	2CLA237010N1902	20
3M	1	<b>N2371.1 CV</b>	2CLA237110N1902	20
3M	1 Vert.	<b>N2371.1V CV</b>	2CLA237190N1902	20
3M	2	<b>N2372.1 CV</b>	2CLA237210N1902	20
3M	1+1	<b>N2372.2 CV</b>	2CLA237220N1902	20
3M	3	<b>N2373.1 CV</b>	2CLA237310N1902	20
4M	4	<b>N2374.1 CV</b>	2CLA237410N1902	10
7M	7	<b>N2777.1 CV</b>	2CLA277710N1902	5

Size	Modularity	Article-No.	Order-No.	Pack/Qty
------	------------	-------------	-----------	----------



### Frames - 3, 4 and 7 modules - Noble - Glass

Material: 4mm thickness glass

Size (height x width):

- 3M: 122 x 90 mm.

- 4M: 142 x 90 mm.

- 7M: 208 x 90 mm.

Mounting plate codes:

- For 3M box (83,5 mm screw distance): N2371.9 and N2473.9 (N2371.9 only for vertical installation with

frames N2371.1 and N2372.1).

- For 4M box (107 mm screw distance): N2474.9.

- For 7M box (100 mm screw distance): N2777.9.

Mounting box codes:

- 3M flush mounting: 499.3 / Surface mounting N2993.

- 4M flush mounting: 1499.4 / Surface mounting N2994.

- 7M flush mounting: 1499.7.

Codes N2474 CP/CC/CF/CH and N2777 XX without logo.

### White Glass

3M	2	<b>N2372.1 CB</b>	2CLA237200N3002	2
3M	3	<b>N2373.1 CB</b>	2CLA237300N3002	2
4M	4	<b>N2374.1 CB</b>	2CLA237400N3002	2
7M	7	<b>N2777 CB</b>	2CLA277700N3002	1

### Black Glass

3M	2	<b>N2372.1 CN</b>	2CLA237200N3102	2
3M	3	<b>N2373.1 CN</b>	2CLA237300N3102	2
4M	4	<b>N2373.1 CN</b>	2CLA237400N3102	2
7M	7	<b>N2777 CN</b>	2CLA277700N3102	1

### Pearl Glass

3M	3	<b>N2373.1 CP</b>	2CLA237300N3502	2
4M	4	<b>N2474 CP</b>	2CLA247400N3502	2
7M	7	<b>N2777 CP</b>	2CLA277700N3502	1

### Coffee Glass

3M	3	<b>N2373.1 CC</b>	2CLA237300N3702	2
4M	4	<b>N2474 CC</b>	2CLA247400N3702	2
7M	7	<b>N2777 CC</b>	2CLA277700N3702	1

### Graphite Glass

3M	3	<b>N2373.1 CF</b>	2CLA237300N3802	2
4M	4	<b>N2474 CF</b>	2CLA247400N3802	2
7M	7	<b>N2777 CF</b>	2CLA277700N3802	1

### Champagne Glass

3M	3	<b>N2373.1 CH</b>	2CLA237300N3902	2
4M	4	<b>N2474 CH</b>	2CLA247400N3902	2
7M	7	<b>N2777 CH</b>	2CLA277700N3902	1

## Zenit Float - ABB logo

Frames for rectangular 3M (4"x2"), 4M and 7M boxes

Size	Modularity	Article-No.	Order-No.	Pack/Qty
------	------------	-------------	-----------	----------



### Frames - 3, 4 and 7 modules - Noble - Slate

Material: 4mm thickness slate

Size (height x width):

- 3M: 122 x 90 mm.

- 4M: 142 x 90 mm.

- 7M: 208 x 90 mm.

Mounting plate codes:

- For 3M box (83,5 mm screw distance): N2371.9 and N2473.9 (N2371.9 only for vertical installation with

frames N2371.1 and N2372.1).

- For 4M box (107 mm screw distance): N2474.9.

- For 7M box (100 mm screw distance): N2777.9.

Mounting box codes:

- 3M flush mounting: 499.3 / Surface mounting N2993.

- 4M flush mounting: 1499.4 / Surface mounting N2994.

- 7M flush mounting: 1499.7.

Code N2777 PZ without logo.

### Slate

3M	2	<b>N2372.1 PZ</b>	2CLA237200N2202	2
3M	3	<b>N2373.1 PZ</b>	2CLA237300N2202	2
4M	4	<b>N2374.1 PZ</b>	2CLA237400N2202	2
7M	7	<b>N2777 PZ</b>	2CLA277700N2202	1

Size	Modularity	Article-No.	Order-No.	Pack/Qty
------	------------	-------------	-----------	----------



### Frames - 3, 4 and 7 modules - Noble - Wenge

Material: 4mm thickness wood

Size (height x width):

- 3M: 122 x 90 mm.

- 4M: 142 x 90 mm.

- 7M: 208 x 90 mm.

Mounting plate codes:

- For 3M box (83,5 mm screw distance): N2371.9 and N2473.9 (N2371.9 only for vertical installation with

frames N2371.1 and N2372.1).

- For 4M box (107 mm screw distance): N2474.9.

- For 7M box (100 mm screw distance): N2777.9.

Mounting box codes:

- 3M flush mounting: 499.3 / Surface mounting N2993.

- 4M flush mounting: 1499.4 / Surface mounting N2994.

- 7M flush mounting: 1499.7.

Code N2777 WG without logo.

### Wenge

3M	2	<b>N2372.1 WG</b>	2CLA237210N2102	2
3M	3	<b>N2373.1 WG</b>	2CLA237310N2102	2
4M	4	<b>N2374.1 WG</b>	2CLA237410N2102	2
7M	7	<b>N2777 WG</b>	2CLA277700N2102	1



### Frames - 3, 4 and 7 modules - Noble - Stainless Steel

Material: 4mm thickness stainless steel

Size (height x width):

- 3M: 122 x 90 mm.

- 4M: 142 x 90 mm.

- 7M: 208 x 90 mm.

Mounting plate codes:

- For 3M box (83,5 mm screw distance): N2371.9 (only

frames N2371.1 and N2372.1) & N2473.9.

- For 4M box (107 mm screw distance): N2474.9.

- For 7M box (100 mm screw distance): N2777.9.

Mounting box codes:

- 3M flush mounting: 499.3 / Surface mounting N2993.

- 4M flush mounting: 1499.4 / Surface mounting N2994.

- 7M flush mounting: 1499.7.

Code N2777 OX without logo.

### Stainless Steel

3M	2	<b>N2372.1 OX</b>	2CLA237200N4002	2
3M	3	<b>N2373.1 OX</b>	2CLA237300N4002	2
4M	4	<b>N2374.1 OX</b>	2CLA237400N4002	2
7M	7	<b>N2777 OX</b>	2CLA277700N4002	1

## Zenit Float - ABB logo

Frames for 4"x4" boxes

Size	Modularity	Article-No.	Order-No.	Pack/Qty
------	------------	-------------	-----------	----------



**Frames - 3+3 modules - Polycarbonate**  
Material: polycarbonate  
Size (height x width): 122 x 138 mm.  
Mounting plate code suitable for 4" x 4" boxes:  
N2673.9.

### White

4"x4"	Blank	<b>N2670 BL</b>	2CLA267000N1102	5
4"x4"	1+1	<b>N2671.1 BL</b>	2CLA267110N1102	5
4"x4"	2+2	<b>N2672.2 BL</b>	2CLA267220N1102	5
4"x4"	1+1+1+1	<b>N2672.4 BL</b>	2CLA267240N1102	5
4"x4"	3+3	<b>N2673.6 BL</b>	2CLA267360N1102	5

### Silver

4"x4"	Blank	<b>N2670 PL</b>	2CLA267000N1302	5
4"x4"	1+1	<b>N2671.1 PL</b>	2CLA267110N1302	5
4"x4"	2+2	<b>N2672.2 PL</b>	2CLA267220N1302	5
4"x4"	1+1+1+1	<b>N2672.4 PL</b>	2CLA267240N1302	5
4"x4"	3+3	<b>N2673.6 PL</b>	2CLA267360N1302	5

### Anthracite

4"x4"	Blank	<b>N2670 AN</b>	2CLA267000N1802	5
4"x4"	1+1	<b>N2671.1 AN</b>	2CLA267110N1802	5
4"x4"	2+2	<b>N2672.2 AN</b>	2CLA267220N1802	5
4"x4"	1+1+1+1	<b>N2672.4 AN</b>	2CLA267240N1802	5
4"x4"	3+3	<b>N2673.6 AN</b>	2CLA267360N1802	5

### Champagne

4"x4"	Blank	<b>N2670 CV</b>	2CLA267000N1902	5
4"x4"	1+1	<b>N2671.1 CV</b>	2CLA267110N1902	5
4"x4"	2+2	<b>N2672.2 CV</b>	2CLA267220N1902	5
4"x4"	1+1+1+1	<b>N2672.4 CV</b>	2CLA267240N1902	5
4"x4"	3+3	<b>N2673.6 CV</b>	2CLA267360N1902	5

Size	Modularity	Article-No.	Order-No.	Pack/Qty
------	------------	-------------	-----------	----------



**Frames - 3+3 modules - Noble - Glass**  
Material: 4mm thickness glass  
Size (height x width): 122 x 138 mm.  
Mounting plate code suitable for 4" x 4" boxes:  
N2673.9.

### White Glass

4"x4"	3+3	<b>N2673.6 CB</b>	2CLA267360N3002	2
-------	-----	-------------------	-----------------	---

### Black Glass

4"x4"	3+3	<b>N2673.6 CN</b>	2CLA267360N3102	2
-------	-----	-------------------	-----------------	---

### Pearl Glass

4"x4"	3+3	<b>N2673.6 CP</b>	2CLA267360N3502	2
-------	-----	-------------------	-----------------	---

### Coffee Glass

4"x4"	3+3	<b>N2673.6 CC</b>	2CLA267360N3702	2
-------	-----	-------------------	-----------------	---

### Graphite Glass

4"x4"	3+3	<b>N2673.6 CF</b>	2CLA267360N3802	2
-------	-----	-------------------	-----------------	---

### Champagne Glass

4"x4"	3+3	<b>N2673.6 CH</b>	2CLA267360N3902	2
-------	-----	-------------------	-----------------	---



**Frames - 3+3 modules - Noble - Slate**  
Material: 4mm thickness slate  
Size (height x width): 122 x 138 mm.  
Mounting plate code suitable for 4" x 4" boxes:  
N2673.9.

### Slate

4"x4"	3+3	<b>N2673.6 PZ</b>	2CLA267360N2202	2
-------	-----	-------------------	-----------------	---



**Frames - 3+3 modules - Noble - Stainless Steel**  
Material: 4mm thickness stainless steel  
Size (height x width): 122 x 138 mm.  
Mounting plate code suitable for 4" x 4" boxes:  
N2673.9.

### Stainless Steel

4"x4"	3+3	<b>N2673.6 OX</b>	2CLA267360N4002	2
-------	-----	-------------------	-----------------	---



**Frames - 3+3 modules - Noble - Wenge**  
Material: 4mm thickness wood  
Size (height x width): 122 x 138 mm.  
Mounting plate code suitable for 4" x 4" boxes:  
N2673.9.

### Wenge

4"x4"	3+3	<b>N2673.6 WG</b>	2CLA267360N2102	5
-------	-----	-------------------	-----------------	---



## Zenit Float - ABB logo

Frames for BS 3"x3" boxes

Size	Modularity	Article-No.	Order-No.	Pack/Qty
 <p><b>Frames - 3 modules - polycarbonate</b>            Material: polycarbonate.            Size (height x width): 90 x 90 mm.            Mounting plate code suitable for 60,3 mm screw distance            BS 3"x3" boxes: N2573.9.            Flush mounting boxes code: 1099.</p>				
<b>White</b>				
3"x3"	3	<b>N2573 BL</b>	2CLA257300N1102	20
<b>Silver</b>				
3"x3"	3	<b>N2573 PL</b>	2CLA257300N1302	20
<b>Anthracite</b>				
3"x3"	3	<b>N2573 AN</b>	2CLA257300N1802	20
<b>Champagne</b>				
3"x3"	3	<b>N2573 CV</b>	2CLA257300N1902	20

## Zenit Solid

Frames for European square and round boxes

01



**7,5 mm height.**  
Compact and firm profile. Solid effect with own personality.

02



03



04



05



07

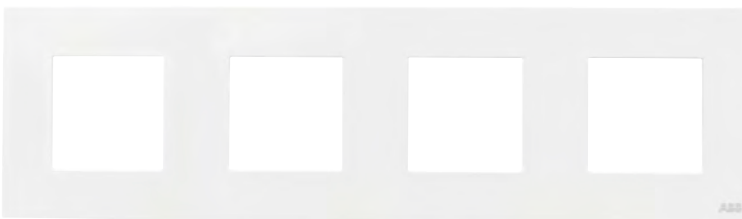

01 Side view, 7,5 x 85 mm

1 to 4-gang cover frame suitable for horizontal and vertical installation

02 Frame 1-gang, 1 module

03 Frame 1-gang, 2 modules

04 Frame 2-gang, 2 + 2 modules

05 Frame 3-gang, 2 + 2 + 2 modules horizontal

06 Frame 3-gang, 2 + 2 + 2 modules vertical

07 Frame 4-gang, 2 + 2 + 2 + 2 modules

1 to 3 module cover frames for 3 module or 4"x2" box vertical installation habits (American)

08 Frame 1 module for 3 modules box

09 Frame 1 + 1 modules for 3 modules box

10 Frame 2 modules for 3 modules box

11 Frame 3 modules in 3 modules box

1 to 3 module cover frames for 3 module box horizontal installation habit (Italian)

12 Frame 1 module for 3 modules box

13 Frame 1 + 1 modules for 3 modules box

14 Frame 2 modules for 3 modules box

15 Frame 3 modules in 3 modules box

06



Frames for rectangular 3M/4"x2" boxes

08



09



10



11

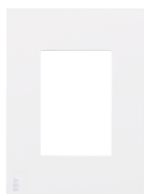

12



13



14



15

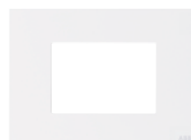

## Zenit Solid

Frames for European square and round boxes

**BL - White**



**PL - Silver**



**AN - Anthracite**

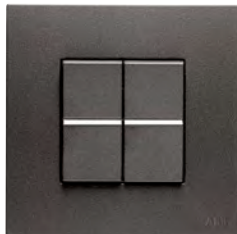

**CV - Champagne**



Frames for rectangular 3M/4"x2" boxes

**BL - White**



**PL - Silver**



**AN - Anthracite**

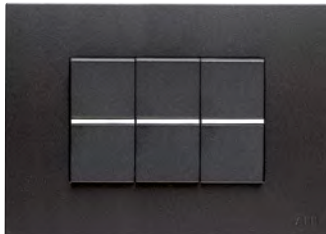

**CV - Champagne**



Logo placement in horizontal and vertical installations

**Niessen Logo - Horizontal**



**Niessen Logo - Vertical**



**ABB Logo - Horizontal**



**ABB Logo - Vertical**



## Zenit Solid - Niessen logo

### Frames for European boxes

Size	Modularity	Article-No.	Order-No.	Pack/Qty
------	------------	-------------	-----------	----------



#### Frames 1 to 5-gang - Polycarbonate

Material: polycarbonate

Size (height x width):

- 1-gang: 85 x 85 mm.

- 2-gang: 85 x 156 mm.

- 3-gang: 85 x 227 mm.

- 4-gang: 85 x 298 mm.

Mounting grid code suitable for 60 mm screw distance boxes: N2271.9, N2271.9G, N2272.9 and N2273.9 (N2272.9 and N2273.9 only for horizontal installation).

Flush mounting boxes code: 1099, 1999 & 1999.2.

Surface mounting boxes code: 8591, 8592 & 8593.

#### White

1-gang	1	<b>N2171.1 BL</b>	2CLA217110N1101	20
1-gang	2	<b>N2271.1 BL</b>	2CLA227110N1101	20
2-gang	2+2	<b>N2272.1 BL</b>	2CLA227210N1101	10
3-gang	2+2+2	<b>N2273.1 BL</b>	2CLA227310N1101	5
4-gang	2+2+2+2	<b>N2274.1 BL</b>	2CLA227410N1101	5

#### Silver

1-gang	1	<b>N2171.1 PL</b>	2CLA217110N1301	20
1-gang	2	<b>N2271.1 PL</b>	2CLA227110N1301	20
2-gang	2+2	<b>N2272.1 PL</b>	2CLA227210N1301	10
3-gang	2+2+2	<b>N2273.1 PL</b>	2CLA227310N1301	5
4-gang	2+2+2+2	<b>N2274.1 PL</b>	2CLA227410N1301	5

#### Anthracite

1-gang	1	<b>N2171.1 AN</b>	2CLA217110N1801	20
1-gang	2	<b>N2271.1 AN</b>	2CLA227110N1801	20
2-gang	2+2	<b>N2272.1 AN</b>	2CLA227210N1801	10
3-gang	2+2+2	<b>N2273.1 AN</b>	2CLA227310N1801	5
4-gang	2+2+2+2	<b>N2274.1 AN</b>	2CLA227410N1801	5

#### Champagne

1-gang	1	<b>N2171.1 CV</b>	2CLA217110N1901	20
1-gang	2	<b>N2271.1 CV</b>	2CLA227110N1901	20
2-gang	2+2	<b>N2272.1 CV</b>	2CLA227210N1901	10
3-gang	2+2+2	<b>N2273.1 CV</b>	2CLA227310N1901	5
4-gang	2+2+2+2	<b>N2274.1 CV</b>	2CLA227410N1901	5

### Frames for rectangular 3M (4"x2") boxes

Size	Modularity	Article-No.	Order-No.	Pack/Qty
------	------------	-------------	-----------	----------



#### Frames - 3 modules - Polycarbonate

Material: polycarbonate

Size (height x width): 117 x 85 mm.

Mounting plate code for 3M box (83,5 mm screw distance): N2371.9 and N2473.9 (N2371.9 only for vertical installation with frames N2371.1 and N2372.1).

Mounting box codes:

- Flush mounting: 499.3

- Surface mounting N2993.

#### White

3M	1	<b>N2471.1 BL</b>	2CLA247110N1101	20
3M	2	<b>N2472.1 BL</b>	2CLA247210N1101	20
3M	1+1	<b>N2472.3 BL</b>	2CLA247230N1101	20
3M	3	<b>N2473.1 BL</b>	2CLA247310N1101	20

#### Silver

3M	1	<b>N2471.1 PL</b>	2CLA247110N1301	20
3M	2	<b>N2472.1 PL</b>	2CLA2472010N1301	20
3M	1+1	<b>N2472.3 PL</b>	2CLA247230N1301	20
3M	3	<b>N2473.1 PL</b>	2CLA247310N1301	20

#### Anthracite

3M	1	<b>N2471.1 AN</b>	2CLA247110N1801	20
3M	2	<b>N2472.1 AN</b>	2CLA247210N1801	20
3M	1+1	<b>N2472.3 AN</b>	2CLA247230N1801	20
3M	3	<b>N2473.1 AN</b>	2CLA247310N1801	20

#### Champagne

3M	1	<b>N2471.1 CV</b>	2CLA247110N1901	20
3M	2	<b>N2472.1 CV</b>	2CLA247210N1901	20
3M	1+1	<b>N2472.3 CV</b>	2CLA247230N1901	20
3M	3	<b>N2473.1 CV</b>	2CLA247310N1901	20

## Zenit Solid - ABB logo

### Frames for European boxes

Size	Modularity	Article-No.	Order-No.	Pack/Qty
------	------------	-------------	-----------	----------



#### Frames 1 to 5-gang - Polycarbonate

Material: polycarbonate

Size (height x width):

- 1-gang: 85 x 85 mm.

- 2-gang: 85 x 156 mm.

- 3-gang: 85 x 227 mm.

- 4-gang: 85 x 298 mm.

Mounting grid code suitable for 60 mm screw distance boxes: N2271.9, N2271.9G, N2272.9 and N2273.9 (N2272.9 and N2273.9 only for horizontal installation).

Flush mounting boxes code: 1099, 1999 & 1999.2.

Surface mounting boxes code: 8591, 8592 & 8593.

#### White

1-gang	1	<b>N2171.1 BL</b>	2CLA217110N1102	20
1-gang	2	<b>N2271.1 BL</b>	2CLA227110N1102	20
2-gang	2+2	<b>N2272.1 BL</b>	2CLA227210N1102	10
3-gang	2+2+2	<b>N2273.1 BL</b>	2CLA227310N1102	5
4-gang	2+2+2+2	<b>N2274.1 BL</b>	2CLA227410N1102	5

#### Silver

1-gang	1	<b>N2171.1 PL</b>	2CLA217110N1302	20
1-gang	2	<b>N2271.1 PL</b>	2CLA227110N1302	20
2-gang	2+2	<b>N2272.1 PL</b>	2CLA227210N1302	10
3-gang	2+2+2	<b>N2273.1 PL</b>	2CLA227310N1302	5
4-gang	2+2+2+2	<b>N2274.1 PL</b>	2CLA227410N1302	5

#### Anthracite

1-gang	1	<b>N2171.1 AN</b>	2CLA217110N1802	20
1-gang	2	<b>N2271.1 AN</b>	2CLA227110N1802	20
2-gang	2+2	<b>N2272.1 AN</b>	2CLA227210N1802	10
3-gang	2+2+2	<b>N2273.1 AN</b>	2CLA227310N1802	5
4-gang	2+2+2+2	<b>N2274.1 AN</b>	2CLA227410N1802	5

#### Champagne

1-gang	1	<b>N2171.1 CV</b>	2CLA217110N1902	20
1-gang	2	<b>N2271.1 CV</b>	2CLA227110N1902	20
2-gang	2+2	<b>N2272.1 CV</b>	2CLA227210N1902	10
3-gang	2+2+2	<b>N2273.1 CV</b>	2CLA227310N1902	5
4-gang	2+2+2+2	<b>N2274.1 CV</b>	2CLA227410N1902	5

## Zenit Soul

### Frames

01



**4,1 mm height.**  
The essential frame with a ultra-light profile, being one of the slimmest frames in the market.

02



01 Side view, 4,1 x 85 mm  
1-gang cover frame suitable for European square and round boxes:

02 Frame 1-gang, 2 modules

3 to 7 module cover frames for 3, 4 and 7 module boxes horizontal installation habit (Italian)

03

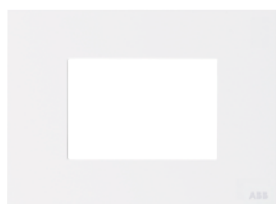

03 Frame 3 modules for 3 modules box

04 Frame 4 modules for 4 modules box

05 Frame 7 modules for 7 modules box

04

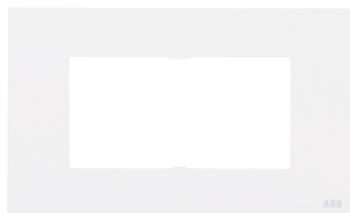

3 module cover frames for 3 module or 4"x2" box vertical installation habits (American)

06 Frame 3 modules in 3 modules box

05

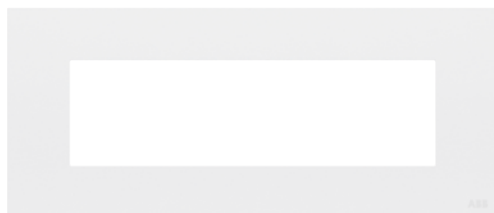

06

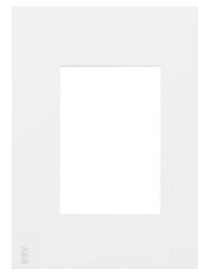

BL - White



PL - Silver



CB - White Glass

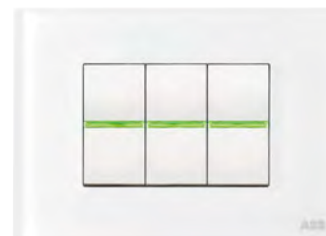

AN - Anthracite

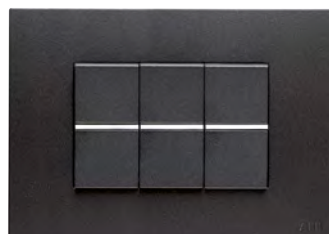

CV - Champagne



CN - Black Glass



## Zenit Soul - ABB logo

### Frames

Size	Modularity	Article-No.	Order-No.	Pack/Qty
------	------------	-------------	-----------	----------



#### Frames - 2, 3, 4 and 7 modules - Polycarbonate

Material: polycarbonate

Size (height x width):

- 2M: 85 x 85 mm.

- 3M: 117 x 85 mm.

- 4M: 139 x 85 mm.

- 7M: 205 x 85 mm.

Mounting plate codes:

- For 2M box (60 mm screw distance): Z2271.91.

- For 3M box (83,5 mm screw distance): Z2373.91.

- For 4M box (107 mm screw distance): Z2474.91.

- For 7M box (100 mm screw distance): Z2777.91.

Mounting box codes (flush / surface mounting):

- 2M: 1099, 1999 / 8591.

- 3M: 499.3 / N2993.

- 4M: 1499.4 / N2994.

- 7M: 1499.7 / -.

#### White

2M	2	<b>Z2271.1 BL</b>	2CLA227110Z1101	20
3M	3	<b>Z2373.1 BL</b>	2CLA237310Z1101	20
4M	4	<b>Z2474.1 BL</b>	2CLA247410Z1101	10
7M	7	<b>Z2777.1 BL</b>	2CLA277710Z1101	5

#### Silver

2M	2	<b>Z2271.1 BL</b>	2CLA227110Z1301	20
3M	3	<b>Z2373.1 BL</b>	2CLA237310Z1301	20
4M	4	<b>Z2474.1 BL</b>	2CLA247410Z1301	10
7M	7	<b>Z2777.1 BL</b>	2CLA277710Z1301	5

#### Anthracite

2M	2	<b>Z2271.1 BL</b>	2CLA227110Z1801	20
3M	3	<b>Z2373.1 BL</b>	2CLA237310Z1801	20
4M	4	<b>Z2474.1 BL</b>	2CLA247410Z1801	10
7M	7	<b>Z2777.1 BL</b>	2CLA277710Z1801	5

#### Champagne

2M	2	<b>Z2271.1 BL</b>	2CLA227110Z1901	20
3M	3	<b>Z2373.1 BL</b>	2CLA237310Z1901	20
4M	4	<b>Z2474.1 BL</b>	2CLA247410Z1901	10
7M	7	<b>Z2777.1 BL</b>	2CLA277710Z1901	5

Size	Modularity	Article-No.	Order-No.	Pack/Qty
------	------------	-------------	-----------	----------



#### Frames - 2, 3, 4 and 7 modules - Noble - Glass

Material: 1,1mm thickness glass

Size (height x width):

- 2M: 85 x 85 mm.

- 3M: 117 x 85 mm.

- 4M: 139 x 85 mm.

- 7M: 205 x 85 mm.

Mounting plate codes:

- For 2M box (60 mm screw distance): Z2271.91.

- For 3M box (83,5 mm screw distance): Z2373.91.

- For 4M box (107 mm screw distance): Z2474.91.

- For 7M box (100 mm screw distance): Z2777.91.

Mounting box codes (flush / surface mounting):

- 2M: 1099, 1999 / 8591.

- 3M: 499.3 / N2993.

- 4M: 1499.4 / N2994.

- 7M: 1499.7 / -.

#### White Glass

2M	2	<b>Z2271.1 CB</b>	2CLA227110Z3001	1
3M	3	<b>Z2373.1CB</b>	2CLA237310Z3001	1
4M	4	<b>Z2474.1 CB</b>	2CLA247410Z3001	1
7M	7	<b>Z2777.1 CB</b>	2CLA277710Z3001	1

#### Black Glass

2M	2	<b>Z2271.1 CN</b>	2CLA227110Z3101	1
3M	3	<b>Z2373.1 CN</b>	2CLA237310Z3101	1
4M	4	<b>Z2474.1 CN</b>	2CLA247410Z3101	1
7M	7	<b>Z2777.1 CN</b>	2CLA277710Z3101	1

## Zenit





### Selection table



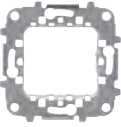
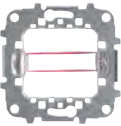

Installation habit / Size	Box			Zenit Float & Solid		Zenit Soul	
	Brick wall	Drywall	Surface	Mounting plate	Frame	Mounting plate	Frame
European							
1-gang	1x 1099	1x 999	1x 8591 BL	1x N2271.9 or 1x N2271.9G	1x N2171 or 1x N2271 or 1x N2271.1	1x Z2271.91	1x Z2271.1
2-gang	2x 1099	2x 999 or 1x 999.2	1x 8592 BL	2x N2271.9 or 2x N2271.9G or 1x N2272.9	1x N2272 or 1x N2272.1		
3-gang	3x 1099	3x 999	1x 8593 BL	3x N2271.9 or 3x N2271.9G or 1x N2273.9	1x N2273 or 1x N2273.1		
4-gang	4x 1099	4x 999		4x N2271.9 or 4x N2271.9G or 2x N2272.9	1x N2274 or 1x N2274.1		
5-gang	5x 1099	5x 999		5x N2271.9 or 5x N2271.9G or N2272.9 + N2273.9	1x N2275		
Italian / American							
3M	1x 499.3 or 1x 1SL0060A00		1x N2993 BL	1x N2473.9 or 1x N2371.9V	1x N2471/2/3 or 1x N2471/2/3.1/2/3 or 1x N2370/1/2/3.1	1x Z2373.91	1x Z2373.1
4M	1x 1499.4 or 1x 00 053		1x N2994 BL	1x N2474.9	1x N2474 or 1x N2374.1	1x Z2474.91	1x Z2474.1
7M	1x 1499.7			1x N2777.9	1x N2777 or 1x N2777.1	1x Z2777.91	1x Z2777.1
4"x4"				1x N2673.9	1x N2670/1/2/3		
Asian							
3"x3"				1x N2573.9	1x N2573		



## Zenit



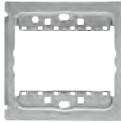

## Mounting plates for Float and Solid frames

Size	Modules	Article-No.	Order-No.	Pack/Qty
	<b>Mounting plate for European box</b> For horizontal and vertical installation. To be installed with frames code: N2171 and N227X. Mounting plate suitable for 60 mm screw distance boxes code: 1099, 1999 & 1999.2 or surface mounting boxes code: 8591, 8592 & 8593. With aligning flaps for multigang frames. Optional: elastic claws N2071.9.			
1-gang	2 modules	<b>N2271.9</b>	2CLA227190N1001	20
	<b>Mounting plate for European box with clamps</b> For horizontal and vertical installation. For horizontal and vertical installation. To be installed with frames code: N2171 and N227X. Mounting plate suitable for 60 mm screw distance boxes code: 1099, 1999 & 1999.2 or surface mounting boxes code: 8591, 8592 & 8593. With aligning flaps for multigang frames. Included: fixing claws.			
1-gang	2 modules	<b>N2271.9 G</b>	2CLA227110N1001	20
	<b>Mounting plate for European box</b> For horizontal installation. To be installed with frames code: - N2272: 1x N2272.9. - N2273: 1x N2272.9 + 1x N2271.9. - N2274: 2x N2272.9. - N2275: 2x N2272.9 + 1x N2271.9. Mounting plate suitable for 60 mm screw distance boxes code: 1099, 1999 & 1999.2 or surface mounting boxes code: 8592 & 8593. With aligning flaps for multigang frames.			
2-gang	2+2 modules	<b>N2272.9</b>	2CLA227290N1001	20
	<b>Mounting plate for European box</b> For horizontal installation. To be installed with frames code: - N2273: 1x N2273.9 - N2274: 1x N2273.9 + 1x N2271.9. - N2275: 1x N2273.9 + 1x N2272.9. Mounting plate suitable for 60 mm screw distance boxes code: 1099, 1999 & 1999.2 or surface mounting boxes code: 8592 & 8593. With aligning flaps for multigang frames.			
3-gang	2+2+2 modules	<b>N2273.9</b>	2CLA227390N1001	20
	<b>Mounting plate for 3 module box - Vertical</b> Mounting plate that facilitates the assembly of 1 and 2 module devices in vertical installations. To be installed with frames code: N2472, N2371.1V and N2372.1. Mounting plate suitable for 83,5 mm screw distance boxes code: 499.3 or surface mounting boxes code: N2993.			
3M	2 modules	<b>N2371.9V</b>	2CLA237190N1001	20
	<b>Mounting plate for 3 module box</b> For horizontal and vertical installation of 1, 2 or 3 module devices. To be installed with frames code: N2471, N2471.1, N2472, N2472.1, N2472.2,N N2472.3, N2473, N2473.1, N2370.1, N2371.1, N2372.1, N2372.2 and N2373.1. Mounting plate suitable for 83,5 mm screw distance boxes code: 499.3 or surface mounting boxes code: N2993.			
3M	3 modules	<b>N2473.9</b>	2CLA247390N1001	20



Size	Modules	Article-No.	Order-No.	Pack/Qty
	<b>Mounting plate for 4 module box</b> For horizontal and vertical installation of 1, 2 or 3 module devices. To be installed with frames code: N2474 and N2374.1. Mounting plate suitable for 107 mm screw distance boxes code: 1499.4 or surface mounting boxes code: N2994.			
4M	4 modules	<b>N2474.9</b>	2CLA247490N1001	20
	<b>Mounting plate for 7 module box</b> For horizontal and vertical installation of 1, 2 or 3 module devices. To be installed with frames code: N2777 and N2777.1. Mounting plate suitable for 100 mm screw distance boxes code: 1499.7.			
7M	7 modules	<b>N2777.9</b>	2CLA277790N1001	20
	<b>Mounting plate for 4"x4" box</b> For horizontal and vertical installation of 1, 2 or 3 module devices. To be installed with frames code: N2670, N2671.1, N2672.2, N2672.4 and N2673.6. Mounting plate suitable for 4"x4" boxes.			
4"x4"	3+3 modules	<b>N2673.9</b>	2CLA267390N1001	10
	<b>Mounting plate for BS 3"x3" box</b> For horizontal and vertical installation in square boxes of 1, 2 or 3 module devices. To be installed with frames code: N2573. Mounting plate suitable for 60,3 mm screw distance BS 3"x3" boxes.			
3"x3"	3 modules	<b>N2573.9</b>	2CLA257390N1001	20
	<b>Accessory for elastic claws</b> Accessory that facilitates the installation of 1 module devices in mounting plate N2271.9 with the elastic claws N2071.9.			
		<b>N2071.8</b>	2CLA207180N1001	10
	<b>Elastic claws</b> Fixing elastic claws for mounting plates code: N2271.9.			
		<b>N2071.9</b>	2CLA207190N1001	20

## Zenit

### Mounting plates for Soul frames





Size	Modules	Article-No.	Order-No.	Pack/Qty
		<b>Mounting plate for European box</b> For horizontal and vertical installation. To be installed with frames code: Z2271.1. Mounting plate suitable for 60 mm screw distance boxes code: 1099, 1999 & 1999.2 or surface mounting boxes code: 8591, 8592 & 8593. With aligning flaps for multigang frames.		
1-gang	2 modules	<b>Z2271.91</b>	2CLA227191Z1001	24
		<b>Mounting plate for 3 module box</b> For horizontal and vertical installation of 1, 2 or 3 module devices. To be installed with frames code: Z2373.1 Mounting plate suitable for 83,5 mm screw distance boxes code: 1SL0060A00. Included: 2 screws to fix the mounting plate.		
3M	3 modules	<b>Z2373.91</b>	2CLA2237391Z1001	20
		<b>Mounting plate for 4 module box</b> For horizontal and vertical installation of 1, 2 or 3 module devices. To be installed with frames code: Z2474.1. Mounting plate suitable for 107 mm screw distance boxes code: 00 053. Included: 2 screws to fix the mounting plate.		
4M	4 modules	<b>Z2474.91</b>	2CLA247491Z1001	20
		<b>Mounting plate for 7 module box</b> For horizontal and vertical installation of 1, 2 or 3 module devices. To be installed with frames code: Z2777.1. Mounting plate suitable for 100 mm screw distance boxes code: 1499.7. Included: 4 screws to fix the mounting plate.		
7M	7 modules	<b>Z2777.91</b>	2CLA277791Z1001	20

### Flush mounting boxes - European



Size	Modules	Article-No.	Order-No.	Pack/Qty
		<b>European type box - Bricks and cement</b> Installation box for walls built with bricks or cement. Distance between screws: 60 mm Suitable for mounting plates code: N2271.9, N2271.9G, N2272.9, N2273.9 & Z2271.91. Allows the input of 2 tubes per each side. Linkable for multigang frames. Included: 2 screws to fix the mounting plate. The screws can be placed in any of the 4 sides to facilitate the installation of the insert in vertical and horizontal.		
1-gang	2 modules	<b>1099</b>	2CLA009900A1001	50
		<b>European type box - Drywall and partitions</b> Installation box for walls built with drywall or partitions. Distance between screws: 60 mm Suitable for mounting plates code: N2271.9, N2271.9G, N2272.9, N2273.9 & Z2271.91. Linkable for multigang frames. Included: 2 screws to fix the mounting plate. Shaft diameter: 68 mm.		
1-gang	2 modules	<b>999</b>	2CLA099909A1001	25
		<b>European type box - Drywall and partitions</b> Double box suitable for 2-gang mounting plates. Installation box for walls built with drywall or partitions. Distance between screws: 60 mm Suitable for mounting plates code: N2271.9, N2271.9G & N2272.9. Included: 4 screws to fix the mounting plate. Shaft diameter: 68 mm. Distance between centers: 71 mm.		
2-gang	2+2 modules	<b>999.2</b>	2CLA099920A1001	10

## Zenit

### Flush mounting boxes - Rectangular

Size	Modules	Article-No.	Order-No.	Pack/Qty
 <p><b>3 module type box - Bricks and cement</b> Installation box for walls built with bricks or cement. Distance between screws: 83,5 mm. Suitable for mounting plates code: N2371.9 &amp; N2373.9. Included: 2 screws to fix the mounting plate.</p>				
3M	3 modules	<b>499.3</b>	2CLA049930A1001	25
 <p><b>3 module type box - Bricks and cement</b> Installation box for walls built with bricks or cement. Distance between screws: 83,5 mm. Suitable for mounting plates code: Z2373.91.</p>				
3M	3 modules	<b>1SL0060A00</b>	1SL0060A00	243
 <p><b>4 module type box - Bricks and cement</b> Installation box for walls built with bricks or cement. Distance between screws: 107 mm Suitable for mounting plates code: N2474.9. Included: 2 screws to fix the mounting plate.</p>				
4M	4 modules	<b>1499.4</b>	2CLA049940A1001	20
 <p><b>4 module type box - Bricks and cement</b> Installation box for walls built with bricks or cement. Distance between screws: 107 mm Suitable for mounting plates code: Z2474.91.</p>				
4M	4 modules	<b>00 053</b>	M000530000	150
 <p><b>7 module type box - Bricks and cement</b> Installation box for walls built with bricks or cement. Distance between screws: 100 mm Suitable for mounting plates code: N2777.9. Without screws. Included: 4 screws to fix the mounting plate.</p>				
7M	7 modules	<b>1499.7</b>	2CLA049970A1001	5

### Frames for metallic and plastic profiles

Size	Modules	Article-No.	Order-No.	Pack/Qty
 <p><b>Frame for metallic and plastic profiles</b> Frames suitable to be installed in reduced dimensions surfaces as plastic and metallic profiles or screens. For 1 module devices. Size (width x height): 32 x 68 mm. Shaft size (width x height): 26 x 50 mm.</p>				
1-gang	1 module	<b>N2671 BL</b>	2CLA267100N1101	10
1-gang	1 module	<b>N2671 PL</b>	2CLA267100N1301	10
1-gang	1 module	<b>N2671 AN</b>	2CLA267100N1801	10
1-gang	1 module	<b>N2671 CV</b>	2CLA267100N1901	10
 <p><b>Frame for metallic and plastic profiles</b> Frames suitable to be installed in reduced dimensions surfaces as plastic and metallic profiles or screens. For 1 module devices. Size (width x height): 32 x 126 mm. Shaft size (width x height): 26 x 108 mm.</p>				
2-gang	1+1 module	<b>N2671.2 BL</b>	2CLA267120N1101	5
2-gang	1+1 module	<b>N2671.2 PL</b>	2CLA267120N1301	5
2-gang	1+1 module	<b>N2671.2 AN</b>	2CLA267120N1801	5
2-gang	1+1 module	<b>N2671.2 CV</b>	2CLA267120N1901	5
 <p><b>Frame for metallic and plastic profiles</b> Frames suitable to be installed in reduced dimensions surfaces as plastic and metallic profiles or screens. For 1 and 2 module devices. Size (width x height): 54 x 68 mm. Shaft size (width x height): 49 x 50 mm.</p>				
1-gang	2 modules	<b>N2672 BL</b>	2CLA267200N1101	6
1-gang	2 modules	<b>N2672 PL</b>	2CLA267200N1301	6
1-gang	2 modules	<b>N2672 AN</b>	2CLA267200N1801	6
1-gang	2 modules	<b>N2672 CV</b>	2CLA267200N1901	6

### DIN-rail mounting plate

 <p><b>Adapter for DIN rail - 2M</b> Adapter that facilitates the intallation of Zenit devices up to 2 modules in switchboards on DIN rails. RAL 9010. Width: 53,5 mm.</p>				
1-gang	2 modules	<b>N2692 BL</b>	2CLA269200N1101	10

## All weather and surface solutions

Zenit boxes and frames for flush and surface mounting. Four options that cover any need in flush, surface and/or all weather installations.

### IP20 surface mounting boxes:

- 1-gang boxes with 2, 3 and 4 modules space.
- Protection degree: IP20.
- Color: White RAL 9010.
- Perfect solution for indoor surface installations combined with pipes and trunking systems.

### IP55 surface mounting boxes:

- 1, 2 and 3-gang boxes with 2, 3, 2+2 and 2+2+2 modules space.
- Protection degree: IP55.
- Color: Gray RAL 7035.
- The box has a cover with a transparent elastic membrane that allows direct control of the switch and a comfortable opening angle of 120°.

### IP40 surface mounting boxes:

- 1, 2 and 3-gang boxes with 2, 3, 2+2 and 2+2+2 modules space.
- Protection degree: IP40.
- Color: Gray RAL 7035.
- Perfect solution for indoor surface installations requiring a higher level of protection like parkings, industries, stadiums, etc.







### IP55 flush mounting frames:

- 1 and 2-gang boxes with 2, 3 and 2+2 modules space.
- Protection degree: IP55
- Color: White, Gray RAL 7035 and Anthracite
- The frame has a cover with a transparent elastic membrane that allows direct control of the switch and a comfortable opening angle of 120°.







## Zenit

## IP20 surface mounting boxes



Color	Article-No.	Order-No.	Pack/Qty
	<b>Surface mounting box with frame - 2 modules</b> Surface mounting box for 1 and 2 module devices. The box includes the clipping system to clasp inserts (no mounting plate necessary). Included: frame - 2 modules Size (Width x Height x Depth): 64 x 70 x 47 mm. Pre-cut areas in the 4 sides for N2999 adapters.		
White	<b>N2991.1 BL</b>	2CLA299110N1101	10
	<b>Surface mounting box - 2M</b> Surface mounting box for 1 and 2 module devices. Suitable for 2 module mounting plates N2271.9. Suitable for N2171 and N2271 frames. Size (Width x Height x Depth): 86 x 86 x 44 mm. Pre-cut areas in the 4 sides for N2999 adapters.		
White	<b>8591 BL</b>	2CLA859100N1101	6
	<b>Surface mounting box - 2+2M</b> Surface mounting box for 1 and 2 module devices. Suitable for 2 module mounting plates N2271.9. Suitable for N2272 frames. Size (Width x Height x Depth): 157 x 86 x 44 mm. Pre-cut areas in the 4 sides for N2999 adapters.		
White	<b>8592 BL</b>	2CLA859200N1101	5
	<b>Surface mounting box - 2+2+2M</b> Surface mounting box for 1 and 2 module devices. Suitable for 2 module mounting plates N2271.9. Suitable for N2273 frames. Size (Width x Height x Depth): 228 x 86 x 44 mm. Pre-cut areas in the 4 sides for N2999 adapters.		
White	<b>8593 BL</b>	2CLA859300N1101	1
	<b>Surface mounting box - 3M</b> Surface mounting box for 1, 2 or 3 module devices. Suitable for 3 module mounting plates N2371.9 and N2373.9. Suitable for N2471, N2472 and N2473 frames. Size (Width x Height x Depth): 107 x 85 x 44 mm. Pre-cut areas in the 4 sides for N2999 adapters.		
White	<b>N2993 BL</b>	2CLA299300N1101	10
	<b>Surface mounting box - 4M</b> Surface mounting box for 1, 2 or 3 module devices. Suitable for 4 module mounting plates N2374.9. Suitable for N2374 frames. Size (Width x Height x Depth): 139 x 85 x 44 mm. Pre-cut areas in the 4 sides for N2999 adapters.		
White	<b>N2994 BL</b>	2CLA299400N1101	5
	<b>Adapter for tubes/pipes</b> Adapter for tubes of Ø16, Ø20, Ø25. Suitable for surface mounting boxes code: N2991.1, 8591, 8592, 8593, N2993 and N2994.		
White	<b>N2999 BL</b>	2CLA299900N1101	10

## IP40 surface mounting boxes



Color	Article-No.	Order-No.	Pack/Qty
	<b>Surface mounting box - IP40 - 2 modules</b> Box for surface installation. 1-gang - 2 modules. For 1 or 2 module devices. Size (height x width x depth): 80 x 65 x 55 mm. Color: gray - RAL 7035. Protection degree: IP40 / IK06. Incoming with multi-diameter cone for tubes/cables max. Ø20. The box includes the clipping system to clasp inserts (no mounting plate, nor frame are necessary).		
Gray	<b>N3291.1</b>	2CLA329110N1101	10
	<b>Surface mounting box - IP40 - 2+2 modules</b> Box for surface installation. 2-gang - 2+2 modules. For 1 or 2 module devices. Size (height x width x depth): 80 x 130 x 55 mm Color: gray - RAL 7035. Protection degree: IP40 / IK06. Double incoming with multi-diameter cone for tubes/cables max. Ø20. The box includes the clipping system to clasp inserts (no mounting plate, nor frame are necessary).		
Gray	<b>N3292.1</b>	2CLA329210N1101	10
	<b>Surface mounting box - IP40 - 2+2+2 modules</b> Box for surface installation. 3-gang - 2+2+2 modules. For 1 or 2 module devices. Size (height x width x depth): 80 x 195 x 55 mm. Color: gray - RAL 7035. Protection degree: IP40 / IK06. Incoming with multi-diameter cone for tubes/cables max. Ø20. The box includes the clipping system to clasp inserts (no mounting plate, nor frame are necessary).		
Gray	<b>N3293.1</b>	2CLA329310N1101	5
	<b>Surface mounting box - IP40 - 3 modules</b> Box for surface installation. 1-gang - 3 modules. For 1, 2 or 3 module devices. Size (height x width x depth): 80 x 104 x 55 mm Color: gray - RAL 7035. Protection degree: IP40 / IK06. Incoming with multi-diameter cone for tubes/cables max. Ø20. The box includes the clipping system to clasp inserts (no mounting plate, nor frame are necessary).		
Gray	<b>N3391.1</b>	2CLA339110N1101	10

## Zenit

### IP55 flush mounting kits



Color	Article-No.	Order-No.	Pack/Qty
	<b>Kit IP55 2-way switch - flush mounted</b> Kit with: - N3271 BL: IP55 frame for flush mounting - 1-gang - 2 modules. - N2202 BL: 1-gang, 2-way / 127 - 250 Vac / 16 AX. - 1-gang, 2 module mounting plate. Protection degree: IP55 (with lid closed). Color: white. Opening angle of the lid: 120°. The lid allows operating the switch in closed position.		
White	<b>N3002</b>	2CLA300200N1101	10
	<b>Kit IP55 push button - flush mounted</b> Kit with: - N3271 BL: IP55 frame for flush mounting - 1-gang - 2 modules. - N2204 BL: 1-gang, 1-way, NO push button / 127 - 250 Vac / 16 A. - 1-gang, 2 module mounting plate. Protection degree: IP55 (with lid closed). Color: white. Opening angle of the lid: 120°. The lid allows operating the push button in closed position.		
White	<b>N3004</b>	2CLA300400N1101	10
	<b>Kit IP55 Schuko socket outlet - flush mounted</b> Kit with: - N3271 BL: IP55 frame for flush mounting - 1-gang - 2 modules. - N2288 BL: Schuko socket outlet / 127 - 250 Vac / 16 A. - 1-gang, 2 module mounting plate. Protection degree: IP55 (with lid closed). Color: white. Opening angle of the lid: 120°.		
White	<b>N3088</b>	2CLA308800N1101	10

### IP55 flush mounting frames





Color	Article-No.	Order-No.	Pack/Qty
	<b>Flush mounting frames - IP55 - 2 modules</b> Frames for IP55 flush mounted installations. 1-gang - 2 modules. For 1 or 2 module devices. Size (height x width): 90 x 90 mm. Included: one 1-gang, 2 module mounting plate. Protection degree: IP55 (with lid closed). Opening angle of the lid: 120°. The lid allows operating the switch in closed position. Suitable for 60mm screw distance boxes.		
White	<b>N3271 BL</b>	2CLA327100N1101	10
Gray	<b>N3271 GR</b>	2CLA327100N1701	10
Anthracite	<b>N3271 AN</b>	2CLA327100N1801	10
	<b>Flush mounting frames - IP55 - 2+2 modules</b> Frames for IP55 flush mounted vertical and horizontal installations. 2-gang - 2+2 modules. For 1 or 2 module devices. Size (height x width): 161 x 90 mm. Included: two 1-gang, 2 module mounting plate. Protection degree: IP55 (with lid closed). Opening angle of the lid: 120°. The lid allows operating the switch in closed position. Suitable for 60mm screw distance boxes.		
White	<b>N3272 BL</b>	2CLA327200N1101	5
Gray	<b>N3272 GR</b>	2CLA327200N1701	5
Anthracite	<b>N3272 AN</b>	2CLA327200N1801	5
	<b>Flush mounting frames - IP55 - 3 modules</b> Frames for IP55 flush mounted horizontal installations. 1-gang - 3 modules. For 1, 2 or 3 module devices. Size (height x width): 90 x 122 mm. Included: one 1-gang, 3 module mounting plate. Protection degree: IP55 (with lid closed). Opening angle of the lid: 120°. The lid allows operating the switch in closed position. Suitable for 83,5mm screw distance 3 module boxes.		
White	<b>N3373 BL</b>	2CLA337300N1101	5
Gray	<b>N3373 GR</b>	2CLA337300N1701	5
Anthracite	<b>N3373 AN</b>	2CLA337300N1801	5

## Zenit

### IP55 surface mounting kits

Color	Article-No.	Order-No.	Pack/Qty
	<b>Kit IP55 2-way switch - surface mounted</b> Kit with: - N3291: IP55 box for surface mounting - 1-gang - 2 modules. - N2202 BL: 1-gang, 2-way / 127 - 250 Vac / 16 AX. Protection degree: IP55 (with lid closed). Color: white device / gray RAL 7035 box. Opening angle of the lid: 120°. The lid allows operating the switch in closed position. Incoming with multi-diameter cone for tubes/cables max. Ø20. The box includes the clipping system to clasp inserts (no mounting plate, nor frame are necessary).		
Gray	<b>N3202</b>	2CLA320200N1101	10
	<b>Kit IP55 push button - surface mounted</b> Kit with: - N3291: IP55 box for surface mounting - 1-gang - 2 modules. - N2204 BL: 1-gang, 1-way, NO push button / 127 - 250 Vac / 16 A. Protection degree: IP55 (with lid closed). Color: white device / gray RAL 7035 box. Opening angle of the lid: 120°. The lid allows operating the switch in closed position. Incoming with multi-diameter cone for tubes/cables max. Ø20. The box includes the clipping system to clasp inserts (no mounting plate, nor frame are necessary).		
Gray	<b>N3204</b>	2CLA300400N1101	10
	<b>Kit IP55 Schuko socket outlet - surface mounted</b> Kit with: - N3291: IP55 box for surface mounting - 1-gang - 2 modules. - N2288 BL: Schuko socket outlet / 127 - 250 Vac / 16 A. Protection degree: IP55 (with lid closed). Color: white device / gray RAL 7035 box. Opening angle of the lid: 120°. The lid allows operating the switch in closed position. Incoming with multi-diameter cone for tubes/cables max. Ø20. The box includes the clipping system to clasp inserts (no mounting plate, nor frame are necessary).		
Gray	<b>N3288</b>	2CLA308800N1101	10

### IP55 surface mounting boxes

Color	Article-No.	Order-No.	Pack/Qty
	<b>Surface mounting box - IP55 - 2 modules</b> Box for IP55 surface mounted installations. 1-gang - 2 modules. For 1 or 2 module devices. Size (height x width x depth): 80 x 65 x 63 mm Color: gray RAL 7035 Protection degree: IP55 (with lid closed). Opening angle of the lid: 120°. The lid allows operating the switch in closed position. Incoming with multi-diameter cone for tubes/cables max. Ø20. The box includes the clipping system to clasp inserts (no mounting plate, nor frame are necessary).		
Gray	<b>N3291</b>	2CLA329100N1101	10
	<b>Surface mounting box - IP55 - 2+2 modules</b> Box for IP55 surface mounted horizontal installations. 2-gang - 2+2 modules. For 1 or 2 module devices. Size (height x width x depth): 80 x 130 x 63 mm. Color: gray RAL 7035. Protection degree: IP55 (with lid closed). Opening angle of the lid: 120°. The lid allows operating the switch in closed position. Incoming with multi-diameter cone for tubes/cables max. Ø20. The box includes the clipping system to clasp inserts (no mounting plate, nor frame are necessary).		
Gray	<b>N3292</b>	2CLA329200N1101	10
	<b>Surface mounting box - IP55 - 2+2+2 modules</b> Box for IP55 surface mounted horizontal installations. 3-gang - 2+2+2 modules. For 1 or 2 module devices. Size (height x width x depth): 80 x 195 x 63 mm Color: gray RAL 7035 Protection degree: IP55 (with lid closed). Opening angle of the lid: 120°. The lid allows operating the switch in closed position. Incoming with multi-diameter cone for tubes/cables max. Ø20. The box includes the clipping system to clasp inserts (no mounting plate, nor frame are necessary).		
Gray	<b>N3293</b>	2CLA329300N1101	5
	<b>Surface mounting box - IP55 - 3 modules</b> Box for IP55 surface mounted horizontal installations. 1-gang - 3 modules. For 1, 2 or 3 module devices. Size (height x width x depth): 80 x 104 x 63 mm. Color: gray RAL 7035. Protection degree: IP55 (with lid closed). Opening angle of the lid: 120°. The lid allows operating the switch in closed position. Incoming with multi-diameter cone for tubes/cables max. Ø20. The box includes the clipping system to clasp inserts (no mounting plate, nor frame are necessary).		
Gray	<b>N3391</b>	2CLA339100N1101	10

---

## Zenit centralizations and workstations

Cutting-edge connectivity

---

Zenit centralizations and workstations is a complete range of electrical and multi-media connectivity systems that allow the electrification of both, spaces and furniture, with solutions for flush or surface installations. With all the guarantee and care design that you can expect from our brand, and with important advances to facilitate and make this type of installations more comfortable.







---

## Systems for centralized controls

The systems for centralized control of Zenit are oriented to respond to the needs generated in facilities of the tertiary sector (offices, shops, hotels, auditoriums, etc.). This system serves to centralize the control of different lights, blinds or equipment in a single box, in a single control point.

### **Better aesthetics outside, more comfort inside**

The Zenit control centralizations can be installed in both, surface and flush mounted boxes.

Plates with four finishes that perfectly combine with all the functionalities offered by Zenit:

- **BL:** White plate and trim.
- **BP:** White plate / Silver trim.
- **PL:** Silver plate and trim.
- **AN:** Anthracite plate and trim.

Also the surface boxes are available in the finishes White, Silver and Anthracite.

### **In most of the tertiary installations, a place to centralize the control of the various lights shutters, boilers, etc. is always required.**

The systems for centralized control of Zenit allows to group all these functions in a single box using the covers and inserts of **most complete modular range of the market: Zenit.**

With Zenit centralization systems **you can cover all the installation needs** that can arise in this type of premises, from the simplest up to the KNX functions (motion detection, thermostat, lighting control, blinds, etc.), as well as electronic functions as sound systems, dimming, door bell, room temperature control, timer, etc.



— Surface mounted box



— Flush mounted box



## Better aesthetics outside and greater comfort inside

Zenit systems for centralized controls allow you to integrate in a single system all functions that an installation may need. All this thanks to having the most complete modular range. A range of appreciated design and beautiful finishes that add value to the installations, with advanced functions that bring greater comfort and level of performance. With 1 module (N2100) or 2 module (N2200) inserts, you can distribute freely with 3 size options:

- **2-gang:** for 12 one module inserts or 6 two module inserts.
- **3-gang:** for 18 one module inserts or 9 two module inserts.
- **4-gang:** for 24 one module inserts or 12 two module inserts.

The Zenit systems for centralized controls, as well as Zenit Workstations, incorporate the renowned tilting system that simplifies the installation work to professionals. Allows each window to be tilted, opening it to the right or left. This greatly facilitates the work of connecting or exchanging the inserts, as it does not force you to work inside the box, but comfortably out of it. Once the connections have been made, with all the facilities offered by the Zenit modular inserts, it will be enough to replace the tilted window in its place by simply pressing on the end until you hear a "click". The tilting supports are made of metal to give to the centralization the maximum strength and resistance, and thus guarantee its durability over

time regardless of the number of times times it is necessary to change its configuration. Each window includes a comfortable and functional labeling area in its upper part that will allow the end user to identify the function associated to the insert on which it is located.



In addition, Zenit Centralizations offer all kinds of advantages to make the installation simpler and easier (adaptable to any type of wall, flush-mounted boxes with independent frames, systems of comfortable bonding, plates that are mounted by clipping ).



# Zenit systems for centralized controls

## Surface mounted centralizations



Surface mounted box with mounting plate + plate with trim + Zenit inserts

Selection table	12 modules	18 modules	24 modules
Surface mounting box	T1292 XX	T1293 XX	T1294 XX
Plate	T1272 XX	T1273 XX	T1274 XX
Insert	Zenit	Zenit	Zenit

## Flush mounted centralizations



Flush mounted box with mounting plate + plate with trim + Zenit inserts

Selection table	12 modules	18 modules	24 modules
Flush mounting box	T1092.1	T1093.1	T1094.1
Plate	T1272 XX	T1273 XX	T1274 XX
Inserts	Zenit	Zenit	Zenit

## Zenit - centralizations

### Surface mounting boxes

Color	Article-No.	Order-No.	Pack/Qty
-------	-------------	-----------	----------



#### Surface mounting box - 12 modules

Zenit centralization box for surface mounted installations.

2-gang - 6+6 modules.

For 1, 2 or 3 module devices.

Size (height x width x depth): 204 x 212 x 55 mm.

Included:

- Metallic mounting plates (horizontally folding for easy installation).

- Screws.

- Plugs.

Suitable for frames code: T1272.

White	<b>T1292 BL</b>	2CLA129200T1001	1
Silver	<b>T1292 PL</b>	2CLA129200T1301	1
Anthracite	<b>T1292 AN</b>	2CLA129200T1801	1



#### Surface mounting box - 18 modules

Zenit centralization box for surface mounted installations.

3-gang - 6+6+6 modules.

For 1, 2 or 3 module devices.

Size (height x width x depth): 275 x 212 x 55 mm

Included:

- Metallic mounting plates (horizontally folding for easy installation).

- Screws.

- Plugs.

Suitable for frames code: T1273.

White	<b>T1293 BL</b>	2CLA129300T1001	1
Silver	<b>T1293 PL</b>	2CLA129300T1301	1
Anthracite	<b>T1293 AN</b>	2CLA129300T1801	1



#### Surface mounting box - 24 modules

Zenit centralization box for surface mounted installations.

4-gang - 6+6+6+6 modules.

For 1, 2 or 3 module devices.

Size (height x width x depth): 346 x 212 x 55 mm

Included:

- Metallic mounting plates (horizontally folding for easy installation).

- Screws.

- Plugs.

Suitable for frames code: T1274.

White	<b>T1294 BL</b>	2CLA129400T1001	1
Silver	<b>T1294 PL</b>	2CLA129400T1301	1
Anthracite	<b>T1294 AN</b>	2CLA129400T1801	1

### Flush mounting boxes

Product	Article-No.	Order-No.	Pack/Qty
---------	-------------	-----------	----------

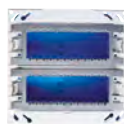

#### Flush mounting box - 12 modules

Zenit centralization box for flush mounted installations.

2-gang - 6+6 modules.

For 1, 2 or 3 module devices.

Size (height x width x depth): 178 x 186 x 55 mm

Included:

- Metallic mounting plates (horizontally folding for easy installation).

- multi-box linking accessories.

- Screws.

- Plugs.

- Claws for drywall.

Suitable for frames code: T1272.

<b>T1092.1</b>	2CLA109210T1001	1
----------------	-----------------	---



#### Flush mounting box - 18 modules

Zenit centralization box for flush mounted installations.

3-gang - 6+6+6 modules.

For 1, 2 or 3 module devices.

Size (height x width x depth): 249 x 186 x 55 mm

Included:

- Metallic mounting plates (horizontally folding for easy installation).

- multi-box linking accessories.

- Screws.

- Plugs.

- Claws for drywall.

Suitable for frames code: T1273.

<b>T1093.1</b>	2CLA109310T1001	1
----------------	-----------------	---



#### Flush mounting box - 24 modules

Zenit centralization box for flush mounted installations.

4-gang - 6+6+6+6 modules.

For 1, 2 or 3 module devices.

Size (height x width x depth): 320 x 186 x 55 mm

Included:

- Metallic mounting plates (horizontally folding for easy installation).

- multi-box linking accessories.

- Screws.

- Plugs.

- Claws for drywall.

Suitable for frames code: T1274.

<b>T1094.1</b>	2CLA109410T1001	1
----------------	-----------------	---

## Zenit - centralizations

### Frames

Color	Article-No.	Order-No.	Pack/Qty
-------	-------------	-----------	----------



#### Frame for centralizations - 12 modules

Color:

- BL: White plate / White frame.
- BP: White plate / Silver frame.
- PL: Silver plate / Silver frame.
- AN: Anthracite plate / Anthracite frame.

Zenit centralization frames for flush mounting boxes code T1092.1 and surface mounting boxes code T1292.

2-gang - 6+6 modules.

For 1, 2 or 3 module devices.

With labeling space.

Size (height x width): 204 x 212 mm.

White/White	<b>T1272 BL</b>	2CLA127200T1101	1
White/Silver	<b>T1272 BP</b>	2CLA127200T1201	1
Silver	<b>T1272 PL</b>	2CLA127200T1301	1
Anthracite	<b>T1272 AN</b>	2CLA127200T1801	1



#### Frame for centralizations - 18 modules

Color:

- BL: White plate / White frame.
- BP: White plate / Silver frame.
- PL: Silver plate / Silver frame.
- AN: Anthracite plate / Anthracite frame.

Zenit centralization frames for flush mounting boxes code T1093.1 and surface mounting boxes code T1293.

4-gang - 6+6+6 modules.

For 1, 2 or 3 module devices.

With labeling space.

Size (height x width): 275 x 212 mm.

White/White	<b>T1273 BL</b>	2CLA127300T1101	1
White/Silver	<b>T1273 BP</b>	2CLA127300T1201	1
Silver	<b>T1273 PL</b>	2CLA127300T1301	1
Anthracite	<b>T1273 AN</b>	2CLA127300T1801	1



#### Frame for centralizations - 24 modules

Color:

- BL: White plate / White frame.
- BP: White plate / Silver frame.
- PL: Silver plate / Silver frame.
- AN: Anthracite plate / Anthracite frame.

Zenit centralization frames for flush mounting boxes code T1094.1 and surface mounting boxes code T1294.

4-gang - 6+6+6+6 modules.

For 1, 2 or 3 module devices.

With labeling space.

Size (height x width): 346 x 212 mm.

White/White	<b>T1274 BL</b>	2CLA127400T1101	1
White/Silver	<b>T1274 BP</b>	2CLA127400T1201	1
Silver	<b>T1274 PL</b>	2CLA127400T1301	1
Anthracite	<b>T1274 AN</b>	2CLA127400T1801	1

## Systems for workstations

In an office the number of workplaces that require being connected to computers and multimedia equipment is increasing. This system makes it possible to group all together the needs of a working place (electrical outlets, telephone, data, protection and multimedia) in a single box.

### Solutions to simplify your work

Standard configuration including 4 double modules consisting of:

- 4 standard duplex Schuko socket outlets,
- 2 UPS duplex Schuko socket outlets,
- 1 quadruple adapter for telephone or data connectors

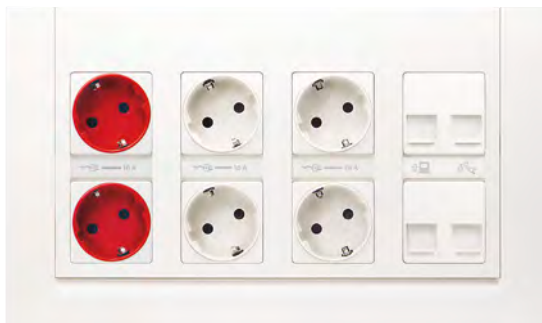

Special kit that incorporates standard mechanisms

### Finishes suiting to each workspace

The Zenit workstations are available in three finishes:

- **BL:** White plate and trim
- **PL:** Silver plate and trim
- **TT:** White plate / Titanium metallic trim

Also the surface boxes are available in the finishes White and Silver.





#### Professional solutions, solutions as a whole

The Zenit systems for workstations allow to group all the needs of a job in a single box, that can be:

- **Surface mounted box**, to be installed with pipe or trunking inlet.
- **Flush mounted box**, for brick walls or drywalls.
- **Floor box**, for traditional or concrete floors, as well as raised or technical floors.

With different options of measurement and capacity, **in order to provide the necessary flexibility in each workstation.**

**And the duplex inserts, for sockets, voice and data**, specially designed for these boxes, being the most used insert type in this kind of installations.

## The maximum simplicity and comfort in the installation

The Zenit workstations have been meticulously designed with innovative breakthroughs, devised to solve in the most comfortable, quick and easy way any installation.

- **1** In addition to the usual cutouts for the drill, the base has flexible flaps for a correct adaptation to non homogeneous, rough or imperfect walls. It is also equipped with holes arranged horizontally and vertically, to be able to level the box in both directions.
- **2** The bottom has a removable lid with several cutouts for different trunking dimensions.
- **3** Guides at the upper and lower ends facilitate the placement of a metal separator to avoid interferences between power and voice/data lines.

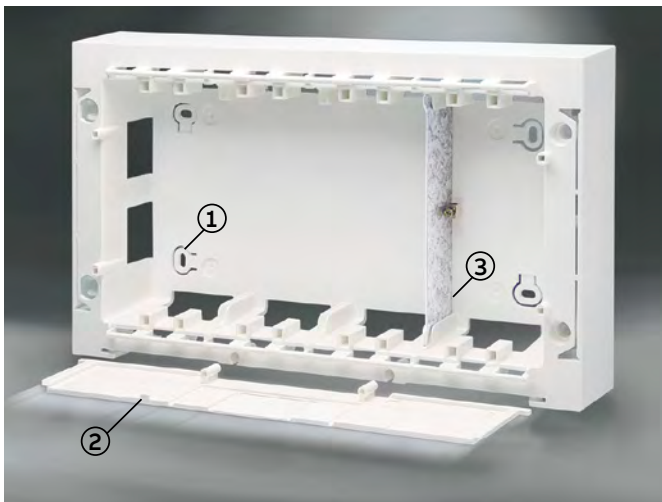

- At the rear the box has a large peripheral space to guide the cables comfortably.
- With multiple cable entries on all sides for easy access to all inserts.



The boxes are linked in a very simple way: the side is cut with scissors, the connection pieces that the box has inside are rotated and these are joined to the other box by simple pressure. This provides a perfect connection that does not alter the design of the box. (Figure 1).

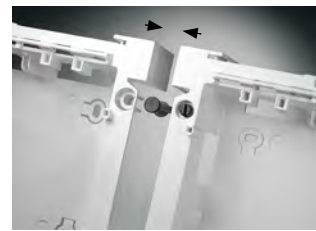

Figure 1



Figure 2

- To facilitate the alignment of the mounting plates, we include an accessory that joins and pairs the ends of the plates while screwing them. (Figure 2).

The boxes are linked very simply with two pieces that serve for the passage of the wiring and to keep them well aligned. (Figure 3).



Figure 3

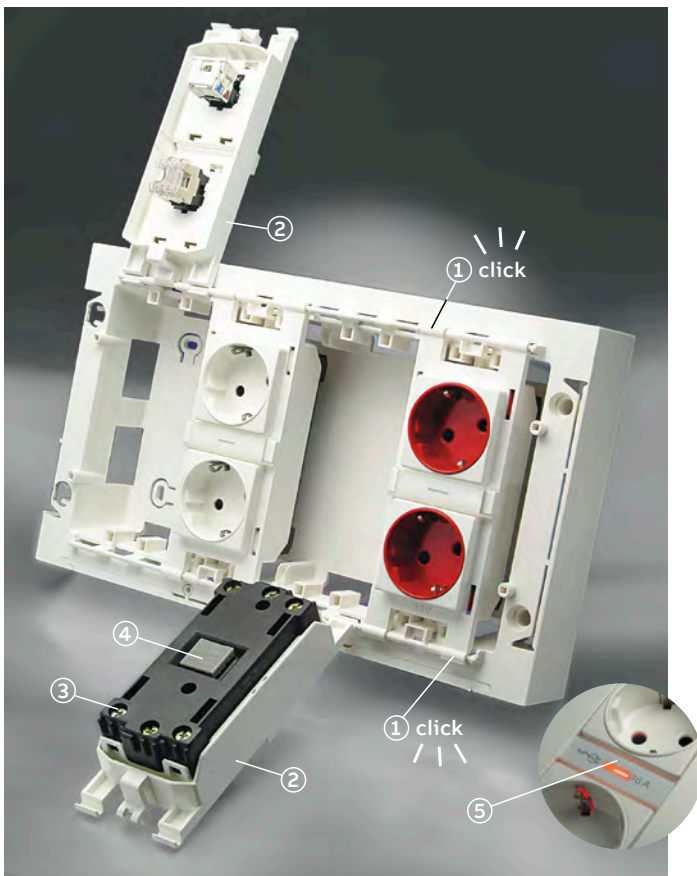

Figure 4

- The flush mounted box offers multiple tube or pipe inlets on all sides.
- It also has tabs that allow its correct adjustment in plasterboard partitions or drywalls. (Figure 4)

The mounting plate that holds the inserts is independent of the box. This offers two clear advantages to get a good finish without any problem:

- When screwing the mounting plate into the flush mounted box, the screw holes allow the frame to be rotated so that the frame is always straight, even if the flush-mounted box is not.
- In addition, the independent mounting plate rests on the wall and not on the box, which ensures that the outer bezel always fits well, even if the box is not perfectly scratched.



- **1** The embellishing cover and the frame (white or colored) are fixed by pressure, both to the mounting plate and to the box, without using any tool.
- **2** The frame offer easily removable slide-in tags that allow you to insert the labels included with the frame or any necessary description.
- **3** The socket outlets are positioned tilted to facilitate the use of bulky plugs or chargers.
- **4** In addition to the duplex inserts created especially for the workstations, the system has a double adapter that allows to incorporate any modular 1 or 2 module insert of the Zenit range.
- **5** The voice and data connectors are hidden behind a protective shutter that prevents dirt from entering them.

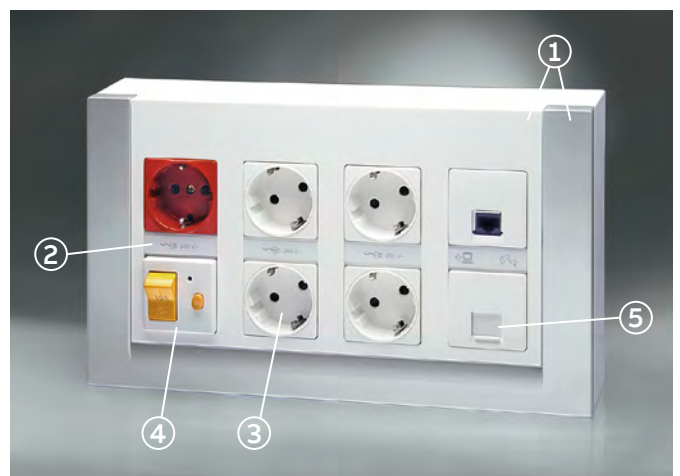

Thus, work is much easier

- **1** The inserts are installed by clipping, simply by pressing on the top and bottom of them.
- **2** The great advantage for the installation is that, in order to facilitate its connection as much as possible, the inserts swing very easily in both directions (up and down). This allows you to work comfortably outside the box and, once the connections have been finished, reposition them in place by clicking on the bracket.
- **3** The screws of the socket outlets are located at the rear for easier tightening. In addition in the duplex socket outlets it is only necessary to connect on one side, which reduces the time of wiring in half.
- **4** Thanks to this innovative tilting system, the voltage indicator lamp can also be easily replaced by pressure and without the need for additional cables or connections at the rear of the inserts.
- **5** When placing the lamp on a duplex Schuko socket outlet or a duplex French/earth-pin socket outlet the sign is illuminated, which allows to easily identify if there is power supply at that point.

# Zenit systems for workstations

Surface mounted workstations for walls and furniture



## Surface mounted box with mounting plate + plate with trim + inserts

Selection table	3 columns	4 columns	5 columns
Surface mounting box	T1193 XX	T1194 XX	T1195 XX
Plate	T1173 XX	T1174 XX	T1175 XX
Insert	T1088 XX, T1087, T1018.X	T1088 XX, T1087 RJ, T1018.X	T1088 XX, T1087 RJ, T1018.X
Fordable lid (optional)	T1173.5	T1174.5	T1175.5

Flush mounted workstations for walls and furniture



## Flush mounted box with mounting plate + plate with trim + inserts

Selection table	3 columns	4 columns
Flush mounting box	T1093	T1094
Plate	T1173 XX	T1174 XX
Insert	T1088 XX, T1087 RJ, T1018.X	T1088 XX, T1087 RJ, T1018.X
Fordable lid (optional)	T1173.5	T1174.5

# Zenit systems for workstations

Flush mounted workstations for floors

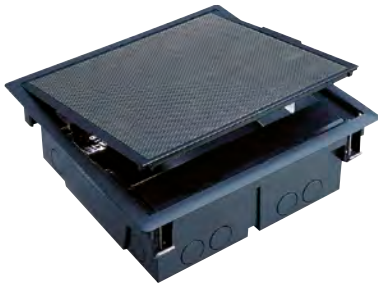

Floor box + plate with mounting plate + inserts

Selection table	3 columns
Floor box	T1393, T1393.1
Plate	T1373
Inserts	T1088 XX, T1087 RJ, T1018.X
Metal box for traditional/concrete floor (optional)	T1393.9

Application examples for workstations

- Workstation for wall or furniture
- Surface mounted
- With Zenit's MCB and RCD protection insert

Workstation with 4 columns (Silver) with 3 standard Schuko socket outlets, 2 red for UPS and one support for 4 data/telephone connectors.  
Composition:

- Workstation for wall or furniture
- Flush mounted
- With data and telephone connectors

Workstation with 3 columns (White) with fordable lid, 2 standard duplex Schuko socket outlets, 2 red for UPS, one telephone outlet and data outlet CAT5e UTP. Composition:

- Workstation for floor installation
- With Schuko socket outlets and data connectors

Workstation with 3 columns, 1 standard duplex Schuko socket outlet, 1 red for UPS, one telephone outlet and data outlet CAT6 FTP. Composition:

Description	Code
Surface mounting box with mounting plate Silver	T1194 PL
Plate with trim Silver	T1174 PL
Duplex Schuko socket outlet Silver	T1088 PL
Duplex Schuko socket outlet Silver-Red	T1088 RP
Support for 4 data/telephone connectors Silver	T1018.4 BL
Adaptor for Zenit modular inserts	T1000
Zenit Schuko socket outlet Silver	N2288 PL
Zenit MCB (10A)+ RCD (10mA) protection device Silver	N2234.2 PL

Description	Code
Flush mounting box with mounting plate	T1093
Plate with trim White	T1173 BL
Fordable lid	T1173.5
Duplex Schuko socket outlet White	T1088 BL
Duplex Schuko socket outlet Red	T1088 RJ
Adaptor for Zenit modular inserts	T1000
Zenit RJ12 telephone outlet	2017.2
Zenit RJ45 CAT5e UTP data outlet	2018.5
Zenit 1-gang cover plate for telephone and data outlets White	N2218.1 BL (2 units)

Description	Code
Floor box with stainless steel lid	T1393.1
Plate with mounting plate	T1373
Duplex Schuko socket outlet White	T1088 BL
Duplex Schuko socket outlet Red	T1088 RJ
Support for 2 data/telephone connectors Silver	T1018.2
Zenit RJ12 telephone outlet	2017.2
Zenit RJ45 CAT6 FTP data outlet	2018.6F

## Zenit - workstations

### Surface mounting boxes

Color	Article-No.	Order-No.	Pack/Qty
-------	-------------	-----------	----------



#### Surface mounting box - 3 columns

Zenit workstation box for surface mounted installations.  
3-columns - 2+2+2+2+2+2 modules.  
For 1 or 2 module devices. Also suitable for T10XX devices.  
Size (height x width x depth): 176 x 235 x 45 mm  
Included:  
- Mounting plates (vertically folding devices for easy installation).  
- Multi-box linking accessories.  
- Screws.  
- Plugs.  
- Side cover for trunking system incoming.  
- Isolating metallic plate to devide power from VDI.  
Suitable for frames code: T1173.

White	<b>T1193 BL</b>	2CLA119300T1001	1
Silver	<b>T1193 PL</b>	2CLA119300T1301	1



#### Surface mounting box - 4 columns

Zenit workstation box for surface mounted installations.  
4-columns - 2+2+2+2+2+2+2+2 modules.  
For 1 or 2 module devices. Also suitable for T10XX devices.  
Size (height x width x depth): 176 x 295 x 45 mm  
Included:  
- Mounting plates (vertically folding devices for easy installation).  
- Multi-box linking accessories.  
- Screws.  
- Plugs.  
- Side cover for trunking system incoming.  
- Isolating metallic plate to devide power from VDI.  
Suitable for frames code: T1174.

White	<b>T1194 BL</b>	2CLA119400T1001	1
Silver	<b>T1194 PL</b>	2CLA119400T1301	1



#### Surface mounting box - 5 columns

Zenit workstation box for surface mounted installations.  
5-columns - 2+2+2+2+2+2+2+2+2+2 modules.  
For 1 or 2 module devices. Also suitable for T10XX devices.  
Size (height x width x depth): 176 x 355 x 45 mm  
Included:  
- Mounting plates (vertically folding devices for easy installation).  
- Multi-box linking accessories.  
- Screws.  
- Plugs.  
- Side cover for trunking system incoming.  
- Isolating metallic plate to devide power from VDI.  
Suitable for frames code: T1175.

White	<b>T1195 BL</b>	2CLA119500T1001	1
Silver	<b>T1195 PL</b>	2CLA119500T1301	1

### Flush mounting boxes

Product	Article-No.	Order-No.	Pack/Qty
---------	-------------	-----------	----------

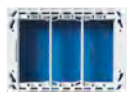

#### Flush mounting box - 3 columns

Zenit workstation box for flush mounted installations.  
3-columns - 2+2+2+2+2+2 modules.  
For 1 or 2 module devices. Also suitable for T10XX devices.  
Size (height x width x depth): 150 x 211 x 45 mm  
Included:  
- Mounting plates (vertically folding devices for easy installation).  
- Multi-box linking accessories.  
- Screws.  
- Plugs.  
- Isolating metallic plate to devide power from VDI.  
- Claws for drywall.  
Suitable for frames code: T1174.

	<b>T1093</b>	2CLA109300T1001	1
--	--------------	-----------------	---



#### Flush mounting box - 4 columns

Zenit workstation box for flush mounted installations.  
4-columns - 2+2+2+2+2+2+2+2 modules.  
For 1 or 2 module devices. Also suitable for T10XX devices.  
Size (height x width x depth): 150 x 271 x 45 mm  
Included:  
- Mounting plates (vertically folding devices for easy installation).  
- multi-box linking accessories.  
- Screws.  
- Plugs.  
- Isolating metallic plate to devide power from VDI.  
- Claws for drywall.  
Suitable for frames code: T1174.

	<b>T1094</b>	2CLA109400T1001	1
--	--------------	-----------------	---

## Zenit - workstations

### Frames

Color	Article-No.	Order-No.	Pack/Qty
 <p><b>Frame for workstations - 3 columns</b> Color: - BL: White plate / White frame - PL: Silver plate / Silver frame - TT: White plate / Titanium metallic frame Zenit workstation frames for flush mounting boxes code T1093 and surface mounting boxes code T1193. 3-columns - 6-gang - 2+2+2+2+2+2 modules. For 1 or 2 module devices. Also suitable for T10XX devices. Size (height x width): 176x 235 mm.</p>			
White	<b>T1173 BL</b>	2CLA117300T1101	1
Silver	<b>T1173 PL</b>	2CLA117300T1301	1

 <p><b>Frame for workstations - 4 columns</b> Color: - BL: White plate / White frame - PL: Silver plate / Silver frame - TT: White plate / Titanium metallic frame Zenit workstation frames for flush mounting boxes code T1094 and surface mounting boxes code T1194. 4-columns - 8-gang - 2+2+2+2+2+2+2+2 modules. For 1 or 2 module devices. Also suitable for T10XX devices. Size (height x width): 176x 295 mm.</p>			
White	<b>T1174 BL</b>	2CLA117400T1101	1
Silver	<b>T1174 PL</b>	2CLA117400T1301	1

 <p><b>Frame for workstations - 5 columns</b> Color: - BL: White plate / White frame - PL: Silver plate / Silver frame - TT: White plate / Titanium metallic frame Zenit workstation frames for surface mounting boxes code T1195. 5-columns - 10-gang - 2+2+2+2+2+2+2+2+2+2 modules. For 1 or 2 module devices. Also suitable for T10XX devices. Size (height x width): 176x 355 mm.</p>			
White	<b>T1175 BL</b>	2CLA117500T1101	1
Silver	<b>T1175 PL</b>	2CLA117500T1301	1

### Foldable lid

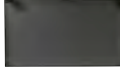
Color	Article-No.	Order-No.	Pack/Qty
 <p><b>Foldable lid for workstations - Black</b> Foldable lid to cover the devices and cables in a workstation: - T1173.5: for 3-column workstations. - T1174.5: for 4-column workstations. - T1175.5: for 5-column workstations. This is an optional accessory for surface and flush mounted boxes.</p>			
Black	<b>T1173.5</b>	2CLA117350T1001	1
Black	<b>T1174.5</b>	2CLA117450T1001	1
Black	<b>T1175.5</b>	2CLA117450T1001	1

## Zenit - workstations



### Floor boxes

Color	Article-No.	Order-No.	Pack/Qty
	<p><b>Floor box - 3 columns - 5 mm. hollow lid</b>            Floor box with 5 mm. deep hollow lid for carpet, linoleum, etc.            Protection degree:            - IP52 between the box and the floor ensured by loss-proof seal.            - IP4x at the rim of the lid.            - IP2x at the cable inlet.            Resistance of the lid: 1500 N according to DIN VDE 0364.            Resistance to chemicals present in the main detergents.            Direct installation in technical or raised floor.            Installation in traditional floors using the flush mounting metal box code T1393.9.            Color: dark gray RAL 7021.            Size (height x width x depth): 235 x 300 x 100 mm.            Slot size (height x width): 211 x 275 mm.            Suitable mounting plates code: T1373 and T1371.4.</p>		
Dark gray	<b>T1393</b>	M109020000	1

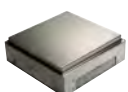
	<p><b>Floor box - 3 columns - Stainless steel lid</b>            Floor box with anti-slip square patterned lid with stainless steel finish.            Protection degree:            - IP52 between the box and the floor ensured by loss-proof seal.            - IP4x at the rim of the lid.            - IP2x at the cable inlet.            Resistance of the lid: 1500 N according to DIN VDE 0364.            Resistance to chemicals present in the main detergents.            Direct installation in technical or raised floor.            Installation in traditional floors using the flush mounting metal box code T1393.9.            Color: dark gray RAL 7021.            Size (height x width x depth): 235 x 300 x 100 mm.            Slot size (height x width): 211 x 275 mm.            Suitable mounting plates code: T1373 and T1371.4.</p>		
Dark gray	<b>T1393.1</b>	M109030000	1

	<p><b>Flush mounting metal box</b>            Accessory for the installation of the floor boxes code T1393 and T1393.1 in traditional/concrete floors.            Supplied with protection semi-lid and bunkheads for trunkings of 70x30 mm. and of 95x30 mm. and for ø 25 mm and 32 mm. conduits.            Size (height x width x depth): 230 x 305 x 105 mm.</p>		
	<b>T1393.9</b>	M109300000	1

### Mounting plates for floor box

Color	Article-No.	Order-No.	Pack/Qty
	<p><b>Mounting plate for floor box - 3 columns</b>            3-column adapter for the installation of Zenit devices and/or T10XX devices in floor boxes code: T1393 and T1393.1.            3-columns - 2+2+2+2+2 modules.            For 1 or 2 module devices. Also suitable for T10XX devices.            Included:            - Mounting plates.            - Frame.            - Screws.</p>		
White	<b>T1373</b>	2CLA137300T1101	20
	<p><b>Adapter plate for floor box - 4 modules</b>            4 module adapter plate for the installation of Zenit devices in floor boxes code: T1393 and T1393.1.            To be combined with Zenit 4-module mounting plates code N1374.9 and frames code N2374.1.            For 1, 2 or 3 module devices.            Included: screws.</p>		
Dark gray	<b>T1371.4</b>	M109190000	6

### Duplex socket outlets

	<p><b>Duplex Schuko socket outlet</b>            Rated voltage: 250 Vac.            Rated current: 16A.            Type F: 2P + E.            Shuttered for child safety.            Screw terminals (common terminal for both outlets).            Folding system for easy installation.            With labeling space.            Optional: power indicator LED lamp code: 6192.            Suitable for boxes code T1193, T1194, T1195, T1093 and T1094 and mounting plates code T1373.            Colors RJ and RP are suitable to identify special circuits.</p>		
White/White	<b>T1088 BL</b>	2CLA108800T1001	5
Silver/Silver	<b>T1088 PL</b>	2CLA108800T1301	5
White/Red	<b>T1088 RJ</b>	2CLA108800T7001	5
Silver/Red	<b>T1088 RP</b>	2CLA108800T7301	5
	<p><b>Duplex French/Earth-pin socket outlet</b>            Rated voltage: 250 Vac.            Rated current: 16A.            Type E: 2P + E.            Shuttered for child safety.            Screw terminals (common terminal for both outlets).            Folding system for easy installation.            With labeling space.            Optional: power indicator LED lamp code: 6192.            Suitable for boxes code T1193, T1194, T1195, T1093 and T1094 and mounting plates code T1373.            Color RJ is suitable to identify special circuits.</p>		
White/White	<b>T1087 BL</b>	2CLA108700T1001	5
White/Red	<b>T1087 RJ</b>	2CLA108700T7001	5





## Zenit - workstations

### Adapters

Color	Article-No.	Order-No.	Pack/Qty
	<b>2-gang plain outlet without shutter</b> 1-column plain outlet without shutter. 2-gang. With labeling space. Without shutters. Suitable for boxes code T1193, T1194, T1195, T1093 and T1094 and mounting plates code T1373. To be used with 2016, 2016.1, 2016.2 or 2016.3 connector adapters. Included: 2x 2016 connector adapters.		
White	<b>T1016.1 BL</b>	2CLA101610T1001	10
Silver	<b>T1016.1 PL</b>	2CLA101610T1301	10

	<b>4-gang plain outlet without shutter</b> 1-column plain outlet without shutter. 4-gang. With labeling space. Without shutters. Suitable for boxes code T1193, T1194, T1195, T1093 and T1094 and mounting plates code T1373. To be used with 2016, 2016.1, 2016.2 or 2016.3 connector adapters. Included: 4x 2016 connector adapters.		
White	<b>T1016.2 BL</b>	2CLA101620T1001	10
Silver	<b>T1016.2 PL</b>	2CLA101620T1301	10

	<b>2-gang 45° outlet with shutter</b> 1-column 45° outlet without shutter. 2-gang. With labeling space. With shutters. Suitable for boxes code T1193, T1194, T1195, T1093 and T1094 and mounting plates code T1373. To be used with 2016, 2016.1, 2016.2 or 2016.3 connector adapters. Included: 2x 2016 connector adapters.		
White	<b>T1016.7 BL</b>	2CLA101670T1001	5
Silver	<b>T1016.7 PL</b>	2CLA101670T1301	5

	<b>4-gang plain outlet with shutter</b> 1-column plain outlet without shutter. 4-gang. With labeling space. With shutters. Suitable for boxes code T1193, T1194, T1195, T1093 and T1094 and mounting plates code T1373. To be used with 2016, 2016.1, 2016.2 or 2016.3 connector adapters. Included: 4x 2016 connector adapters.		
White	<b>T1016.4 BL</b>	2CLA101640T1001	10
Silver	<b>T1016.4 PL</b>	2CLA101640T1301	10

	<b>2-gang 45° outlet without shutter</b> 1-column 45° outlet without shutter. 2-gang. With labeling space. Without shutters. Suitable for boxes code T1193, T1194, T1195, T1093 and T1094 and mounting plates code T1373. To be used with 2016, 2016.1, 2016.2 or 2016.3 connector adapters. Included: 2x 2016 connector adapters.		
White	<b>T1016.5 BL</b>	2CLA101650T1001	5
Silver	<b>T1016.5 PL</b>	2CLA101650T1301	5

Color	Article-No.	Order-No.	Pack/Qty
	<b>4-gang 45° outlet without shutter</b> 1-column 45° outlet without shutter. 4-gang. With labeling space. Without shutters. Suitable for boxes code T1193, T1194, T1195, T1093 and T1094 and mounting plates code T1373. To be used with 2016, 2016.1, 2016.2 or 2016.3 connector adapters. Included: 4x 2016 connector adapters.		
White	<b>T1016.6 BL</b>	2CLA101660T1001	5
Silver	<b>T1016.6 PL</b>	2CLA101660T1301	5

	<b>2-gang plain outlet with shutter</b> 1-column plain outlet without shutter. 2-gang. With labeling space. With shutters. Suitable for boxes code T1193, T1194, T1195, T1093 and T1094 and mounting plates code T1373. To be used with 2016, 2016.1, 2016.2 or 2016.3 connector adapters. Included: 2x 2016 connector adapters.		
White	<b>T1016.3 BL</b>	2CLA101630T1001	10
Silver	<b>T1016.3 PL</b>	2CLA101630T1301	10

	<b>4-gang 45° outlet with shutter</b> 1-column 45° outlet without shutter. 4-gang. With labeling space. With shutters. Suitable for boxes code T1193, T1194, T1195, T1093 and T1094 and mounting plates code T1373. To be used with 2016, 2016.1, 2016.2 or 2016.3 connector adapters. Included: 4x 2016 connector adapters.		
White	<b>T1016.8 BL</b>	2CLA101680T1001	10
Silver	<b>T1016.8 PL</b>	2CLA101680T1301	10

	<b>Adapter plate for ABB DIN-rail devices</b> 1-column adapter ABB System Pro M DIN-rail devices. 2 modules. For 1 or 2 module devices. Suitable for boxes code T1193, T1194, T1195, T1093 and T1094 and mounting plates code T1373.		
White	<b>T1034 BL</b>	2CLA103400T1001	10
Silver	<b>T1034 PL</b>	2CLA103400T1301	10

	<b>Adapter plate for Zenit devices</b> 1-column adapter plate for Zenit devices. 2+2 modules. For 1 or 2 module devices. With labeling space. Suitable for boxes code T1193, T1194, T1195, T1093 and T1094 and mounting plates code T1373.		
	<b>T1000</b>	2CLA100000T1001	10

---

## Sound system

A soundtrack in each space

---

Improve the sound of all your projects. The first sound system that adapts to the current way of listening to music and radio. With Bluetooth and USB input to connect it to your mobile devices, and with Multiroom function to hear one melody in each space or the same in all rooms. Zenit sound system is an innovative solution that thanks to its many advantages you can offer your customers to increase the value of your facilities. With the quality of ABB you already know and with a very simple installation that does not require work.





---

# Music from any device

Each person has his own musical universe. A compilation of artists that accompanies us on the smartphone, tablet, computer or even in the “cloud” or a streaming system. Zenit sound system is a door so that each person can access their musical universe from each room of their home or their work, in a simple way and with the maximum quality of sound.

**Compatible with the main operating systems as iOS, Android, Windows Phone, Mac OS, Windows...**

Zenit sound system also offers the possibility to listen to music from streaming platforms like Spotify, Google Play Music, Apple Music, Amazon Music Unlimited, Napster... or any online streaming music or radio provider.



**Bluetooth and USB:** it allows you to control the music from a smartphone or tablet via Bluetooth or play the music stored in USB devices.

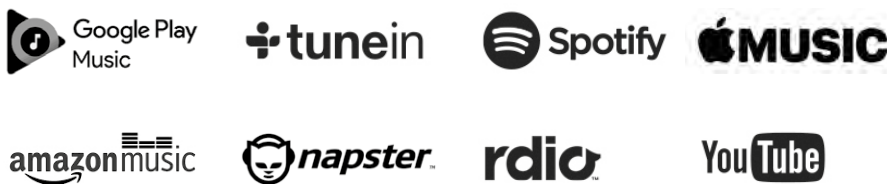

---

# Multiroom

A different music in each room or the same in all the rooms, it's your choice.

**The installation allows to control what music is heard in each room**, personalizing it in each case. In this way a person can listen to rock in the room, while in the kitchen classical music sounds. And the same in the workspaces, since in each office or meeting room you can tune in different music. But at any time you can play the same music in all spaces equipped with Zenit sound system, thanks to the multiroom function.

**Brings innovation to your home**  
It offers the sound quality of ABB in a device that will allow your customers to listen to a different music in each room. In addition, its **avant-garde design** makes Zenit sound system the perfect ally of the decoration in any space.

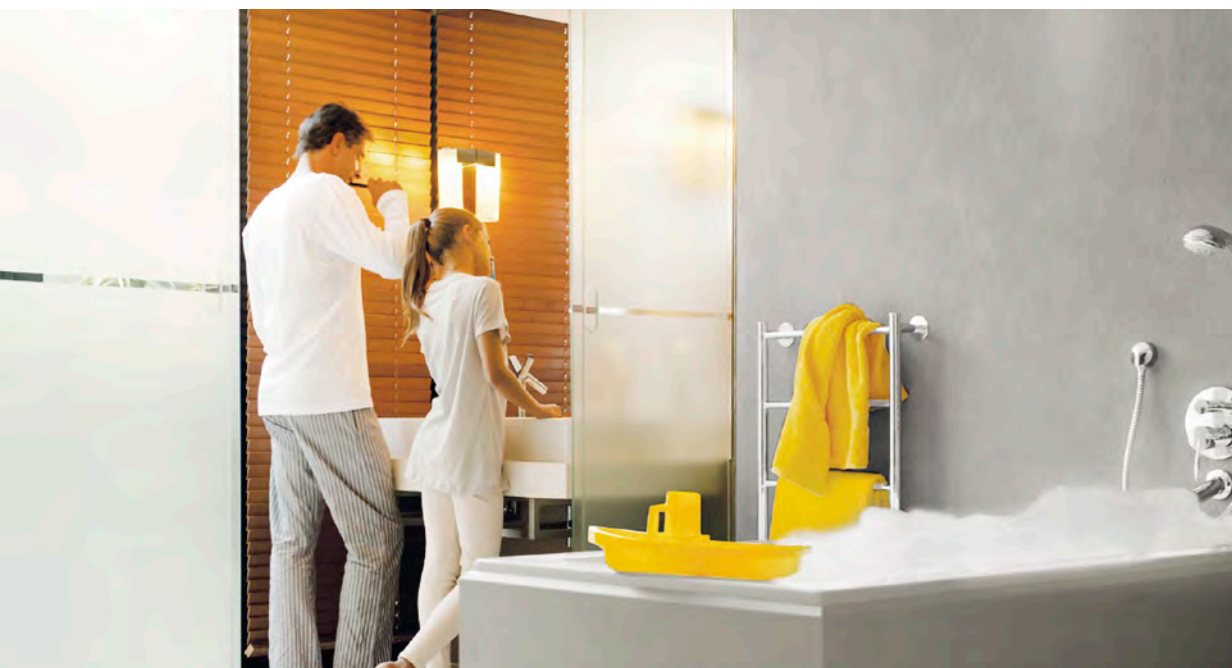

---

## Ease in your projects

Easy installation. To enjoy the Zenith sound system you will not have to do work, because it is installed just like a switch, you only need a hole with a power supply.

Whether it is a new installation or a refurbishment, the Zenit sound system can be installed very simply. When using the ceiling module, to enjoy its FM radio or Bluetooth connection functionality no additional wiring to the power supply is required, since the communication between the ceiling module and the wall mounted remote control is wireless.



---

## Also in the renovation

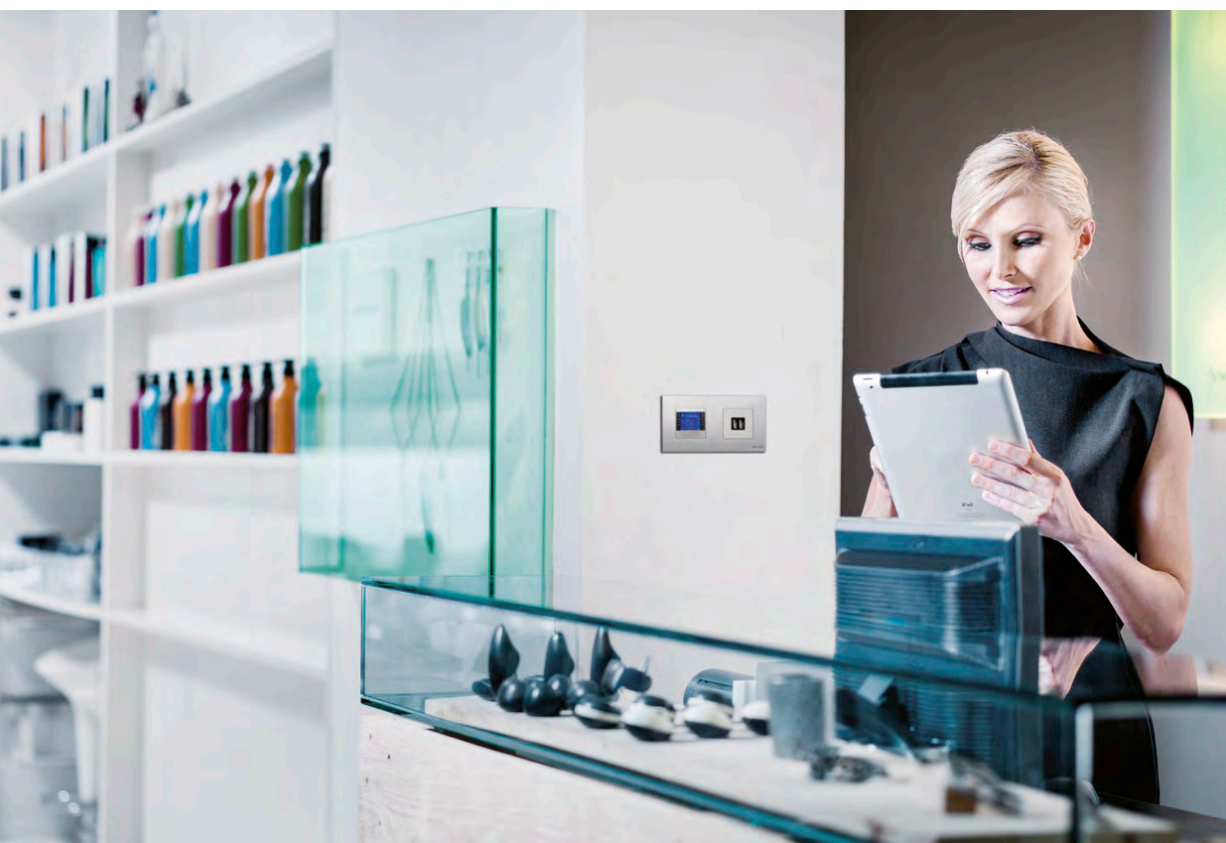

It adapts to the needs of each space. If you already have an old sound system from ABB or another brand, you can replace the old controls with the new modules of the Zenit sound system and continue using the speakers already installed. You will not need to have more holes in the wall than the existing ones, you can use those of the controls of your old sound system.

If you do not have a sound system, you can easily install a remote control on the wall taking advantage of any point where you have two standard 1-gang switches of ABB. These two 1-gang switches can be changed by a 2-gang switch mounted in a single 1-gang box and occupy the other 1-gang box that remains free with the remote control of the Zenit sound system. Now only one or several 5 "loudspeakers (up to 4 loudspeakers per channel) have to be installed in the ceiling and, taking advantage of the hole created for the loudspeakers, housing the ceiling module next to the module.





## Zenit - Sound system

### Multiroom Bluetooth system

Product	Article-No.	Order-No.	Pack/Qty
	<b>Multiroom sound module</b> Rated voltage: 127-230 Vac ± 15%; 50-60 Hz. Max. consumption: 200 mA. Stand-by consumption: 0,3W. Amplifier power: 6+6 W; <1% distortion (4 Ω). Speaker impedance: 4 Ω (2+2 W audio). FM radio digital tuner with RDS. Alarm clock with buzzer, radio types and snooze function. Bluetooth receiver: Bluetooth® v2.1 2.4GHz IEEE 802.15.1. Multiroom function available (1 master device and up to 14 slave devices). Remote control using code 9368.2 (ZigBee 2.4GHz IEEE 802.15.4). Optional: auxiliary module 9368.3 for I/O (1 mini-jack stereo input & 1 mini-jack stereo output) and USB connection functions.		
	<b>9368.1</b>	2CLA936810A1001	1
	<b>Remote control for multiroom sound module - 2M</b> Rated voltage: 127-230 Vac ± 15%; 50-60 Hz. Max. consumption: 15 mA. Stand-by consumption: 0,5W. To control 9368.1 module (1 remote control for each module). Wireless connection between moles 9368.1 and 9368.2 (ZigBee 2.4GHz IEEE 802.15.4). Optional: auxiliary module 9368.3 for I/O (1 mini-jack stereo input & 1 mini-jack stereo output) and USB connection functions. In case of using 9368.3 module, the connection between modules 9368.1 and 9368.2 must be wired (3 wires). Mounting grid delivered with the cover plate (without fixing claws). Cover plate code: N2268.		
	<b>9368.2</b>	2CLA936820A1001	1
	<b>Cover plate for radio/remote control modules</b> Cover plate for FM-radio module and for remote control module code: 9368, 9368.2 & 9368.7.		
White	<b>N2268 BL</b>	2CLA226800N1101	1
Silver	<b>N2268 PL</b>	2CLA226800N1301	1
Anthracite	<b>N2268 AN</b>	2CLA226800N1801	1
Champagne	<b>N2268 CV</b>	2CLA226800N1901	1

### FM radio with alarm

Product	Article-No.	Order-No.	Pack/Qty
	<b>FM-radio and alarm module - 2M</b> Rated voltage: 230 Vac ± 15%; 50-60 Hz. Max. consumption: 100 mA. Stand-by consumption: 0,2W. Amplifier power: 2+2 W; <1% distortion (16 Ω). Speaker impedance: 16 Ω (2+2 W audio). FM radio digital tuner with RDS. Alarm clock with buzzer, radio types and snooze function. Optional: auxiliary module 9368.3 for I/O (1 mini-jack stereo input & 1 mini-jack stereo output), USB connection and Bluetooth receiver functions. Mounting grid delivered with the cover plate (without fixing claws). Cover plate code: N2268.		
	<b>9368</b>	2CLA936800A1001	1
	<b>FM-radio and alarm module - 2M</b> Rated voltage: 127 Vac ± 15%; 50-60 Hz. Max. consumption: 100 mA. Stand-by consumption: 0,2W. Amplifier power: 2+2 W; <1% distortion (16 Ω). Speaker impedance: 16 Ω (2+2 W audio). FM radio digital tuner with RDS. Alarm clock with buzzer, radio types and snooze function. Optional: auxiliary module 9368.3 for I/O (1 mini-jack stereo input & 1 mini-jack stereo output), USB connection and Bluetooth receiver functions. Mounting grid delivered with the cover plate (without fixing claws). Cover plate code: N2268.		
	<b>9368.7</b>	2CLA936870A1001	1
	<b>Cover plate for radio/remote control modules</b> Cover plate for FM-radio module and for remote control module code: 9368, 9368.2 & 9368.7.		
White	<b>N2268 BL</b>	2CLA226800N1101	1
Silver	<b>N2268 PL</b>	2CLA226800N1301	1
Anthracite	<b>N2268 AN</b>	2CLA226800N1801	1
Champagne	<b>N2268 CV</b>	2CLA226800N1901	1



## Zenit - Sound system

### Auxiliary module

Product	Article-No.	Order-No.	Pack/Qty
 <p><b>Auxiliary module - 2M</b>            Power supply through 9368, 9368.2 or 9368.7 modules.            Max. consumption: 200 mA.            Stand-by consumption: 0,4W.            Bluetooth receiver: Bluetooth® v2.1 2.4GHz IEEE 802.15.1.            USB connector: for MP3 and WAV files. Max. consumption of the connected device: 100 mA @5Vdc.            Input: 1x mini-jack stereo 3,5 mm.            Output: 1x mini-jack stereo 3,5 mm.            Mounting grid delivered with the cover plate (without fixing claws).            Cover plate code: N2268.3.</p>	<b>9368.3</b>	2CLA936830A1001	1

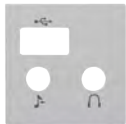

#### Cover plate for I/O + USB + Bluetooth module

Cover plate for I/O + USB + Bluetooth module code: 9368.3.

White	<b>N2268.3 BL</b>	2CLA226830N1101	1
Silver	<b>N2268.3 PL</b>	2CLA226830N1301	1
Anthracite	<b>N2268.3 AN</b>	2CLA226830N1801	1
Champagne	<b>N2268.3 CV</b>	2CLA226830N1901	1

### Bluetooth audio module

Color	Article-No.	Order-No.	Pack/Qty
 <p><b>Bluetooth sound module - 2M</b>            Rated voltage: 110-230 Vac <math>\pm</math> 15%; 50-60 Hz            Max. consumption: 7W            Stand-by consumption: 0,2W            Amplifier power: 2+2 W; &lt;1% distortion (16 <math>\Omega</math>)            Speaker impedance: 16 <math>\Omega</math> (2+2 W audio)            Audio inputs:            - Bluetooth: stereo Bluetooth® 4 version receiver with A2DP-SINK profile and memory for 8 links.            - Front input (AUX): 1x mini-jack stereo 3,5 mm.            - Rear input (TV): screw type terminal with 3 contacts (stereo).            Mounting grid delivered with the cover plate (without fixing claws).            Cover plate code: N2268.4</p>	<b>9368.4</b>	2CLA936840A1001	1



#### Cover plate for Bluetooth sound module

Cover plate for Bluetooth sound module code: 9368.4.

White	<b>N2268.4 BL</b>	2CLA226840N1101	1
Silver	<b>N2268.4 PL</b>	2CLA226840N1301	1
Anthracite	<b>N2268.4 AN</b>	2CLA226840N1801	1
Champagne	<b>N2268.4 CV</b>	2CLA226840N1901	1

## Zenit - Sound system

### Auxiliary amplifier

Product	Article-No.	Order-No.	Pack/Qty
 <p><b>Auxiliary 20W amplifier</b>            Rated voltage: 230 Vac <math>\pm</math> 10 % / 50-60 Hz.            Power consumption: 3,5 VA (max. 36 VA).            Output voltage: 15 V- (max. 1,5 A).            Output power:            - 10 + 10 W (2 <math>\Omega</math>).            - 20 W (4 <math>\Omega</math>).            Speaker impedance:            - 2 - 16 <math>\Omega</math> (10 + 10 W).            - 4 - 16 <math>\Omega</math> (20 W).            Can be operated in booster mode with FM radio modules 9368 and 9368.7 and multiroom modules 9368.1.            Can be operated in ""standalone"" mode with one audio input.            Can be used in bridge operation.            For extending the number of speakers at one amplifier insert.            For max. 16 speakers code 9329 or 9329.1.            DIN-rail installation. Module width: 7.</p>	<b>9335.1</b>	2CLA933510A1001	1

### Speaker connection unit

Product	Article-No.	Order-No.	Pack/Qty
 <p><b>Speaker connection unit - 2M</b>            Front: 2x spring speaker terminals (Red/Black).            Rear: 2x screw terminals.</p>	<b>N2257.1 BL</b>	2CLA225710N1101	1
	<b>N2257.1 PL</b>	2CLA225710N1301	1
	<b>N2257.1 AN</b>	2CLA225710N1801	1
	<b>N2257.1 CV</b>	2CLA225710N1901	1

### XLR connection unit

Product	Article-No.	Order-No.	Pack/Qty
 <p><b>Speaker connection unit - 2M</b>            Front: 2x spring speaker terminals (Red/Black).            Rear: 2x screw terminals.</p>	<b>N2255.1 BL</b>	2CLA225510N1101	1
	<b>N2255.1 PL</b>	2CLA225510N1301	1
	<b>N2255.1 AN</b>	2CLA225510N1801	1
	<b>N2255.1 CV</b>	2CLA225510N1901	1

### 2" loudspeaker for wall





Product	Article-No.	Order-No.	Pack/Qty
 <p><b>2" loudspeaker 2 W</b>            Compatible with sound modules and amplifier code: 9368, 9368.1, 9368.4, 9368.7 and 9335.1.            With broadband characteristics.            With screwless terminals.            Rated output: 2 W (RMS).            Frequency response: 150 - 16.000 Hz.            Impedance: 16 Ohm.            Mounting depth: 34 mm.            Without fixing claws.            Cover plate code: N2229, 8629 &amp; 9399.4.</p>	<b>9329</b>	2CLA932900A1001	1



Product	Article-No.	Order-No.	Pack/Qty
 <p><b>Cover plate for 2" loudspeaker</b>            Cover plate for 2" loudspeaker code: 9329.</p>	<b>N2229 BL</b>	2CLA222900N1101	5
	<b>N2229 PL</b>	2CLA222900N1301	5
	<b>N2229 AN</b>	2CLA222900N1801	5
	<b>N2229 CV</b>	2CLA222900N1901	5

Product	Article-No.	Order-No.	Pack/Qty
 <p><b>Embellishing grid for 2" loudspeaker</b>            Embellishing grid for 2" loudspeaker code: 9329.            Plastic material.</p>	<b>9399.4 BA</b>	2CLA939940A1001	5
	<b>9399.4 NG</b>	2CLA939940A1501	5

## Zenit - Sound system

### Loudspeakers for ceiling

Product	Article-No.	Order-No.	Pack/Qty
 <p><b>5" loudspeaker 6 W</b> Compatible with sound modules and amplifier code: 9368, 9368.1, 9368.4, 9368.7 and 9335.1. With broadband characteristics. With screw terminals. Rated output: 6 W (RMS). Frequency response: 70 - 10.000 Hz. Impedance: 16 Ohm. Flush mounted installation with 9399 mounting box or 9399.1 mounting ring. Embellishing grid code: 9399.2.</p>	<b>9329.1</b>	2CLA932910A1001	1
 <p><b>Installation box for 5" loudspeaker</b> For 9329.1 loudspeaker. For flush-mounted assembly. Drilling measurements: 174 mm. Mounting depth: 84 mm.</p>	<b>9399</b>	2CLA939900A1001	12
 <p><b>Installation ring for 5" loudspeaker</b> For 9329.1 loudspeaker. For mounting in hollow walls/ceilings. With spring brackets. Drilling measurements: 160 mm. Mounting depth: 110 mm.</p>	<b>9399.1</b>	2CLA939910A1001	12
 <p><b>Embellishing grid for 5" loudspeaker</b> Embellishing grid for 5" loudspeaker code: 9329.1. Plastic material. With central fixation screw.</p>	<b>9399.2</b>	2CLA939920A1001	12

Product	Article-No.	Order-No.	Pack/Qty
 <p><b>HiFi built-in ceiling loudspeaker - 5"</b> Compatible with sound modules and amplifier code: 9368, 9368.1, 9368.4, 9368.7 and 9335.1. 2-way system. For mounting in hollow walls/ceilings. With spring brackets. In corrosion-resistant metal design. With integrated loudspeaker grid. With screwless terminals. Nominal power: 30 W Frequency response: 50 - 20.000 Hz Impedance: 8 Ohm Drilling measurements: 165 mm. Mounting depth: 72 mm.</p>	<b>8226/10 EB</b>	2CKA008200A0202	1
 <p><b>Built-in ceiling loudspeaker - 5"</b> Compatible with sound modules and amplifier code: 9368, 9368.1, 9368.4, 9368.7 and 9335.1. With broadband characteristics. For mounting in hollow walls/ceilings. With spring brackets. In corrosion-resistant metal design. With integrated loudspeaker grid. With screwless terminals. Nominal power: 30 W Frequency response: 50 - 20.000 Hz Impedance: 8 Ohm Drilling measurements: 165 mm Mounting depth: 72 mm</p>	<b>8226 EB</b>	2CKA008200A0201	1
 <p><b>Built-in ceiling loudspeaker - 3"</b> Compatible with sound modules and amplifier code: 9368, 9368.1, 9368.4, 9368.7 and 9335.1. With broadband characteristics. For mounting in hollow walls/ceilings. With spring brackets. In corrosion-resistant metal design. With integrated loudspeaker grid. With screwless terminals. Nominal power: 10 W Frequency response: 90 - 20.000 Hz Impedance: 8 Ohm Drilling measurements: 90 mm Mounting depth: 38 mm</p>	<b>8225 EB</b>	2CKA008200A0200	1

---

## **Zenit & ABB-free@home®**

Making home automation easier than ever

Smart. ABB-free@home® transforms the house or the apartment into an intelligent home. Whether blinds, lights, heating, air conditioning, door communication or scenes. Easy to remote control via a switch on the wall, with the laptop or with the smartphone. Very convenient. Extremely comfortable. Very energy efficient. Especially attractive: Only minimal costs are involved when compared with conventional electrical installations.



—  
FREEDOM

# Home becomes smart





---

## Just as you like it

### The Smart Home

The perfect daily routine. With ABB-free@home<sup>®</sup> and Zenit, the entire home can be controlled not only with switches, but now even more practically: by smartphone or tablet and via touch or voice control. This allows home automation to be managed in a way that's mobile and smart, precise and flexible. For example, if the light atmosphere needs to be changed, tapping on the touchscreen or a simple voice command moves the blinds or changes the colours of the lights. Experience the future of smart living today.

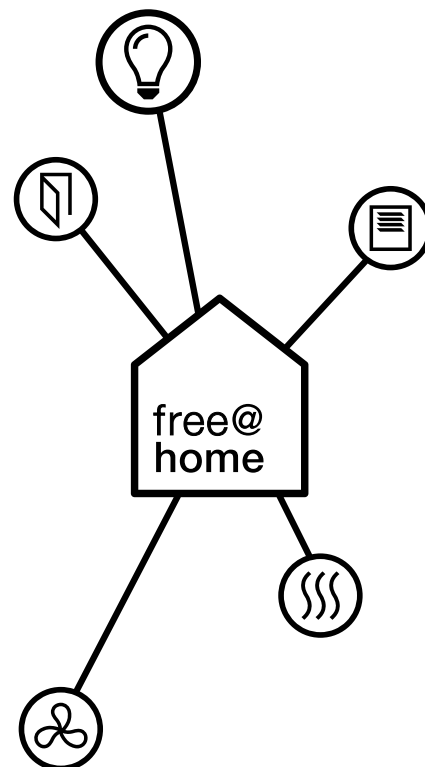





---

## Free choice

### Live as your heart desires

Smart. ABB-free@home® transforms the house or the apartment into an intelligent home. Whether blinds, lights, heating, air-conditioning or door communication – comfort, safety and efficiency can finally be remotely controlled. Via a switch on the wall, via voice control or with a smartphone, tablet or personal computer.



### The pleasure of simplicity

ABB-free@home® makes daily life easier. You can manage blinds, lights, heating, air-conditioning and door communication using just one system. The smartphone becomes the remote control in the house. It allows you to raise the blinds and switch on the radio

in the kitchen with the touch of a button while you are still in bed – or to deactivate all lights and devices via a switch when leaving the house. Very convenient. Extremely comfortable. Very energy efficient. The setting of these scenes is as easy as can be – to suit the mood or situation.

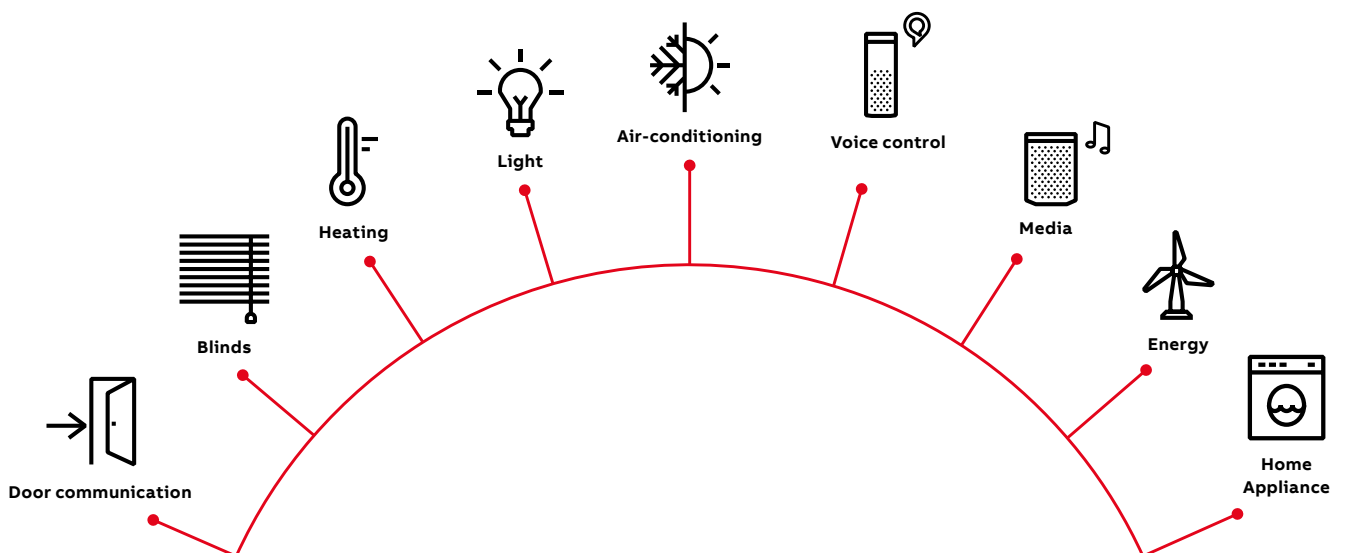

### Open for new ideas

With ABB-free@home® everyone can determine for themselves how they want to use the smart living technologies. Both individual functions, such as heating or control

of blinds, or a combination of different functions can be implemented. Over the course of time the system can also be flexibly extended, if one so desires. Freedom of choice at all times.

---

## Total networking

### Blinds, lights, heating, air-conditioning, door communication

Comfortable right from the start. It begins with commissioning and continues later when used as a part of daily life. With ABB-free@home® and Zenit all applications in and around the house are amazingly easy to combine.

#### Blinds

Whether blind, roller blind, awning or roller door – with ABB-free@home®, sun protection and energy-saving could not be easier. Opening and closing, as well as adjustment of slats can be automated and controlled with switches, ABB-free@homeTouch (two sizes are available: 7" and 4.3") or the app for smartphone or tablet. In

addition, a weather station for protection during a storm, a timer or astro function can be used. It automatically adjusts the blind according to sunrise and sunset. The relevant data are combined in the System Access Point and are precisely implemented. The panel displays a comprehensive overview of all measured values and time settings.



- Provides numerous control options, dependent on brightness, temperature, rainfall and wind speed
- Shows weather data on the smartphone, tablet and display
- Reliably protects blinds and awnings against the effects of weather
- Optimises energy efficiency



### Weather station

One thing is certain: the weather cannot be precisely predicted. The weather station records the brightness, temperature, rain and wind speed outside the home. Weather data are sent immediately and linked with actuators to automatically control functions. All important data are clearly displayed in the ABB-free@home® app.



### Blind switch

Ready for all operating modes. With either a short or long press of the button for roller blinds, exterior blinds or awnings as well as adjustment of slats. In combination with a wind sensor, the roller blinds, exterior blinds and awnings close up completely and are locked during high wind conditions.

For a reassuring feeling. The various modules interact smoothly with one another, providing extra comfort, safety and efficiency. Every detail is aesthetically lit up, in all locations, both outside and inside the home.



#### Door communication

The ABB-Welcome door communication system can be integrated into ABB-free@home®. The door communication and home automation can be used together with ABB-free@homeTouch 7". For example, the light switches on when the doorbell rings to see visitors more clearly. And for reasons of safety, the video camera records pictures of visitors at the door when no one is home.



#### Pictures shown on the display

Practical and convenient. The pictures recorded by the video camera can be displayed on the tablet or smartphone via the ABB-Welcome app. This allows visitors who ring the bell to be recognised even when you are not at home (requires the ABB-Welcome IP gateway and ABB-Welcome outdoor video station).

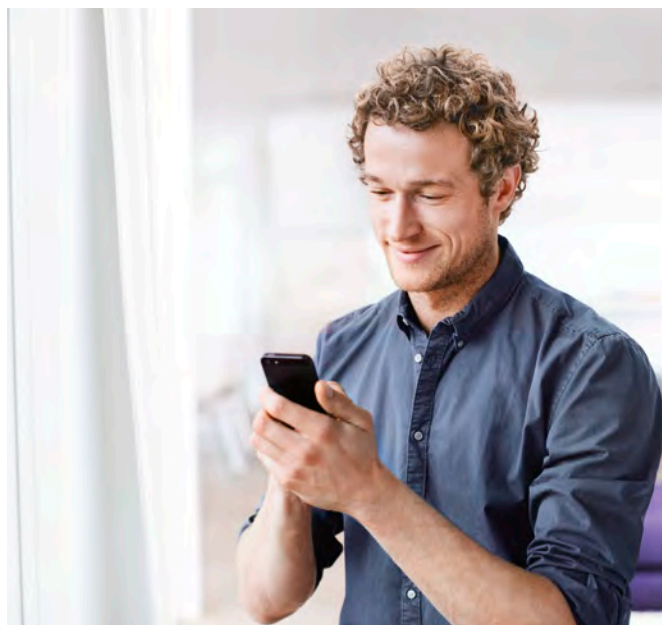

- Large touch display (7", 17.8cm), to recognise who is at the door
- Easy operation keys for opening doors, mute function and light
- Integrated picture memory
- Configuration of "Welcome scenes" when a visitor rings the bell or the door is opened

#### Smart control via app and voice

Smartphone or tablet becomes the central control unit of the door communication. The ABB-Welcome app also makes remote control via the Internet possible. This makes communication possible with all visitors. Now you are at home everywhere.

### Philips hue LEDs

Simply integrate the Philips hue LEDs into the system and control them via ABB-free@home®. This allows hue lamps to be comfortably controlled via a switch on the wall, or in a scene together with other lamps, even when the smartphone or tablet is not available.

### Light control

Life begins with light. With ABB-free@home® it can be optimally used, whether for illuminating individual rooms or the entire house. For example, with striking light scenes – for different moods and to suit the occasion. A pleasant side effect here is the cost-saving and environmentally friendly use of energy.

- Easy to adjust light scenes
- Central or remote control
- Fast activation of emergency lighting
- Support of energy efficiency
- Flexible use
- Philips hue LED integration

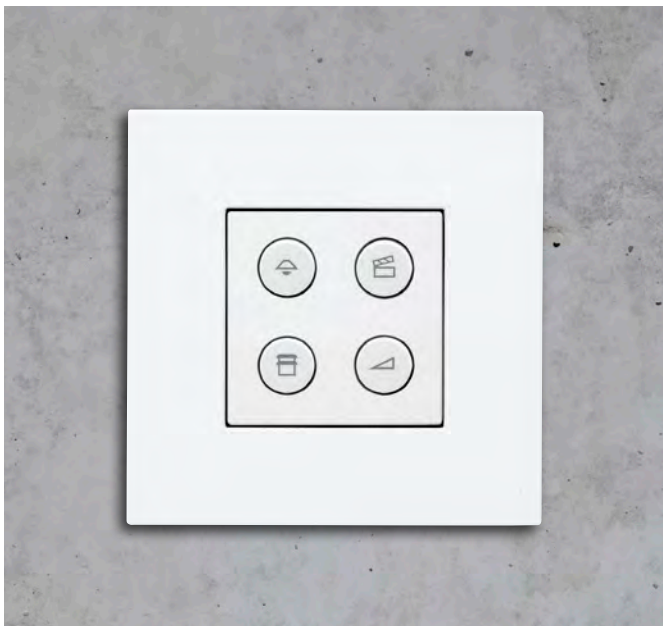

### Dimmer and movement detector

With ABB-free@home®, rooms or entire buildings can be illuminated according to your requirements. Each situation receives suitable light – whether striking light scenes or emergency lighting. All lights are switched on at once.

Pleasantly economical. The ideal room temperature throughout the day and night is the result of precise control. ABB free@home® connects all components for a fine-tuned indoor climate.



#### Heating and air-conditioning

Comfortable and energy-saving. The optimum room temperature can be adjusted with ABB-free@home® according to the actual requirement. In ECO mode, the temperature is automatically lowered at night or when no one is home. The heating can be automatically shut off when the windows are open. This reduces the energy consumption – whether for conventional heaters or under-floor heating.

The ideal temperature is never the same. Depending on the time of the day, the room temperature controller provides your personal feel-good temperature. The heating valves are controlled wirelessly – with radio-controlled thermal actuating drives. The room temperature controllers can be integrated into the switch combination. And the window contacts are net-worked wirelessly as well. That is both smart and efficient.





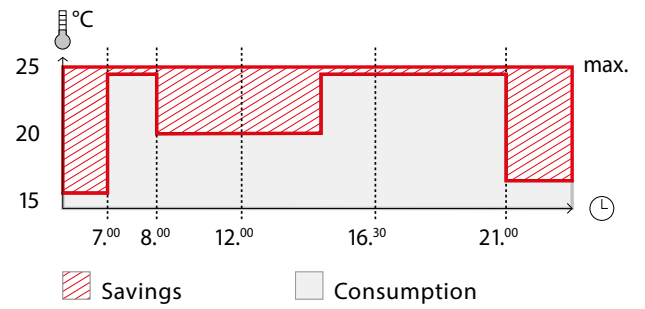

### Intelligent thermostat

Radiator Thermostats drives are the active components of individual room temperature control. They control the valve of the respective radiator. These drives use an electric motor to open or close the heating valves. They are battery powered and operate quietly. The ABB-free@home® network enables the finest nuances to be implemented, for the perfect climate at all times.

- Easy to retrofit
- No cooling or heating when windows are open

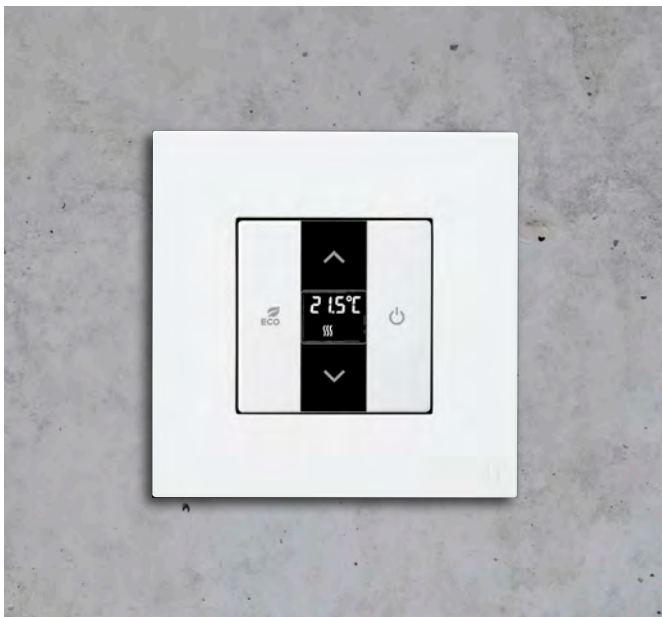

- Heating to suit individual requirements: depending on the daily routines instead of specific requirements
- For conventional heaters or under-floor heating
- Support of energy efficiency
- ECO mode
- Local operation or remote controlled via app for smartphone and tablet

The smooth integration of modern household appliances into ABB-free@home® offers a variety of options for convenient use. All networked devices with their icons are displayed in the free@home app and the ABB-free@home® panel and can be controlled from there. All functions can also be directly controlled via the wall-mounted push-buttons, which is possible only with free@home.

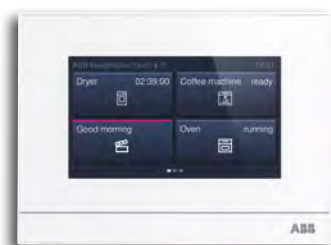

All Smart-Home-capable devices from Miele and Home Connect can be integrated in ABB-free@home® without any difficulty.



The washing machine and the drier immediately signal on the panel and the free@home app when they are finished. Practical and time-saving. Because it makes the constant checking in the cellar unnecessary.

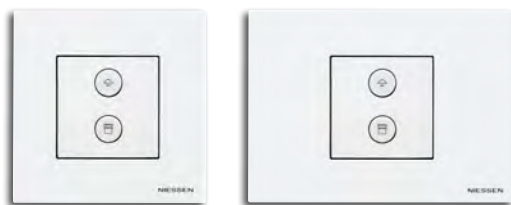
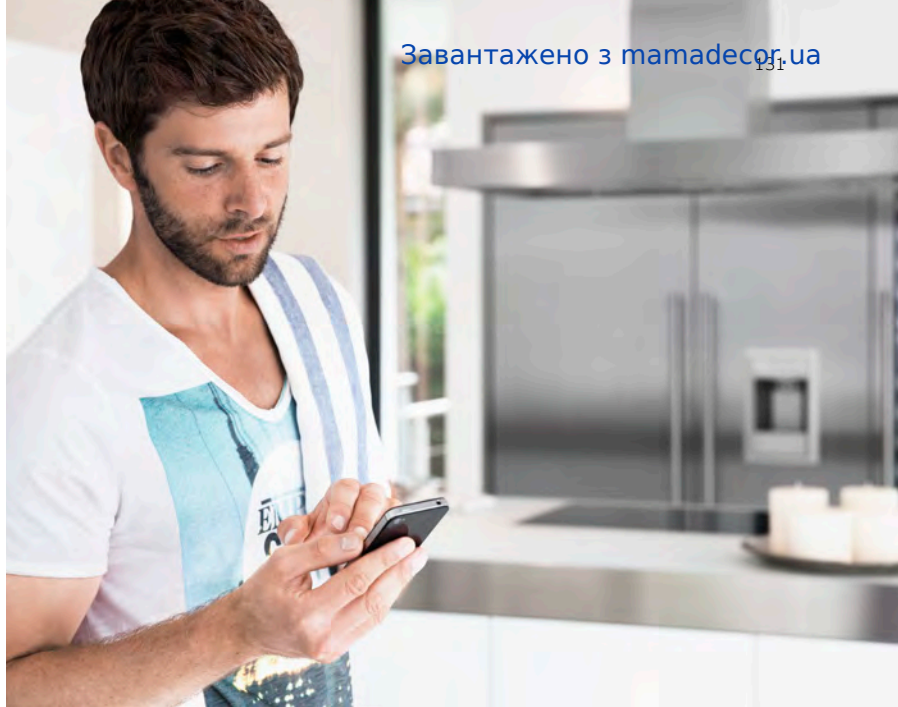

Cooking becomes more comfortable. Because now also the light and ventilation of the extractor hood can be integrated into the "cooking scene". And the "everything-off scene" now also switches the extractor hood completely off. Or only its light, if desired. All household appliances can even be conveniently controlled (without app!) via the wall-mounted push-buttons – exclusive with ABB-free@home®.

Always the irritating questions! Did I switch off the light in the cellar? Did I forget to close the refrigerator door? With ABB-free@home® these worries are now a thing of the past. Because the app informs you immediately and also reminds you.



The start into the day gets better and better. Because when the "good morning scene" is selected, also the coffee machine switches itself on - as if by magic.



The oven must be off when there is no one at home. ABB-free@home® ensures that it is switched off as soon as you leave the house. Reliable and safe. To ensure that you have no reason to worry.

---

**THE SYSTEM**

ABB-free@home® is easy to operate and at the same time flexible and adaptable to everyday situations or to those very special moments in life. And here, complete scenes can be played automatically or be set or called up spontaneously to suit the mood

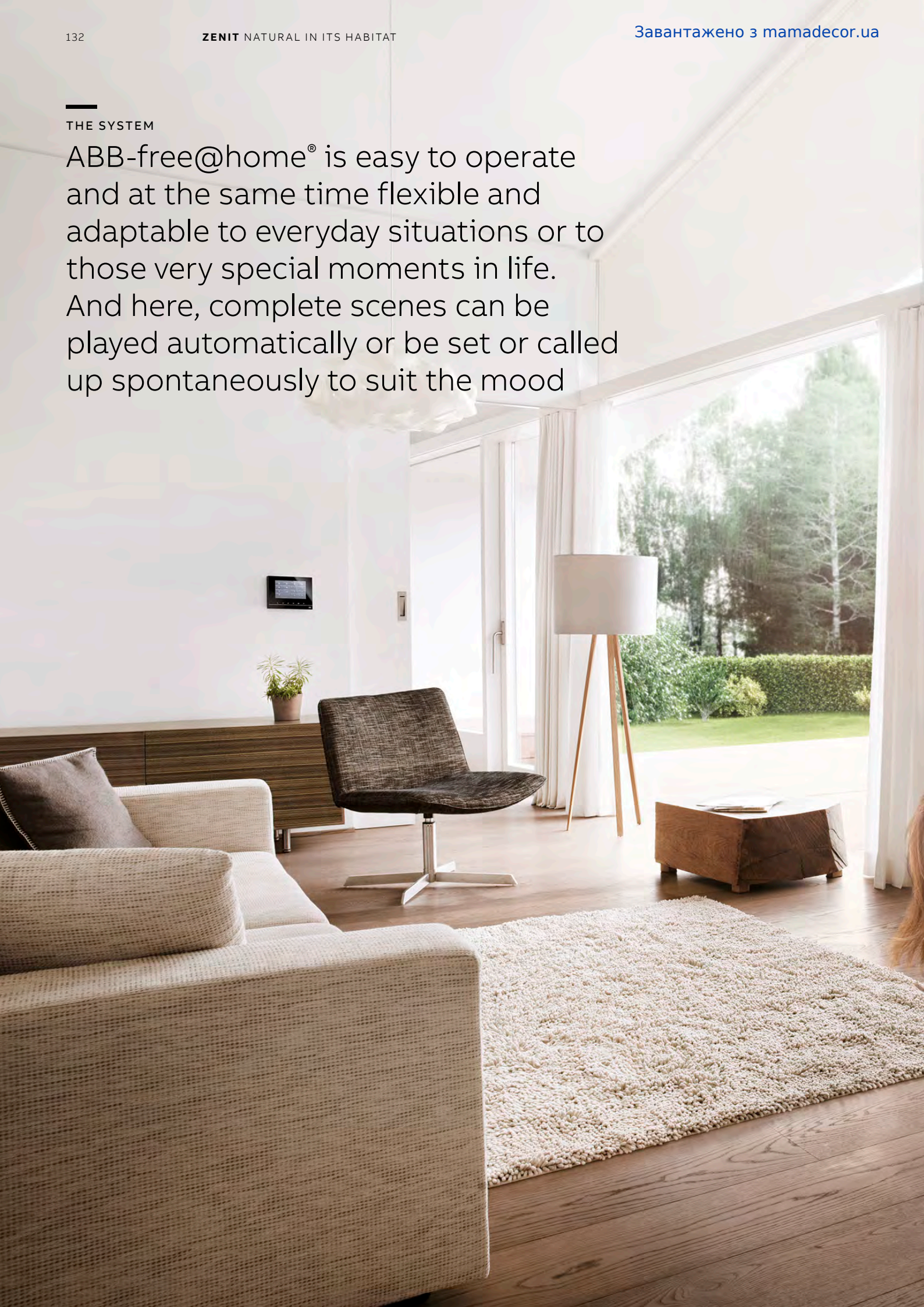



---

# Atmosphere at the press of a button

## With a personal comfort scene

The perfect evening after a long day at work. Simply at the press of a button. ABB-free@home® cares for a friendly reception when arriving at home. With a colorful display of light, pleasant room temperature and your favorite music. Precisely the right atmosphere for relaxing.

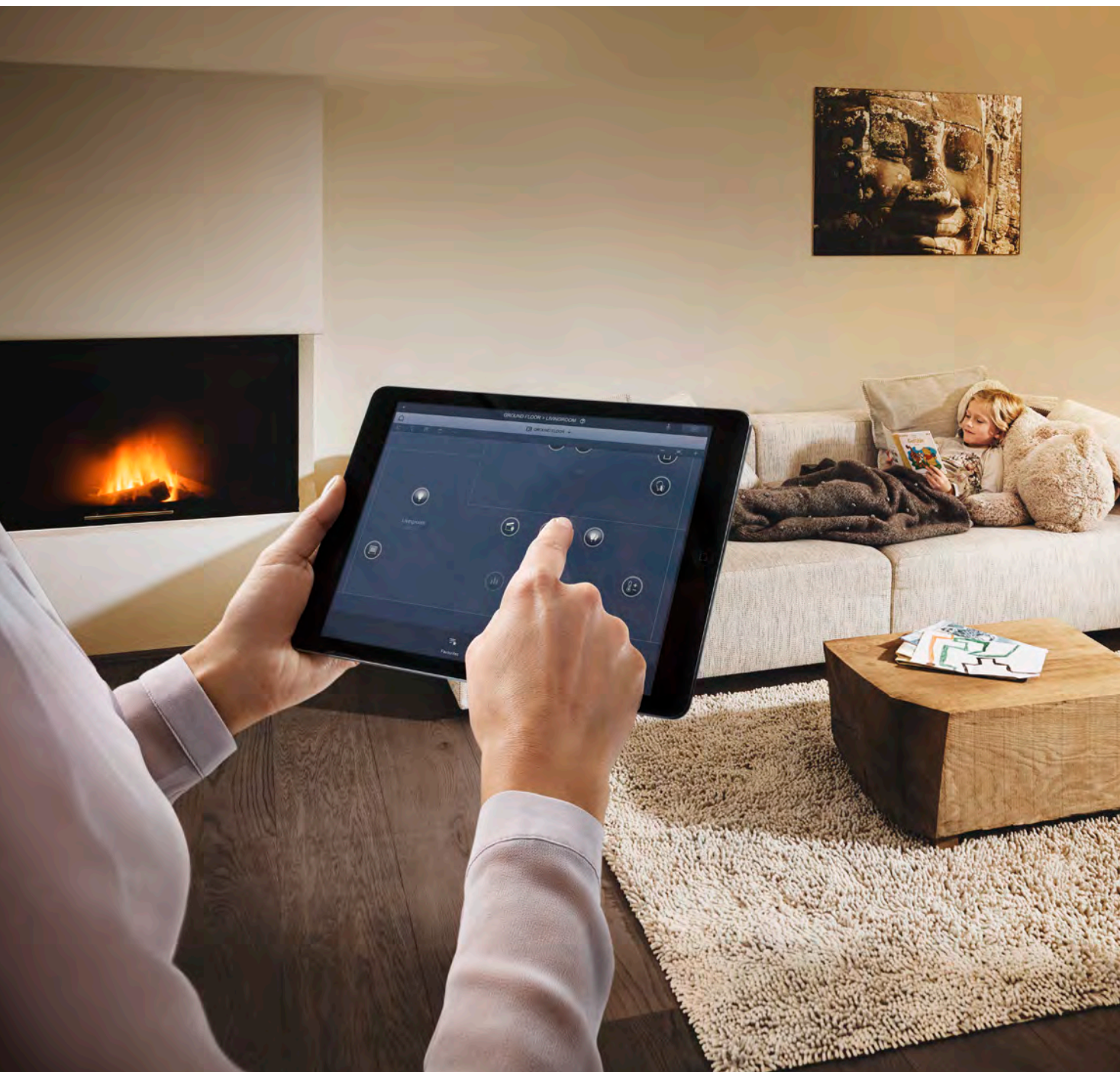

**Sonos**

Never has the enjoyment of music been so comfortable in all rooms. Because the Sonos wireless home sound system harmonizes perfectly with ABB-free@home®. All Sonos loudspeakers can be easily operated fully integrated: via free@home wall sensors and touch panels or via ABB-free@home® app. The replay of music, the selection of your Sonos favourites or the volume control are simplicity itself.

**Philips hue LEDs**

All functions of the Philips hue LEDs can be integrated in a scene. In addition to the brightness, the colour shade can also be defined in a scene.

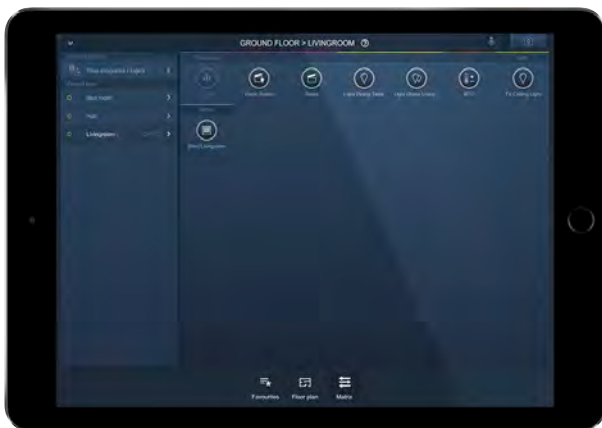
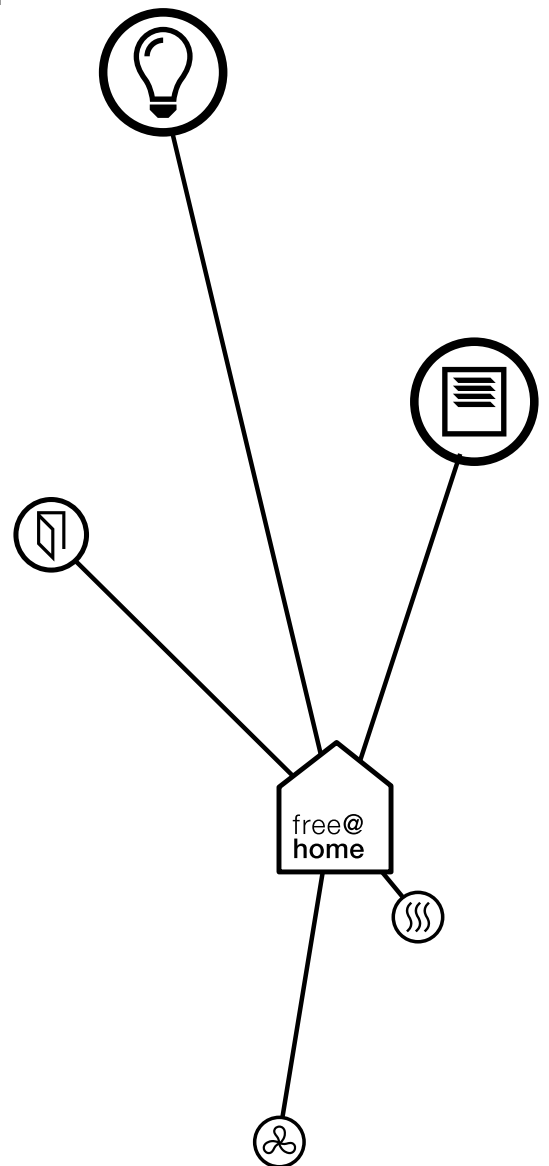
**Fast change of scene**

A single press of the button on the switch, on the ABB-free@homeTouch, smartphone or tablet suffices to call up a complete scene. This, for example, allows a living room to be transformed in a matter of seconds to suit an occasion – for welcoming guests or for a pleasant evening of relaxation.

**Simple scene configuration**

To create or change your own individual scenes is child's play with ABB-free@home®. An intelligent assistance wizard helps to put together the desired functions. This, for example, allows the working light, cooker hood and Internet radio to be simultaneously activated via a binary output, while also dimming the light at the dinner table – again with a press of a button.

# Present and yet not at home

## With presence simulation

Everything is in perfect order at home. Because ABB-free@home® and Zenit bring life into rooms that are at times unoccupied. For this the system stores the habits of the residents while they are at home and then calls them up during their absence.

- Free app for iOS and Android devices
- Integrated picture memory
- Easy remote control via MyBuildings portal powered by ABB Ability



### Presence simulation

Always a good feeling. Because the presence simulation of ABB-free@home® records the weekly actions of all devices in the home. And this is how it convincingly simulates the presence of the owners. No matter whether they are on a business trip, on holiday or just shopping around the corner. The impression always remains the same: someone is at home.

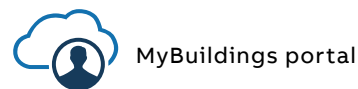

### Everything controllable

Via the connection to the MyBuildings portal powered by ABB Ability, most functions of ABB-free@home® can now be controlled and activated via remote control. This makes it possible to maintain control – even while on holiday, with maximum protection of one's privacy. Those who do not use a remote control can operate their ABB-free@home® system from the cloud.



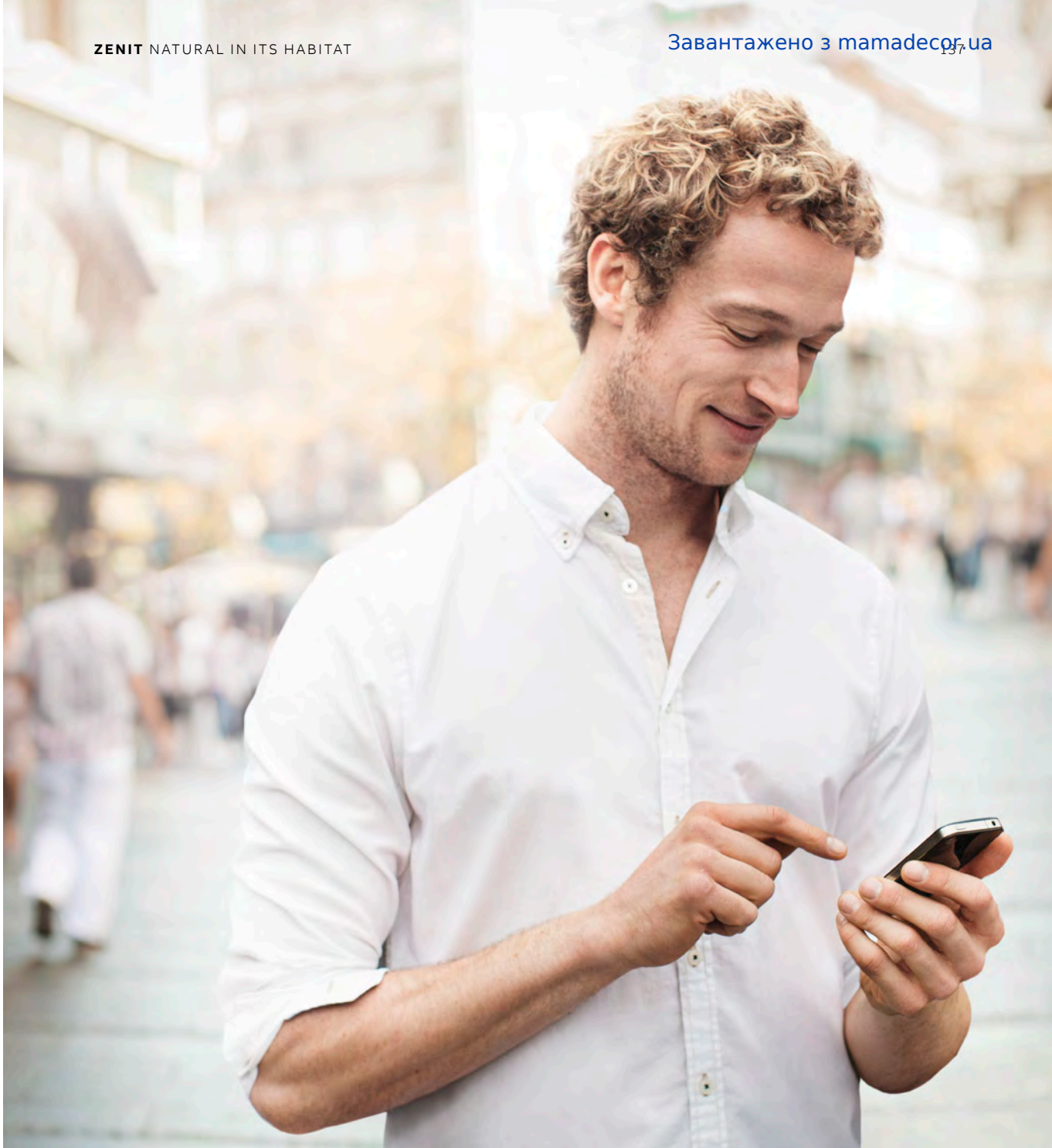

### Geofencing

The innovative Geofencing function of ABB-free@home® makes it possible for home owners to surround the house or other locations with an imaginary fence. If someone enters or leaves this defined zone, free@home automatically responds with previously specified actions. For example, the system switches off the lights and adjusts the heating, to save energy when all residents have left the house. Or it regulates the room temperature as soon as one leaves the place of work in the evening so that the home is warm and cosy when arriving at home.

---

# Everything off with a single function

## A reassuring feeling

The simplest type of switch-off. ABB-free@home® offers this with the everything-off function. It is especially practical when leaving the house. It simultaneously switches off all networked devices in all rooms.



### Rest assured

In principle the everything-off function works just like a preset scene. In this case all networked devices are simultaneously switched off in all rooms. Aside from improving safety, this also improves energy efficiency.

The everything-off function is especially practical at the bedside. Before falling asleep the entire lighting in the house can be switched off with just a press of a button. A very practical function that adds comfort and safety.

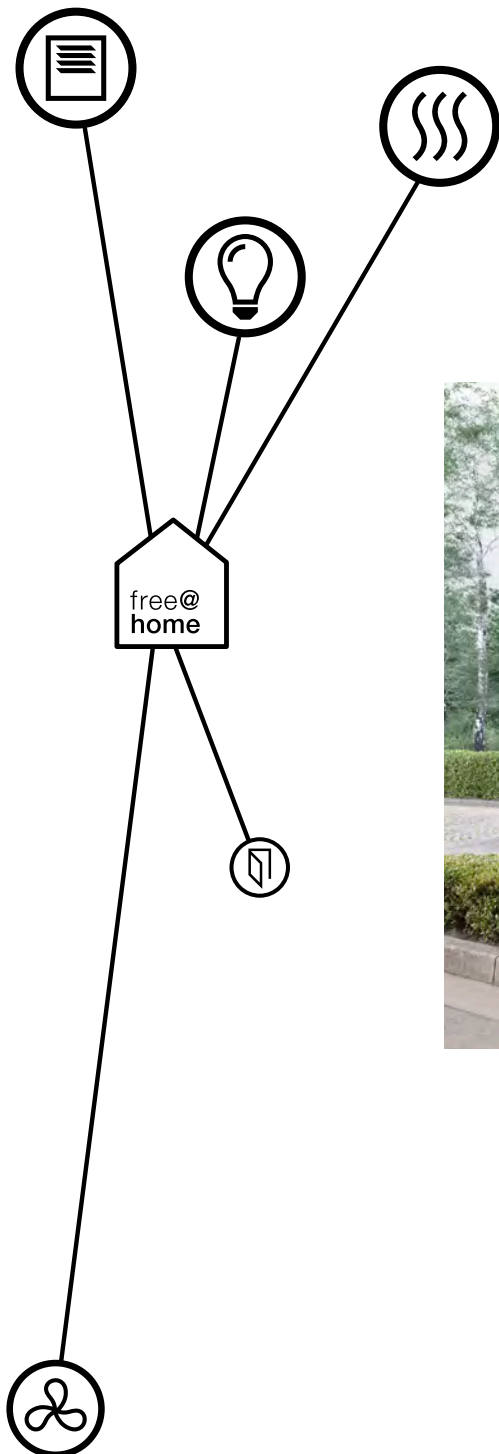

- Pre-programmed everything-off switch
- Easy to operate



#### **Near and far**

The central switch for the everything-off function can be located on the wall near the front door and, of course, at any other location in the house. And for mobile use it can be displayed in the app on the smartphone or tablet.

## Easy to use

### A variety of control options

The new independence. Creating the perfect indoor climate or ideal illumination can now be done via flexible and precise remote control – with the touch of a finger or voice commands. Operation as simple as desired.



*"Alexa, play music that puts me in a happy mood."*



#### Alexa

Amazon Echo controls lamps, light switches and thermostats, plays music, supplies news and much more – and all this simply via voice control.



#### Tablet and smartphone

The operating concept provides the highest flexibility and mobility because everyone has the choice to control the functions also mobile via the smartphone or tablet. And thanks to the ABB-free@home® app, also with the tip of the finger while travelling. Easier than ever.



#### ABB-free@homeTouch

Thanks to its two different colours (black and white) and its two different sizes (7" and 4.3"). Offers up to 16 functions, and intuitive operation via tapping or swiping. Easy to set up and even easier to operate – plus making adjustments is a snap.

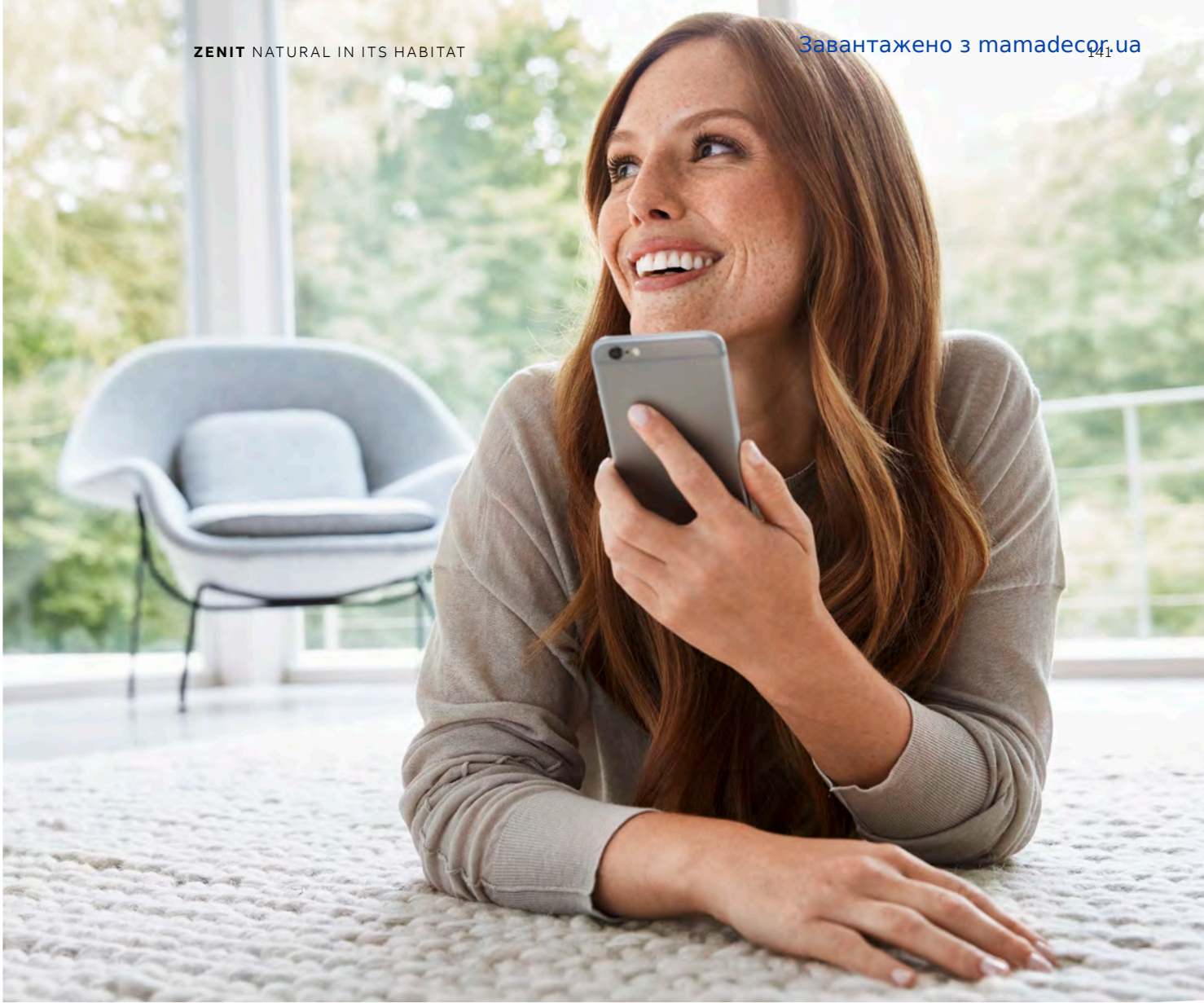
**The modern switch**

The easiest operation is the one everyone is used to. And today's wall switch is always in the right place. This is especially so because the wireless version makes additional cabling unnecessary. Switches are the better performers.

## Zenit

### Sensors

Product	Article-No.	Order-No.	Pack/Qty
	<b>free@home Sensor unit 1-gang - 2M</b> For sending switching, dimming and blind commands to an ABB-free@home® actuator. To be used with ABB-free@home® 2 fold push buttons. Control element: Switch contacts top/ bottom. Display elements: LED as light for orientation or display of switching state. Protection class of device: IP 20. Mounting depth: 14,1 mm. To be installed with SR-2-N2 cover plates.		
	<b>SU-F-1.0.PB.1</b>	2CKA006220A0222	1

	<b>free@home Sensor unit 2-gang - 2M</b> For sending switching, dimming and blind commands to an ABB-free@home® actuator. To be used with ABB-free@home® 4 fold push buttons. Control element: Switch contacts top/ bottom. Display elements: LED as light for orientation or display of switching state. Protection class of device: IP 20. Mounting depth: 14,1 mm. To be installed with SR-4-N2 cover plates.		
	<b>SU-F-2.0.PB.1</b>	2CKA006220A0223	1

### Sensor & switch actuators

	<b>free@home Sensor/Switch actuator 1/1-gang - 2M</b> For switching 127/230 V~ devices. With 1 integrated switch actuator. Switching function is available pre-configured. Use with ABB-free@home® 2 fold push buttons. Outputs: 1× normally open contact, potential free. Suitable for: resistive. Rated current: 10 A. Rated power: 2300 W. Suitable for: capacitive. Rated current: 10 AX. Protection class of device: IP 20. Mounting depth: 31,5 mm. To be installed with SR-2-N2 cover plates.		
	<b>SSA-F-1.1.PB.1</b>	2CKA006220A0232	1

	<b>free@home Sensor/Switch actuator 2/1-gang - 2M</b> For switching 127/230 V~ devices. With 1 integrated switch actuator. Switching function is available pre-configured. Use with ABB-free@home® 4 fold push buttons. Outputs: 1× normally open contact, potential free. Suitable for: resistive. Rated current: 10 A. Rated power: 2300 W. Suitable for: capacitive. Rated current: 10 AX. Protection class of device: IP 20. Mounting depth: 31,5 mm. To be installed with SR-4-N2 cover plates.		
	<b>SSA-F-2.1.PB.1</b>	2CKA006220A0233	1

### Sensor & switch actuators

Product	Article-No.	Order-No.	Pack/Qty
	<b>free@home Sensor/Switch actuator 2/2-gang - 2M</b> For switching 127/230 V~ devices. With 1 integrated switch actuator. Switching function is available pre-configured. Use with ABB-free@home® 4 fold push buttons. Outputs: 2× normally open contact, potential free. Suitable for: resistive. Rated current: 10 A. Rated power: 2 x 1200 W. Suitable for: capacitive. Rated current: 10 AX. Protection class of device: IP 20. Mounting depth: 31,5 mm. To be installed with SR-4-N2 cover plates.		
	<b>SSA-F-2.2.PB.1</b>	2CKA006220A0234	1

### Sensor & dimmer actuators

	<b>free@home Sensor/Dimmer actuator 1/1-gang - 2M</b> For dimming 127/230 V~ loads. With integrated universal dimming. Actuator for controlling different lamps. The dimming function. Is available pre-configured. Use with ABB-free@home® 2 fold push buttons. Outputs: 1× dimming channel. Suitable for: 230 V incandescent lamps and low-voltage. Halogen lamps with conventional transformers or electronic. Transformers. Rated power: 10–180 W/VA. Suitable for: LEDi and energy-saving bulbs. Rated power: 2–80 W/VA. Protection class of device: IP 20. Mounting depth: 31,5 mm. To be installed with SR-2-N2 cover plates.		
	<b>SDA-F-1.1.PB.1</b>	2CKA006220A0235	1

	<b>free@home Sensor/Dimmer actuator 2/1-gang - 2M</b> For dimming 230 V~ loads. With integrated universal dimming actuator for controlling different lamps. The dimming function is available pre-configured. Use with ABB-free@home® 4 fold push buttons. Outputs: 1× dimming channel. Suitable for: 230 V incandescent lamps and low-voltage halogen lamps with conventional transformers or electronic transformers. Rated power: 10–180 W/VA. Suitable for: LEDi and energy-saving bulbs. Rated power: 2–80 W/VA. Protection class of device: IP 20. Mounting depth: 31,5 mm. To be installed with SR-4-N2 cover plates.		
	<b>SDA-F-2.1.PB.1</b>	2CKA006220A0236	1

## Zenit

### Sensor & blind actuators

Product	Article-No.	Order-No.	Pack/Qty
	<b>free@home Sensor/Blind actuator 1/1-gang - 2M</b>		
	For controlling blind and awning motors. With integrated blind actuator. Blind function is available pre-configured. To be used with ABB-free@home® 2 fold push buttons. Outputs: 1× Change-over contacts/normally open contact, potential-bound. Rated power: 920 VA. Rated current: 4 A. Suitable for: Operating mode blind. Protection class of device: IP 20. Mounting depth: 31,5 mm. To be installed with SR-2-N2 cover plates.		
	<b>SBA-F-1.1.PB.1</b>	2CKA006220A0237	1

	<b>free@home Sensor/Blind actuator 2/1-gang - 2M</b>		
	For controlling blind and awning motors. With integrated blind actuator. Blind function is available pre-configured. To be used with ABB-free@home® 4 fold push buttons. Outputs: 1× Change-over contacts/normally open contact, potential-bound. Rated power: 920 VA. Rated current: 4 A. Suitable for: Operating mode blind. Protection class of device: IP 20. Mounting depth: 31,5 mm. To be installed with SR-4-N2 cover plates.		
	<b>SBA-F-2.1.PB.1</b>	2CKA006220A0238	1

### Sensor & dimmer actuators

	<b>free@home Room temperature controller - 2M</b>		
	Room temperature control function for controlling commercially available valve drives or analogue valve drives (continuous controllers). With display of set-value temperature. Only to be used with ABB-free@home® Zenit cover plates for room thermostat. Display elements: LCD Display showing operation modes. Protection class of device: IP 20. Mounting depth: 17,9 mm. To be installed with CP-RTC-N2 or CP-RTC-FC-N2 cover plates.		
	<b>RTC-F-1.PB</b>	2CKA006220A0276	1

### Motion sensor & actuators

Product	Article-No.	Order-No.	Pack/Qty
	<b>free@home 180° motion sensor - 2M</b>		
	With select lens for detection with animal access. For automatic switching of ABB-free@home® actuators dependent on movement and brightness. To be used with ABB-free@home® Zenit cover plates for movement detector. Detection range: frontal 6 m, lateral 3 m. Detection angle: 180°. Brightness limit value: 1 – 500 lux. Protection class of device: IP 20. Mounting depth: 14.1 mm. To be installed with CP-MD-N2 cover plates.		
	<b>MD-F-1.0.PB.1</b>	2CKA006220A0229	1

	<b>free@home 180° motion sensor/actuator - 2M</b>		
	With select lens for detection with animal access. Including an integrated actuator for switching 230 V~ devices. To be used with ABB-free@home® Zenit cover plates for movement detector. Outputs: 1× normally open contact, potential free. Suitable for: resistive. Rated current: 10 A. Rated power: 2300 W. Suitable for: capacitive. Rated current: 10 AX. Detection range: frontal 6 m, lateral 3 m. Detection angle: 180°. Brightness limit value: 1 – 500 lux. Protection class of device: IP 20. Mounting depth: 31.5 mm. To be installed with CP-MD-N2 cover plates.		
	<b>MSA-F-1.1.PB.1</b>	2CKA006220A0231	1

## Zenit

### Sensors - Wireless

Product	Article-No.	Order-No.	Pack/Qty
	<b>free@home Wireless sensor unit 1-gang - 2M</b> Wireless communication with the system. For sending switching, dimming and blind commands to an ABB-free@home® actuator. To be used with ABB-free@home® 2 fold push buttons. Control element: Switch contacts top/ bottom. Display elements: LED as light for orientation or display. of switching state. Protection class of device: IP 20. Mounting depth: 14,1 mm. To be installed with SR-2-N2 cover plates.		
	<b>SU-F-1.0.PB.1-WL</b>	2CKA006200A0106	1

	<b>free@home Wireless sensor unit 2-gang - 2M</b> Wireless communication with the system. For sending switching, dimming and blind commands to an ABB-free@home® actuator. To be used with ABB-free@home® 4 fold push buttons. Control element: Switch contacts top/ bottom. Display elements: LED as light for orientation or display. of switching state. Protection class of device: IP 20. Mounting depth: 14,1 mm. To be installed with SR-4-N2 cover plates.		
	<b>SU-F-2.0.PB.1-WL</b>	2CKA006200A0107	1

### Sensors & switch actuators - Wireless

	<b>free@home Wireless sensor / Switch actuator 1/1-gang - 2M</b> Wireless communication with the system. For switching 230 V~ devices. With 1 integrated switch actuator. Switching function is available pre-configured. Use with ABB-free@home® 2 fold push buttons. Outputs: 1x normally open contact, potential free. Suitable for: resistive. Rated current: 10 A. Rated power: 2300 W. Suitable for: capacitive. Rated current: 10 AX. Protection class of device: IP 20. Mounting depth: 31,5 mm. To be installed with SR-2-N2 cover plates.		
	<b>SSA-F-1.1.PB.1-WL</b>	2CKA006200A0108	1

	<b>free@home Wireless sensor / Switch actuator 2/1-gang - 2M</b> Wireless communication with the system. For switching 230 V~ devices. With 1 integrated switch actuator. Switching function is available pre-configured. Use with ABB-free@home® 4 fold push buttons. Outputs: 1x normally open contact, potential free. Suitable for: resistive. Rated current: 10 A. Rated power: 2300 W. Suitable for: capacitive. Rated current: 10 AX. Protection class of device: IP 20. Mounting depth: 31,5 mm. To be installed with SR-4-N2 cover plates.		
	<b>SSA-F-2.1.PB.1-WL</b>	2CKA006200A0109	1

### Sensors & switch actuators - Wireless

Product	Article-No.	Order-No.	Pack/Qty
	<b>free@home Wireless sensor / Switch actuator 2/2-gang - 2M</b> Wireless communication with the system. For switching 230 V~ devices. With 1 integrated switch actuator. Switching function is available pre-configured. Use with ABB-free@home® 4 fold push buttons. Outputs: 2x normally open contact, potential free. Suitable for: resistive. Rated current: 10 A. Rated power: 2 x 1200 W. Suitable for: capacitive. Rated current: 10 AX. Protection class of device: IP 20. Mounting depth: 31,5 mm. To be installed with SR-4-N2 cover plates.		
	<b>SSA-F-2.2.PB.1-WL</b>	2CKA006200A0110	1

### Sensors & dimmer actuators - Wireless



	<b>free@home Wireless sensor / Dimmer actuator 1/1-gang - 2M</b> Wireless communication with the system. For dimming 230 V~ loads. With integrated universal dimming. Actuator for controlling different lamps. The dimming function. Is available pre-configured. Use with ABB-free@home® 2 fold. Push buttons. Outputs: 1x dimming channel. Suitable for: 230 V incandescent lamps and low-voltage. Halogen lamps with conventional transformers or electronic. Transformers. Rated power: 10-180 W/VA. Suitable for: LEDi and energy-saving bulbs. Rated power: 2-80 W/VA. Protection class of device: IP 20. Mounting depth: 31,5 mm. To be installed with SR-2-N2 cover plates.		
	<b>SDA-F-1.1.PB.1-WL</b>	2CKA006200A0111	1

	<b>free@home Wireless sensor / Dimmer actuator 2/1-gang - 2M</b> Wireless communication with the system. For dimming 230 V~ loads. With integrated universal dimming actuator for controlling different lamps. The dimming function is available pre-configured. Use with ABB-free@home® 4 fold push buttons. Outputs: 1x dimming channel. Suitable for: 230 V incandescent lamps and low-voltage halogen lamps with conventional transformers or electronic transformers. Rated power: 10-180 W/VA. Suitable for: LEDi and energy-saving bulbs. Rated power: 2-80 W/VA. Protection class of device: IP 20. Mounting depth: 31,5 mm. To be installed with SR-4-N2 cover plates.		
	<b>SDA-F-2.1.PB.1-WL</b>	2CKA006200A0112	1





## Zenit

### Sensors & blind actuators - Wireless

Product	Article-No.	Order-No.	Pack/Qty
 <p><b>free@home Wireless sensor/ Blind actuator 1/1-gang - 2M</b> Wireless communication with the system. For controlling blind and awning motors. With integrated blind actuator. Blind function is available pre-configured. To be used with ABB-free@home® 2 fold push buttons. Outputs: 1× Change-over contacts/normally open contact, potential-bound. Rated power: 920 VA. Rated current: 4 A. Suitable for: Operating mode blind. Protection class of device: IP 20. Mounting depth: 31,5 mm. To be installed with SR-2-N2 cover plates.</p>	<b>SBA-F-1.1.PB.1-WL</b>	2CKA006200A0113	1
 <p><b>free@home Wireless sensor/ Blind actuator 2/1-gang - 2M</b> Wireless communication with the system. For controlling blind and awning motors. With integrated blind actuator. Blind function is available pre-configured. To be used with ABB-free@home® 4 fold push buttons. Outputs: 1× Change-over contacts/normally open contact, potential-bound. Rated power: 920 VA. Rated current: 4 A. Suitable for: Operating mode blind. Protection class of device: IP 20. Mounting depth: 31,5 mm. To be installed with SR-4-N2 cover plates.</p>	<b>SBA-F-2.1.PB.1-WL</b>	2CKA006200A0114	1

### Room temperature controllers - Wireless





Product	Article-No.	Order-No.	Pack/Qty
 <p><b>free@home Wireless room temperature controller - 2M</b> Wireless communication with the system. Room temperature control function for controlling commercially available valve drives or analogue valve drives (continuous controllers). With display of set-value temperature. Display elements: LCD Display showing operation modes. Mounting depth: 17,9 mm. To be installed with CP-RTC-N2 or CP-RTC-FC-N2 cover plates.</p>	<b>RTC-F-1.PB-WL</b>	2CKA006200A0115	1
 <p><b>free@home Wireless RTC / Heating actuator - 2M</b> Wireless communication with the system. Heating/cooling operation. Control element with room temperature controller function. With display of set-value temperature. With integrated switch actuator, e.g. for controlling thermoelectric actuating drives in heating/cooling systems or electric floor heating systems. RTC function is available also without prior programming (pre-configured). 3 wire connection (neutral conductor required). Control element: Floating rocker for the selection of set values and operating modes Display elements: LCD showing operation modes Rated voltage: 230 V~ / 50-60 Hz Outputs: 1 Normally open contact, potential-bound Suitable for: ohmic Rated current: 16 A Output voltage: 230 V~ Rated power: 3680 W Mounting depth: 32 mm. To be installed with CP-RTC-N2 cover plates.</p>	<b>RTC-F-2.1.1.PB-WL</b>	2CKA006200A0116	1

### Motion sensor & actuator - Wireless

 <p><b>free@home Wireless 180° motion sensor/ actuator - 2M</b> Wireless communication with the system. With select lens for detection with animal access. Including an integrated actuator for switching 230 V~ devices. To be used with ABB-free@home® Zenit cover plates for movement detector. Outputs: 1× normally open contact, potential free. Suitable for: resistive. Rated current: 10 A. Rated power: 2300 W. Suitable for: capacitive. Rated current: 10 AX. Detection range: frontal 6 m, lateral 3 m. Detection angle: 180°. Brightness limit value: 1 – 500 lux. Protection class of device: IP 20. Mounting depth: 31.5 mm. To be installed with CP-MD-N2 cover plates.</p>	<b>MSA-F-1.1.1-WL</b>	2CKA006200A0117	1
--	-----------------------	-----------------	---

## Zenit

### Covers for sensors & actuators





Color	Article-No.	Order-No.	Pack/Qty
 <p><b>Cover plate - free@home 1-gang sensors - 2M</b> Cover plate for free@home sensors and sensor/actuators with 1-gang sensors code: SU-F-1.0.PB.1, SSA-F-1.1.PB.1, SDA-F-1.1.PB.1 and SBA-F-1.1.PB.1. Included: 2 buttons without symbol.</p>			
White	<b>SR-2-N2 BL</b>	2CLA222620N1102	5
Silver	<b>SR-2-N2 PL</b>	2CLA222620N1302	5
Anthracite	<b>SR-2-N2 AN</b>	2CLA222620N1802	5
Champagne	<b>SR-2-N2 CV</b>	2CLA222620N1902	5
 <p><b>Cover plate - free@home 2-gang sensors - 2M</b> Cover plate for free@home sensors and sensor/actuators with 2-gang sensors code: SU-F-2.0.PB.1, SSA-F-2.1.PB.1, SDA-F-2.1.PB.1 and SBA-F-2.1.PB.1. Included: 4 buttons without symbol.</p>			
White	<b>SR-4-N2 BL</b>	2CLA222640N1102	5
Silver	<b>SR-4-N2 PL</b>	2CLA222640N1302	5
Anthracite	<b>SR-4-N2 AN</b>	2CLA222640N1802	5
Champagne	<b>SR-4-N2 CV</b>	2CLA222640N1902	5
 <p><b>Cover plate - free@home RTC - 2M</b> Cover plate with RTC symbols for free@home room temperature controller code RTC-F-1.PB.</p>			
White	<b>CP-RTC-N2 BL</b>	2CLA224060N1102	5
Silver	<b>CP-RTC-N2 PL</b>	2CLA224060N1302	5
Anthracite	<b>CP-RTC-N2 AN</b>	2CLA224060N1802	5
Champagne	<b>CP-RTC-N2 CV</b>	2CLA224060N1902	5
 <p><b>Cover plate - free@home fan coil control - 2M</b> Cover plate with fan coil control symbols for free@home room temperature controller code RTC-F-1.PB.</p>			
White	<b>CP-RTC-FC-N2 BL</b>	2CLA225420N1102	5
Silver	<b>CP-RTC-FC-N2 PL</b>	2CLA225420N1302	5
Anthracite	<b>CP-RTC-FC-N2 AN</b>	2CLA225420N1802	5
Champagne	<b>CP-RTC-FC-N2 CV</b>	2CLA225420N1902	5
 <p><b>Cover plate - free@home motion sensor - 2M</b> Cover plate for free@home motion sensors and sensor/actuators code: MD-F-1.0.PB.1 and MSA-F-1.1.PB.1.</p>			
White	<b>CP-MD-N2 BL</b>	2CLA224160N1102	5
Silver	<b>CP-MD-N2 PL</b>	2CLA224160N1302	5
Anthracite	<b>CP-MD-N2 AN</b>	2CLA224160N1802	5
Champagne	<b>CP-MD-N2 CV</b>	2CLA224160N1902	5

### Buttons with symbols



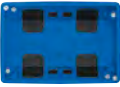

Color	Article-No.	Order-No.	Pack/Qty
 <p><b>free@home button with symbol</b> Button with free@home symbol for sensor and sensor/actuator's cover plates code: SR-2-N2 and SR-4-N2. - SBL: light symbol. - SBB: blind symbol. - SBS: scene symbol. - SBD: dimmer symbol.</p>			
White	<b>SBL-N2BL</b>	2CLA202610N1102	20
Gray	<b>SBL-N2GR</b>	2CLA202610N1402	20
White	<b>SBB-N2BL</b>	2CLA202620N1102	20
Gray	<b>SBB-N2GR</b>	2CLA202620N1402	20
White	<b>SBS-N2BL</b>	2CLA202630N1102	20
Gray	<b>SBS-N2GR</b>	2CLA202630N1402	20
White	<b>SBD-N2BL</b>	2CLA202640N1102	20
Gray	<b>SBD-N2GR</b>	2CLA202640N1402	20

## Zenit

### Touch displays

Color	Article-No.	Order-No.	Pack/Qty
 <p><b>ABB-free@homeTouch 7"</b> For the central control of up to 16 configurable ABB-free@home® functions of type: switching, dimming, blind, RTC, scene, Philips HUE. Display of the video image of the outdoor station of ABB-Welcome door entry system. Suitable as room temperature controller extension unit (up to 8). Surface mounting. The bus can be connected via enclosed terminal block. Display size / resolution: 17.8 cm (7") / 800 x 480 Consumer units: 11 Display elements: TFT Touch Display Dimensions: (L x W x D): 155 mm x 218 mm x 29 mm Programming only with bus voltage applied via the web interface of the System Access Point. The power is supplied by the ABB-Welcome system controller or when using the ABB-free@home panel without an ABB-Welcome system, a separate ABB 24 V- power supply is required. Protection class (device): IP30 Temperature range (device): -5 °C to 40 °C</p>			
White	<b>DP7-S-611</b>	2CKA008300A0356	1
Black	<b>DP7-S-625</b>	2CKA008300A0357	1
 <p><b>ABB-free@homeTouch 4.3"</b> For the central control of up to 16 configurable ABB-free@home® functions. For the display of configurable system messages. A configurable primary function can be triggered with a multi-touch gesture. Capacitive touch screen with closed glass surface. With integrated room temperature controller and temperature sensor. In connection with temperature sensor 6226/T the integrated room temperature controller can be fitted with a remote sensor. Suitable as room temperature controller extension unit (up to 8). Requires additional ABB power supply 24 VDC. Display size / resolution: 10.9 cm (4.3") / 480 x 854. Mounting height: 8 mm. Control element: freely programmable touch surfaces. Display elements: LCD display Bus voltage: 24 V- Dimensions: (L x W x D): 104 mm x 143 mm x 53 mm Programming only with bus voltage applied via the web interface of the System Access Point. Protection class (device): IP20 Temperature range (device): -5 °C to 40 °C</p>			
White	<b>DP4-1-611</b>	2CKA006220A0119	1
Black	<b>DP4-1-625</b>	2CKA006220A0120	1
 <p><b>Flush mounting installation box</b> For flush-mounted in hollow-wall installation of the ABB-free@homeTouch 4.3". Windproof. Installation dimensions (H x W x D): 82 mm. x 123 mm. x 50 mm. Mounting depth: 50 mm. Halogen free.</p>			
Black	<b>DP4-F</b>	2CKA006220A0389	1
 <p><b>Temperature sensor</b> For use as remote sensor with ABB- free@homeTouch 4.3". Line type: H03 VV-F Cable length: 4 m Type: NTC 10 kohm.</p>			
	<b>DP4-T-1</b>	2CKA006220A0721	1

### System Access Point



Color	Article-No.	Order-No.	Pack/Qty
 <p><b>System Access Point 2.0</b> For commissioning and remote control of the ABB-free@home® system. With integrated free@home wireless antenna. With integrated free@home bus connection. Allows the execution of astro and time programs. Commissioning and remote control is executed via the web interface or app. No additional commissioning software is required. Easy commissioning with WLAN ad-hoc mode. WLAN modes switchable via local operation. Connection to the home network via WLAN client mode or via CAT cable. The bus connection is provided via the enclosed bus terminal. Display elements: LED for status display. Rated voltage: 230 V~; 50/60 Hz. Bus voltage: 24 V. Dimensions: (L x W x D): 107 mm x 109 mm x 30 mm Programming via the web interface of the SAP. Suitable as table device or for wall mounting. 2 x USB ports for future extension of functions. 2.4 GHz and 5 GHz WLAN</p>			
	<b>SAP/S.3</b>	2CKA006200A0155	1
 <p><b>External antenna - Wireless</b> For use with System Access Point SAP-S-2 and SAP-S-127.2. Feed the free@home wireless signal to the outside when the internal antenna of the System Access Point is shielded due to structural conditions. With magnetic base. Cable length: 1.5 m.</p>			
	<b>SAP-1-WL</b>	2CKA006200A0100	1
 <p><b>Weather station</b> For recording and transmitting of brightness, temperature, wind speed and rain. Weather data can be linked with actuators to automatically control functions. Weather data can be visualized in the free@home web interface and the free@home app. Wind speed measuring range 2 - 30 m/s The bus can be connected via enclosed terminal block. Rated voltage: 110 V~ - 230 V~; 50/60 Hz. Bus voltage: 24 V- Inputs: 4 Temperature range (sensor): Brightness limit value: 1 lux - 100000 lux Dimensions: (L x W x D): 108 mm x 121 mm x 227 mm Protection class (device): IP44 Temperature range (device): -20 °C to 55 °C</p>			
	<b>WS-1</b>	2CKA006220A0390	1
 <p><b>Power supply</b> Power supply with integrated choke. Fast diagnosis due to LED display for operational readiness and errors. The bus can be connected via enclosed terminal block. Display elements: operational load/overload LED Rated voltage: 127 V~ - 230 V~, +10 % / -15 %; 50/60Hz Secondary: 30 V, +2 V / -2 V Outputs: 1 Rated current: 640 mA Protection class (device): IP20 Temperature range (device): -5 °C to 45 °C Dimensions: (L x W x D): 90 mm x 72 mm x 64 mm Module width (DIN-rail): 4 MW</p>			
	<b>PS-M-64.1.1</b>	2CDG510001R0011	1

## Zenit

### Binary inputs

Product	Article-No.	Order-No.	Pack/Qty
	<b>Binary input 2-gang</b> Conventional push-buttons or auxiliary contacts can be connected to 2 channels. The information of the contact scanning can be used for activating ABB-free@home® actuators or for recording status information. The contact polling voltage is made available from the binary input itself. Extension of the connecting cables possible by a maximum of 10 m. Flush-mounted device for installation in a 60 mm device box or distribution box. The bus can be connected via enclosed terminal block. Programming only with bus voltage applied via the web interface of the System Access Point. Bus voltage: 24 V Inputs: 2 Polling voltage: 20 V- Dimensions: (L x W x D): 39 mm x 40 mm x 12 mm.		
<b>BI-F-2.0.1</b>	2CDG510002R0011		1
	<b>Binary input 4-gang</b> Conventional push-buttons or auxiliary contacts can be connected to 4 channels. The information of the contact scanning can be used for activating ABB-free@home® actuators or for recording status information. The contact polling voltage is made available from the binary input itself. Extension of the connecting cables possible by a maximum of 10 m. Flush-mounted device for installation in a 60 mm device box or distribution box. The bus can be connected via enclosed terminal block. Programming only with bus voltage applied via the web interface of the System Access Point. Bus voltage: 24 V Inputs: 4 Polling voltage: 20 V- Dimensions: (L x W x D): 39 mm x 40 mm x 12 mm		
<b>BI-F-4.0.1</b>	2CDG510003R0011		1
	<b>Binary input 4-gang</b> The device detects AC/DC signals of 10 - 230 V via 4 channels. The information of the signal evaluation can be used for controlling ABB-free@home® actuators or for recording status information. The bus can be connected via enclosed terminal block. Programming only with bus voltage applied via the web interface of the System Access Point. Bus voltage: 24 V Inputs: 4 Module width (DIN-rail): 2 MW		
<b>BI-M-4.0.1</b>	2CDG510004R0011		1



### Switch actuators

Product	Article-No.	Order-No.	Pack/Qty
	<b>Binary input 8-gang / switch actuator 8-gang</b> With 8 binary inputs and 8 switch actuators. Zenit push-buttons or auxiliary contacts can be connected to 8 channels. These can be used for activating ABB-free@home® actuators or for recording status information. Maximum cable length at a cable cross-section of 1.5 mm <sup>2</sup> < 100 m For switching 8 independent 127/230 V~ loads. No additional commissioning software is required. Bus voltage: 24 V Inputs: 8 Polling voltage: 32 V- Outputs: 8 Normally Open contact, potential free Suitable for: AC1 (Output voltage: 230 V~) Rated current: 6 A, cos φ0.8 Suitable for: AC3 (Output voltage: 230 V~) Rated current: 6 A, cos φ0.45 Module width (DIN-rail): 8 MW.		
<b>SA-M-8.8.1</b>	2CDG510007R0011		1
	<b>Switch actuator 4-gang</b> For switching 4 independent 127/230 V~ loads. Each contact has a manual operation function independent of auxiliary voltage for additionally displaying the contact setting. Control element: relay control element. Display elements: relay control element. Power dissipation: 4 W Bus voltage: 24 V Outputs: 4 Suitable for: AC1 (Output voltage: 230 V~) Rated current: 16 A, cos φ0.8 Suitable for: AC3 Rated current: 8 A, cos φ0.45 Module width (DIN-rail): 4 MW.		
<b>SA-M-0.4.1</b>	2CDG510006R0011		1
	<b>Blind actuator 4-gang</b> Control of 4 independent blind or roller shutters. The outputs are inversely blocked. Power dissipation: 2 W Bus voltage: 24 V Outputs: 4 Suitable for: AC3 (Output voltage: 230 V~) Rated current: 6 A, cos φ0.45 Module width (DIN-rail): 4 MW.		
<b>BA-M-0.4.1</b>	2CDG510011R0011		1

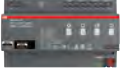

### Blind actuator

## Zenit

### Dimming actuator

Product	Article-No.	Order-No.	Pack/Qty
 <p><b>Dimming actuator 4-gang - 230Vac</b> Multi-channel universal dimming actuator for controlling LEDs, incandescent lamps, 230 V halogen lamps, low-voltage halogen lamps with conventional or electronic transformers, and dimmable energy-saving halogen lamps. For dimmable Retrofit-LEDs (LEDi). Increasing the max. load via channel bridging possible. The outputs can be switched parallel in any combination. Outputs automatically recognize the connected load. In addition, the operating mode can be selected manually. Status indication of the channels via LED. The bus can be connected via enclosed terminal block. Display elements: outputs status indication via LED. Programming only with bus voltage applied via the web interface of the System Access Point. Rated voltage: 230 V~; 50/60 Hz Bus voltage: 24 V Outputs: 4 dimming channel Suitable for: 230 V incandescent lamps and low-voltage halogen lamps with conventional transformers or electronic transformer. Rated power: 10 - 315 W/VA Suitable for: LEDi and energy-saving bulbs; typical Rated power: 2 - 80 W/VA Protection class (device): IP20 Temperature range (device): -5 °C to 45 °C Dimensions: (L x W x D): 90 mm x 144 mm x 64 mm Module width (DIN-rail): 8 MW.</p>	<b>DA-M-0.4.2</b>	2CKA006220A0395	1
 <p><b>Dimming actuator 4-gang - 127Vac</b> Multi-channel universal dimming actuator for controlling LEDs, incandescent lamps, 230 V halogen lamps, low-voltage halogen lamps with conventional or electronic transformers, and dimmable energysaving halogen lamps. For dimmable Retrofit-LEDs (LEDi). Increasing the max. load via channel bridging. The outputs can be switched parallel. Outputs automatically recognize the connected load. The operating mode can be selected manually. Status indication of the channels via LED. Display elements: outputs status indication via LED. Rated voltage: 127 V~; 50/60 Hz Bus voltage: 24 V Outputs: 4 dimming channel Suitable for: 127 V incandescent lamps and low-voltage halogen lamps with conventional transformers or electronic transformer. Rated power: 5 - 150 W/VA Suitable for: LEDi and energy-saving bulbs; typical Rated power: 2 - 40 W/VA Module width (DIN-rail): 8 MW.</p>	<b>DA-M-0.4.127.1</b>	2CKA006220A0239	1

### Heating & fan coil actuators

Product	Article-No.	Order-No.	Pack/Qty
 <p><b>Heating actuator 6-gang</b> For controlling thermoelectric actuating drives in heating/cooling systems. The outputs are protected against short-circuit and overload. The bus can be connected via enclosed terminal block. Programming only with bus voltage applied via the web interface of the System Access Point. Power dissipation: 2 W Bus voltage: 24 V Outputs: 6 Suitable for: resistive Rated current: 160 mA Module width (DIN-rail): 4 MW.</p>	<b>HA-M-0.6.1</b>	2CDG510008R0011	1
 <p><b>Heating actuator 12-gang</b> For controlling thermoelectric actuating drives in heating/cooling systems. The outputs are protected against short-circuit and overload. The bus can be connected via enclosed terminal block. Programming only with bus voltage applied via the web interface of the System Access Point. Power dissipation: 4 W Bus voltage: 24 V Outputs: 12 Suitable for: ohmic Rated current: 160 mA Module width: 8 MW.</p>	<b>HA-M-0.12.1</b>	2CDG510009R0011	1
 <p><b>Fan coil actuator</b> For controlling blower convectors. Supports 2-pipe and 4-pipe system for heating and cooling. The fan speed levels can be switched using a changeover or step switch function. Three contacts for switching a three-stage fan. Two contacts for activating the heating and cooling valves. Supports 24V and 230V valves. With two binary inputs for connecting dew-point and condensation contacts. The scanning voltage is provided by the device. The bus connection is provided via the enclosed bus terminal. Programming only with bus voltage applied via the web interface of the System Access Point. Bus voltage: 24 V Inputs: 2 Polling voltage: 10 V- Outputs: 3 Normally Open contact, potential free Suitable for: AC3 (Output voltage: 230 V~) Rated current: 6 A Module width (DIN-rail): 6 MW.</p>	<b>FCA-M-2.3.1</b>	2CDG510010R0011	1

---

## **Zenit & ABB i-bus® KNX**

### Details and solutions for intelligent building control

KNX brings your home to life. Convenient, safe and with foresight. The living room is comfortably warm on time, it stays nice and cool in the bedroom, the light matches the situation independently and the blinds adjust by themselves to the weather or time of day. Nice when comfort is easily taken for granted. With intelligent building networking from ABB.



---

**SMART BUILDING**

Rooms with intelligence. Modern building automation has become more efficient than ever in order to meet the many demands of people living and working in the building. Adaptable systems turn the modern functional building into a smart building. They create an environment in which communication and creativity can freely express themselves. Ideal for efficiency, perfect for the future

A modern office interior with large windows, a white reception desk with the number '07' in blue, and a decorative vase with a plant.

07





# Zenit KNX

## Suitable for every need

Zenit is based on a combinable concept which, creating a comprehensive range, is suitable for all needs. Optimising comfort, safety and efficiency in homes and buildings. Providing comfort solutions to satisfy all types of needs and projects. Ensuring safety and protection of persons and goods. Saving energy by using only the amount of energy required.

—  
01 Switch Sensor  
2gang KNX



—  
01

—  
02 Switch Sensor  
4gang KNX



—  
02

—  
03 Switch Sensor  
6gang KNX



—  
03

—  
04 Switch Sensor  
6gang KNX with IR



—  
04

—  
05 Busch-Watchdog  
180° KNX



—  
05

—  
06 Room Thermostat  
KNX



—  
06



Zenit offers two different mounting plates for KNX sensors, corresponding to different market standards: Square boxes with 60 mm. distance between screws and rectangular boxes with 83,5 mm. distance between screws.



- **Multiple functions:** switching, dimming, blinds sending values, scenes, etc.
- **Incl. 10 logic channels**
- **Sequence actuator**
- **Logic gates**
- **Control element:** switch contacts
- **Display elements:** LED to indicate the function

---

**SMART BUILDING**



The perfect connection. A pleasant and productive environment is created with building automation that functions as a holistic system and combines various functions. For today and tomorrow







## Zenit

### Sensors

Product	Article-No.	Order-No.	Pack/Qty
 <p><b>KNX sensor - 1/2-gang - 2M</b> For ABB i-bus® KNX. Support of KNX functions through innovative colour concept (yellow=lighting, blue=blind, orange=RTC, magenta=scene and white=neutral/no function assigned) or standard illumination red/green. The accompanying symbol can be replaced by the symbols for lighting, blinds, room thermostat, scene and FanCoil. Push switch function: switching / dimming / blind / sending values / scenes etc. Incl. 10 logic channels (light scene actuator, sequence actuator, logic gates, etc.). Control element: Switch contacts. Display elements: LED to indicate the function. Temperature range (Device): -5 °C to 45 °C. To be installed with N2221.2 cover plates.</p>	6125/98-509	2CKA006115A0444	1
 <p><b>KNX sensor - 2/4-gang - 2M</b> For ABB i-bus® KNX. Support of KNX functions through innovative colour concept (yellow=lighting, blue=blind, orange=RTC, magenta=scene and white=neutral/no function assigned) or standard illumination red/green. The accompanying symbol can be replaced by the symbols for lighting, blinds, room thermostat, scene and FanCoil. Push switch function: switching / dimming / blind / sending values / scenes etc. Incl. 10 logic channels (light scene actuator, sequence actuator, logic gates, etc.). Control element: Switch contacts. Display elements: LED to indicate the function. Temperature range (Device): -5 °C to 45 °C. To be installed with N2221.4 cover plates.</p>	6126/98-509	2CKA006116A0219	1
 <p><b>KNX sensor - 3/6-gang - 2M</b> For ABB i-bus® KNX. Support of KNX functions through innovative colour concept (yellow=lighting, blue=blind, orange=RTC, magenta=scene and white=neutral/no function assigned) or standard illumination red/green. The accompanying symbol can be replaced by the symbols for lighting, blinds, room thermostat, scene and FanCoil. Push switch function: switching / dimming / blind / sending values / scenes etc. Incl. 10 logic channels (light scene actuator, sequence actuator, logic gates, etc.). Control element: Switch contacts. Display elements: LED to indicate the function. Temperature range (Device): -5 °C to 45 °C. To be installed with N2221.6 cover plates.</p>	6129/96-509	2CKA006118A0105	1

Product	Article-No.	Order-No.	Pack/Qty
 <p><b>KNX sensor - 3/6-gang with IR receiver - 2M</b> For ABB i-bus® KNX. Support of KNX functions through innovative colour concept (yellow=lighting, blue=blind, orange=RTC, magenta=scene and white=neutral/no function assigned) or standard illumination red/green. The accompanying symbol can be replaced by the symbols for lighting, blinds, room thermostat, scene and FanCoil. Push switch function: switching / dimming / blind / sending values / scenes etc. Incl. 10 logic channels (light scene actuator, sequence actuator, logic gates, etc.). Control element: Switch contacts. Display elements: LED to indicate the function. Temperature range (Device): -5 °C to 45 °C. To be installed with N2221.7 cover plates.</p>	6129/98-509	2CKA006118A0108	1
 <p><b>KNX room temperature controller - 2M</b> For ABB i-bus® KNX. Control element with room thermostat function for triggering the heating, ventilation and fan-coil actuators. The controller is a thermostat for Fan Coil units in 2- and 4-pipe systems and conventional heating or cooling systems. The fan stage can be switched manually or in automatic mode. Incl. 10 logic channels (light scene actuator, sequence actuator, logic gates, etc.). Switch contacts for operating mode selection and dial for setpoint or fan speed adjustment. Display elements: LCD showing operation modes. Temperature range (Device): -5 °C to 45 °C. To be installed with N2240.4 cover plates.</p>	6124/98-509	2CKA006134A0297	1
 <p><b>KNX 180° motion sensor - 2M</b> For ABB i-bus® KNX. Movement detector with up to 4 channels. Protection class (Device): IP 20. Temperature range (Device): -5 °C to 45 °C. Detection range: frontal: 6 m, lateral: 6 m. Brightness limit value: 5 Lux - 150 Lux. Detection angle: 180 ° Dimensions: (L x W x D): 53 mm x 44 mm. Position for installation: vertical. Mounting height: 1.1 m. To be installed with N2241.4 cover plates.</p>	6122/98-509	2CKA006132A0307	1

## Room temperature controller

## Motion sensor

## Zenit

### Covers for sensors

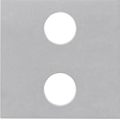
Color	Article-No.	Order-No.	Pack/Qty
 <p><b>Cover plate - KNX 1/2-gang sensors - 2M</b> Cover plate for KNX sensors 1/2-gang code: 6125/98-509.</p>			
White	<b>N2221.2 BL</b>	2CLA222120N1102	1
Silver	<b>N2221.2 PL</b>	2CLA222120N1302	1
Anthracite	<b>N2221.2 AN</b>	2CLA222120N1802	1
Champagne	<b>N2221.2 CV</b>	2CLA222120N1902	1

 <p><b>Cover plate - KNX 2/4-gang sensors - 2M</b> Cover plate for KNX sensors 2/4-gang code: 6126/98-509.</p>			
White	<b>N2221.4 BL</b>	2CLA222140N1102	1
Silver	<b>N2221.4 PL</b>	2CLA222140N1302	1
Anthracite	<b>N2221.4 AN</b>	2CLA222140N1802	1
Champagne	<b>N2221.4 CV</b>	2CLA222140N1902	1

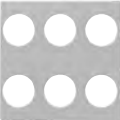
 <p><b>Cover plate - KNX 3-gang sensors - 2M</b> Cover plate for KNX sensors 3/6-gang code: 6129/96-509.</p>			
White	<b>N2221.6 BL</b>	2CLA222160N1102	1
Silver	<b>N2221.6 PL</b>	2CLA222160N1302	1
Anthracite	<b>N2221.6 AN</b>	2CLA222160N1802	1
Champagne	<b>N2221.6 CV</b>	2CLA222160N1902	1

 <p><b>Cover plate - KNX 3-gang sensors with IR - 2M</b> Cover plate for KNX sensors 3/6-gang with IR receiver code: 6129/98-509.</p>			
White	<b>N2221.7 BL</b>	2CLA222170N1102	1
Silver	<b>N2221.7 PL</b>	2CLA222170N1302	1
Anthracite	<b>N2221.7 AN</b>	2CLA222170N1802	1
Champagne	<b>N2221.7 CV</b>	2CLA222170N1902	1

Color	Article-No.	Order-No.	Pack/Qty
 <p><b>Cover plate - KNX RTC - 2M</b> Cover plate for KNX RTC sensors code: 6124/98-509.</p>			
White	<b>N2240.4 BL</b>	2CLA224040N1102	1
Silver	<b>N2240.4 PL</b>	2CLA224040N1302	1
Anthracite	<b>N2240.4 AN</b>	2CLA224040N1802	1
Champagne	<b>N2240.4 CV</b>	2CLA224040N1902	1

 <p><b>Cover plate - KNX RTC - 2M</b> Cover plate for KNX RTC sensors code: 6124/98-509.</p>			
White	<b>N2241.4 BL</b>	2CLA224140N1102	1
Silver	<b>N2241.4 PL</b>	2CLA224140N1302	1
Anthracite	<b>N2241.4 AN</b>	2CLA224140N1802	1
Champagne	<b>N2241.4 CV</b>	2CLA224140N1902	1

### Buttons with symbols



#### KNX button with symbol

Button with ABB i-bus® KNX symbol for sensor's cover plates code: N2221.2, N2221.4, N2221.6 and N2221.7.

- 6123/20-500: light symbol.
- 6123/21-500: blind symbol.
- 6123/22-500: scene symbol.
- 6123/23-500: RTC symbol.
- 6123/24-500: ceiling light symbol.
- 6123/26-500: fan coil symbol.

Gray	<b>6123/20-500</b>	2CKA006123A0001	1
Gray	<b>6123/21-500</b>	2CKA006123A0002	1
Gray	<b>6123/22-500</b>	2CKA006123A0003	1
Gray	<b>6123/23-500</b>	2CKA006123A0004	1
Gray	<b>6123/24-500</b>	2CKA006123A0005	1
Gray	<b>6123/26-500</b>	2CKA006123A0006	1

DIAGRAMS & DIMENSIONS

Thinking of making your job easier. We create these supports to optimize your time. We provide all the technical information, diagrams and dimensions of each of our products in a clear and precise manner to facilitate understanding.

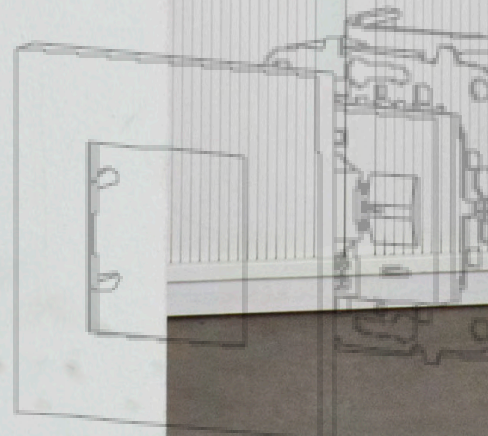
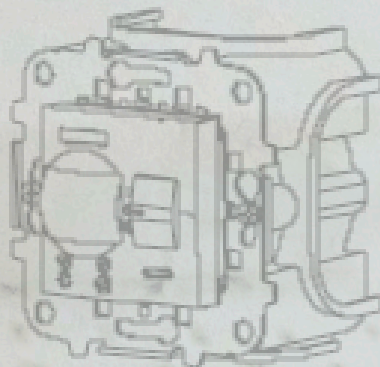
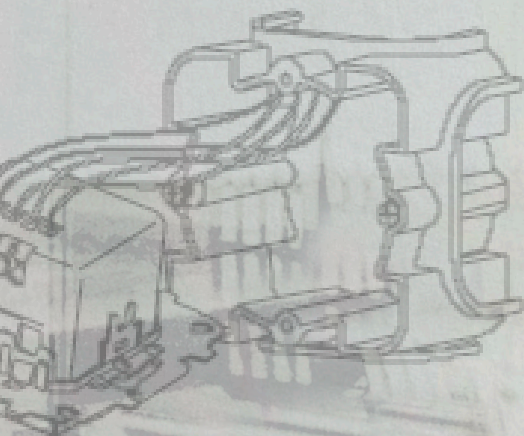
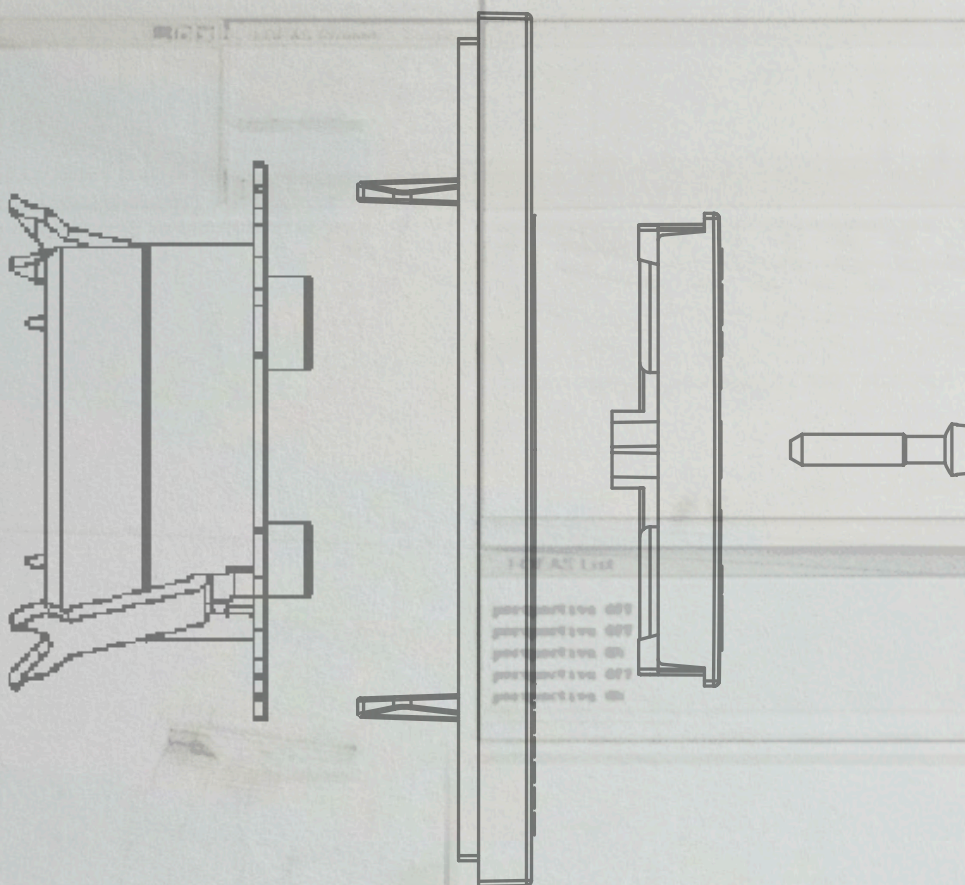





## Switches

Optional: locator light

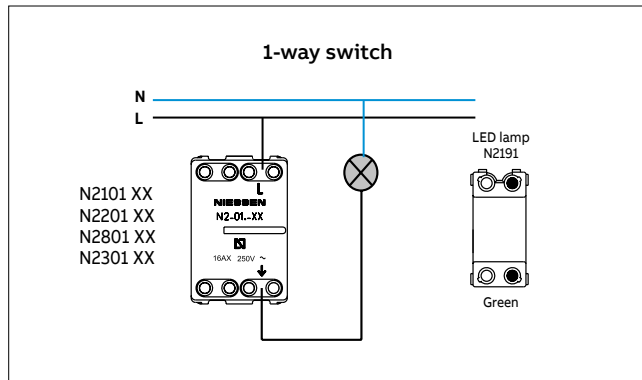

With indicator light

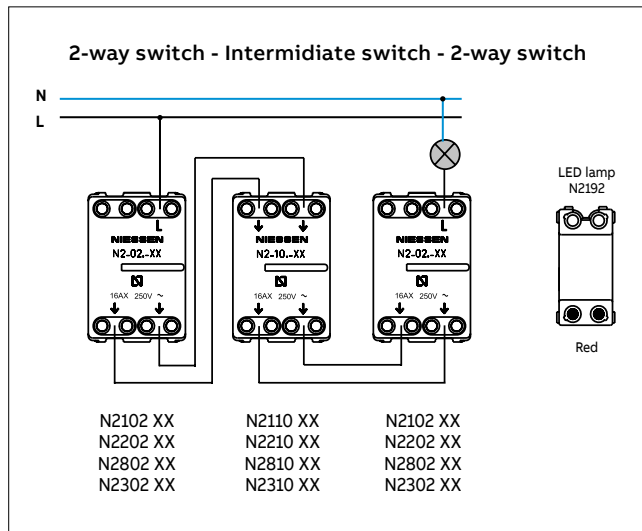
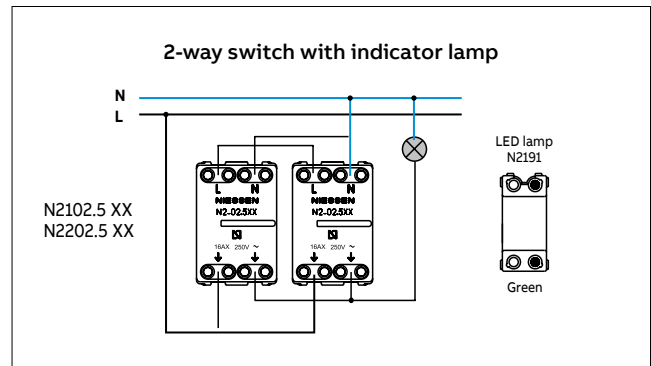
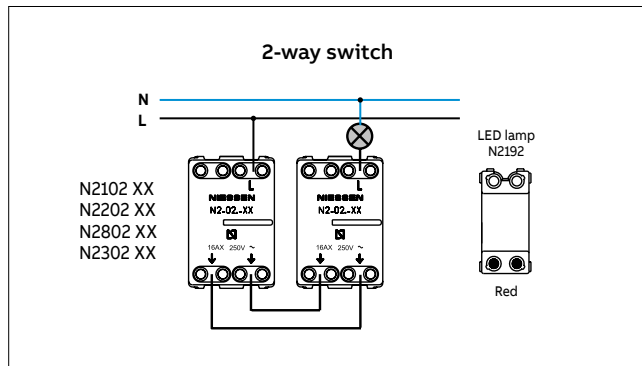
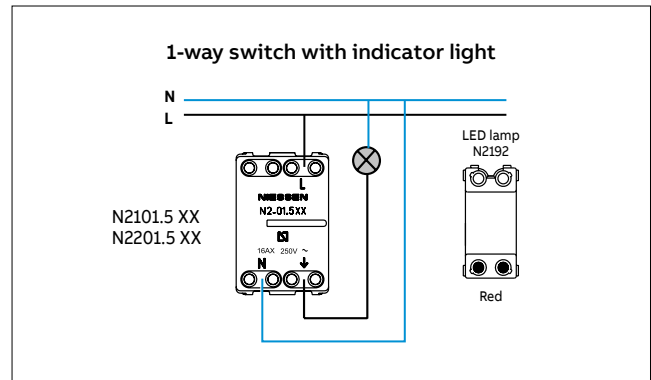

## Push-buttons

Optional: locator light

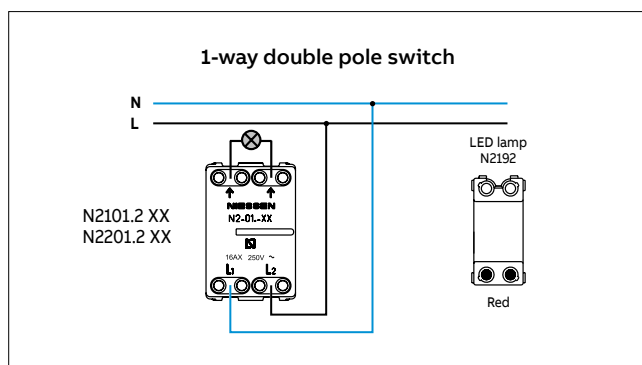
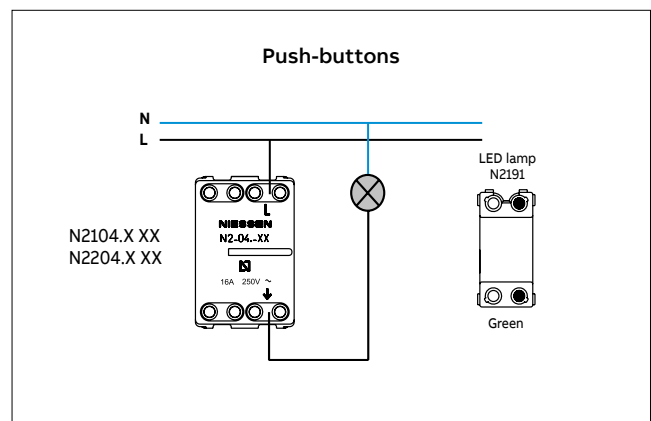

## Push-buttons

With locator or indicator light

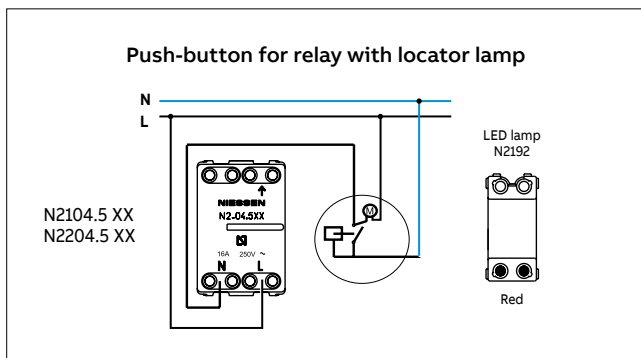
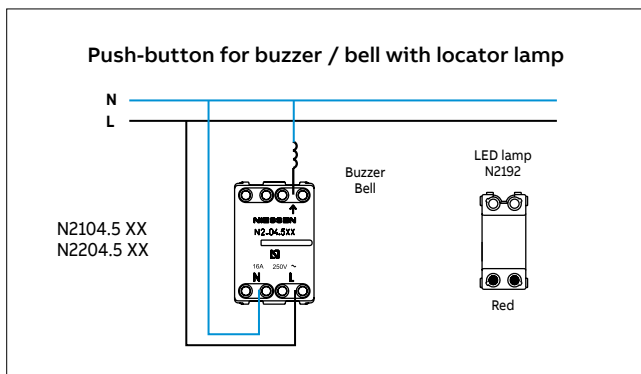
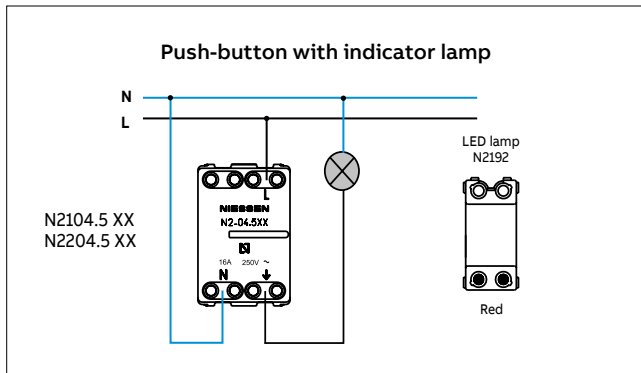

## Card switch

With locator light

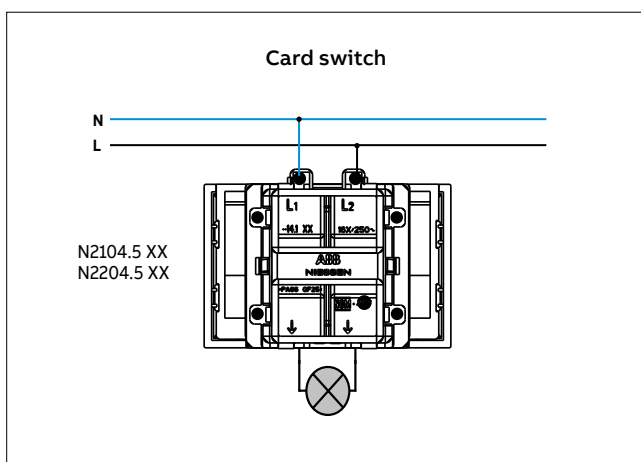

## Card timer switch

With locator light

**1- Technical Data**

**Power Supply:** 127 V~ / 60 Hz  
230 V~ / 50 Hz

**Night orientation:** By a red LED  
**Operating T°:** 0° C +40° C

Maximum power:  
127 V~ / 60 Hz:  
⊗1600 W, ⊞1600 W, ⊚1600 W, ⊙1600 W, ⇐700 W  
230 V~ / 50 Hz:  
⊗3000 W, ⊞3000 W, ⊚3000 W, ⊙1600 W, ⇐1300 W

**2.- Mounting and connection scheme**

**2.1.- Mounting**

**2.2.- Connection**

**Important: Disconnect the electrical power when installing.**

**3.- Operation**

**Time selector for disconnection:** The load time disconnection, after removing the card, can be programmed by the user through the rotary programme selector on the device cover.

Option	Time until disconnection		Previous status	Current Status	Action
	50Hz	60Hz			
1.-	5 s.	4 s.	No card	Card detected	Connects load
2.-	10 s.	8 s.			
3.-	20 s.	16 s.			
4.-	30 s.	25 s.	Card detected	No card	Disconnects the load at preset time
5.-	60 s.	50 s.			
6.-	90 s.	75 s.			

## Blind switch & push-button

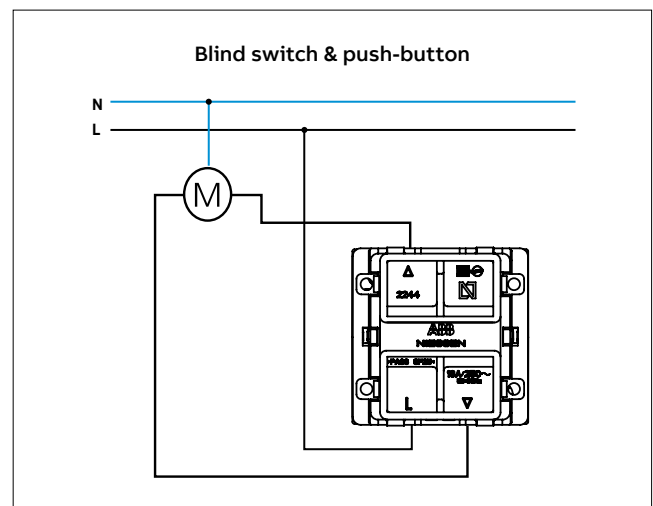

# Electronic blind switch

## N2261.2

**Technical data:**

- Power Supply: 230V~ 50Hz / 127V~ 60Hz
- Maximum power:
  - 230V~ 50Hz blind motors: 2x 700VA persianas (cos  $\psi = 0,5$ )
  - 127V~ 60Hz blind motors: 2x 350VA persianas (cos  $\psi = 0,5$ )
- Room temperature for operation: 0°C to 40°C
- According to: UNE-21806 y EN-55014

**Functional features:**

The electronic blind switch includes 3 modes of operation (to be selected in the rotatory switch):

- P: standard blinds control. Optionally other N2244 inserts can be connected to the N2261.2 to control the blind from other locations.
- V: venetian type blinds control. Optionally other N2244 inserts can be connected to the N2261.2 to control the blind from other locations.
- C: centralization. One N2261.2 can control all the N2261.2 centrally.



**Wiring diagram:**

- Direct blind control with a N2261.2 (Fig. 1).
- Remote control of the N2261.2 electronic blind control by using a blind push-button N2244 (Fig. 2).
- Centralized control of all the blind from one point by using a electronic blind switch N2261.2 as master of the rest electronic blind switches N2261.2 (Fig. 3).

Fig. 1

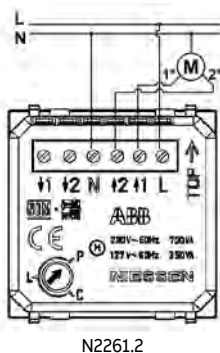

Fig. 2

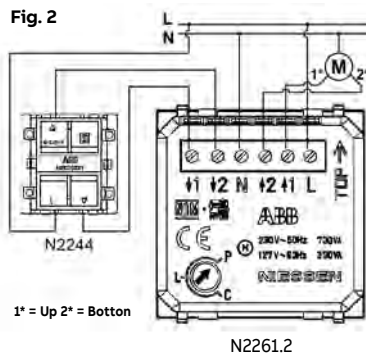
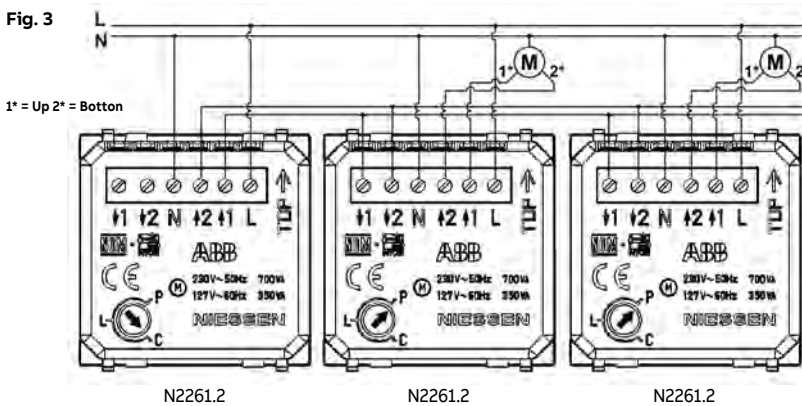

Fig. 3



**Mounting:**

Follow the steps below to install the mechanism:

1. Connect the device according to the connection schemes. Figure 1, 2 or 3.
2. Assemble the device on the flush mounting box.
3. Then, place the plate.

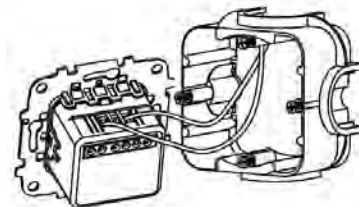

1.

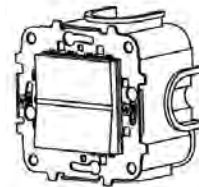

2.

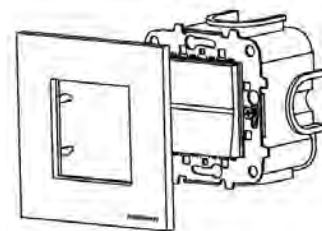

3.

Operation:		Blind operating mode.	Slats or Venetian blinds operating mode.	Centralized operating mode.
Pulsation	Action	Action	Action	Action
Short pulsation ▲ < 300ms	It raises the blind (3 min.), which was previously stationary. It stops the blind, which was previously moving.	It raises the blind (3 min.) which was previously stationary. It stops the blind, which was previously moving.	It raises the blinds (of those inserts connected), which were previously stationary. It stops the blinds, which were previously moving.	
Short pulsation ▼ > 300ms	It lowers the blind (3 min.), which was previously stationary. It stops the blind, which was previously moving.	It lowers the blind (3 min.), which was previously stationary. It stops the blind, which was previously moving.	It lowers the blinds (of those inserts connected), which were previously stationary. It stops the blinds, which were previously moving.	
Long pulsation ▲ < 300ms	Raises the blind while the pulsation lasts, which was previously stationary. It stops the blind, which was previously moving.	The slats rotates upwards in a pulsed way while the pulsation lasts, if the blind was previously stationary. If the pulsation lasts longer, the blind will raise for as long as the pulsation lasts. It stops the blind, which was previously moving.	It raises the blinds (of those connected mechanisms), which were previously stationary. It stops the blinds, which were previously moving.	
Long pulsation ▼ > 300ms	It lowers the blind while the pulsation lasts, if it was previously stationary. It stops the blind, which was previously moving.	The slats rotates downwards in a pulsed way while the pulsation lasts, if the blind was previously stationary. If the pulsation lasts longer, the blind will raise for as long as the pulsation lasts. It stops the blind, which was previously moving.	It lowers the blinds (of those connected mechanisms), which were previously stationary. It stops the blinds, which were previously moving.	

## Key switches

2-way / 3 positions

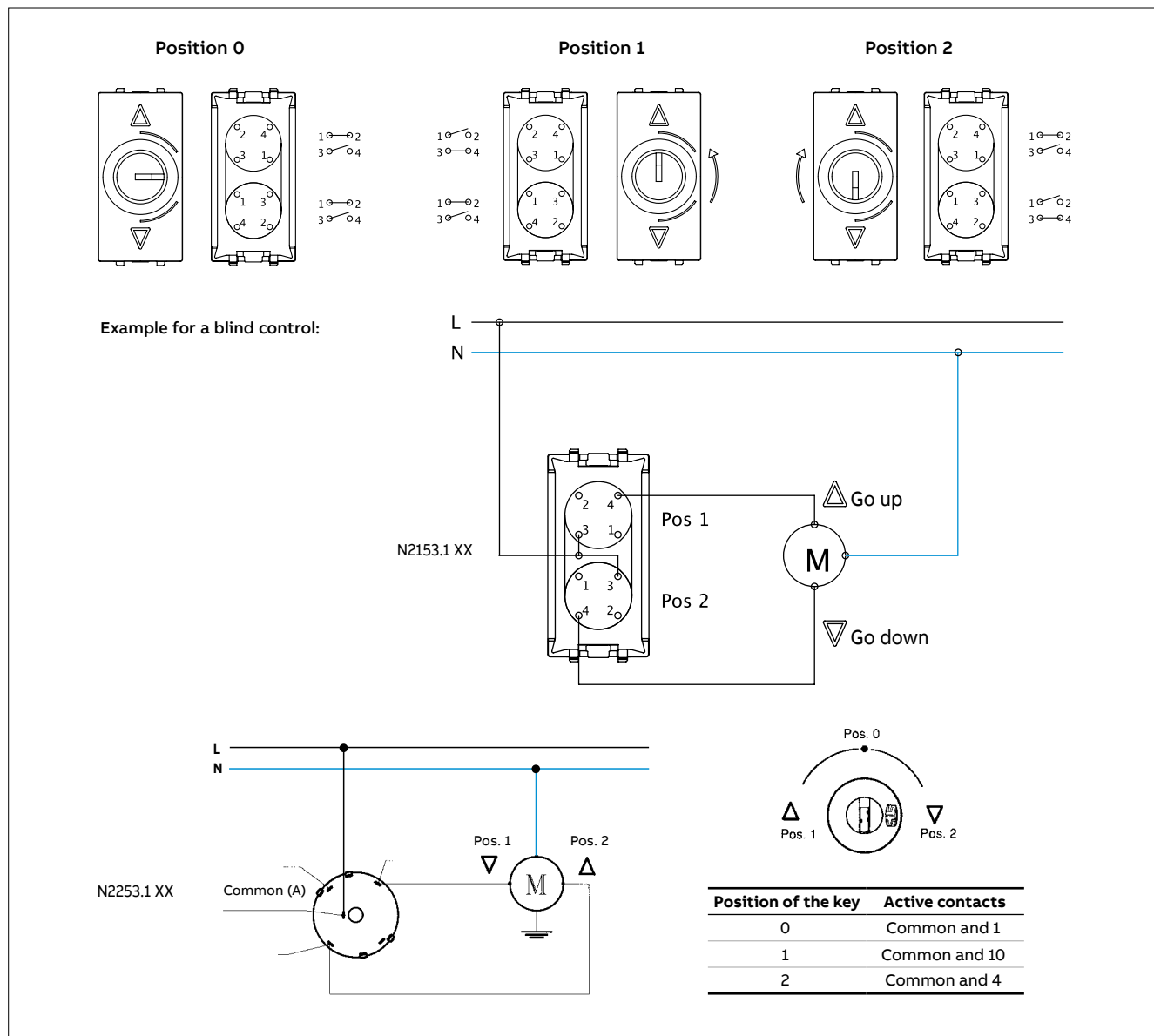

## Key switches & push-buttons

1 or 2-way / 2 positions

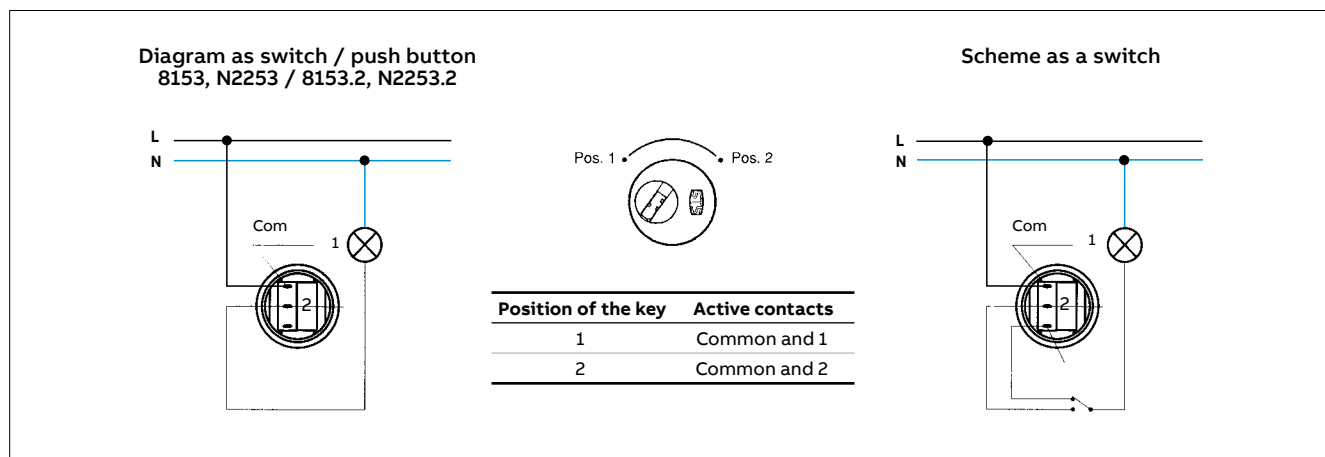

## USB chargers

N2185, N2285 & N2185.2

### 1. Technical data:

**Rated input voltage:**  
100 - 240 V AC  $\pm$  10 %

**Rated input frequency:**  
50 - 60 Hz

**Rated input current:**  
N2185.2: 0,20Aac@max load  
N2285: 0,20Aac@max load  
N2185: 0,12Aac@max load

**Consumption in standby:**  
N2185.2: <10 mW@230 VAC  
N2185 & N2285 : <= 0,3W@230 VAC

**Rated output voltage:**  
5 V DC  $\pm$  5 / -5 %

**Rated output current:**  
N2185.2: 2000 mA a 5 V DC  
N2285: 1500 mA a 5 V DC  
N2185: 750 mA a 5 V DC

**Operating temperature:**  
N2185.2: 0°C to 45°C, when installing  
a N2185.2. 0°C to 30°C, when two  
N2185.2 chargers together  
N2285: 0° C + 35° C  
N2185: 0° C + 45° C

**Energy efficiency:**  
N2185.2: > 79%  
N2285: >= 71%  
N2185: >= 66%

### 2. Electrical safety data:

**Safety standard:**  
EN60950-I - Low Voltage Directive

**Protection class:**  
II - Low voltage

**Isolation (primary-secondary):**  
Transformer with galvanised isolation

**EMC Directive:**  
EN 55022, EN 55024

### 3. Wiring diagram:

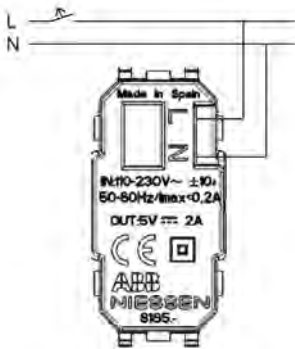

### 4. Installation

N2185.2 & N2185

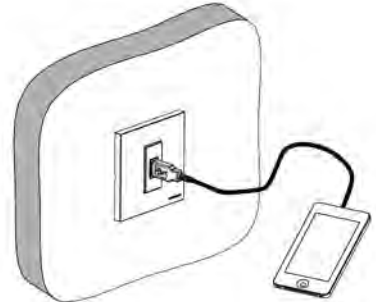
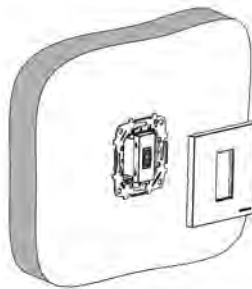
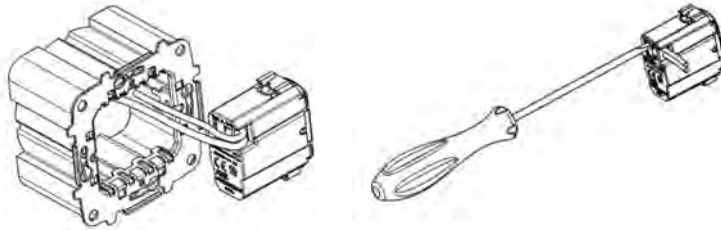

N2285

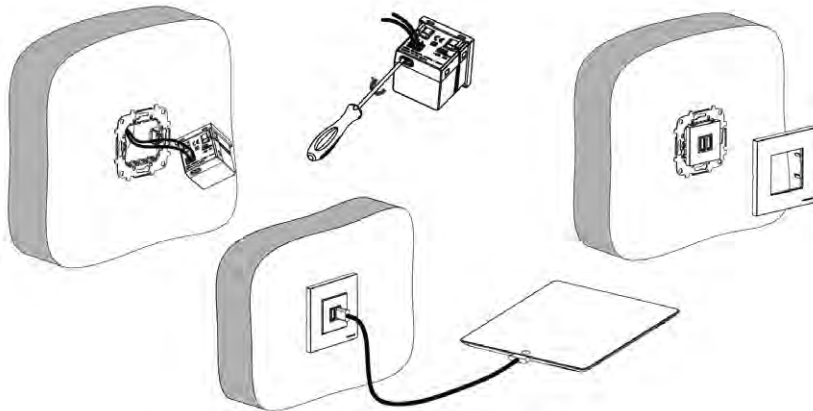

## Circuit breaker 6/10/16A & RCD

N2234.1, N2234.2 & N2234.3

### 1.- Technical data:

#### Rated voltage:

120 - 230 Vac

#### Rated frequency:

50 - 60 Hz

#### Rated current (In):

N2234.1: 6 Aac

N2234.2: 10 Aac

N2234.3: 16 Aac

#### Breaking capacity:

N2234.1: 1,5 kA

N2234.2 & N2234.3: 3 kA

#### Residual current (sensitivity) - I $\Delta$ n:

10 mA

#### Magneto-thermic action:

C type (see diagram)

#### Number of poles:

Two-pole (1P + N) with 1 protected pole

### 2.- Standards:

EN 61009 / 1 / 1994

EN 61009 / 2 / 1 / 1994

IEC 1009 / 2 / 2 / 1991

IEC 1009 / 1 Amd 1 1995

#### Low Voltage Directive:

CEE 73/23 & 93/66 CEE

#### EMC Directive:

CEE89/336, 92/31 CEE & 93/68 EEC

### 3.- Wiring diagram:

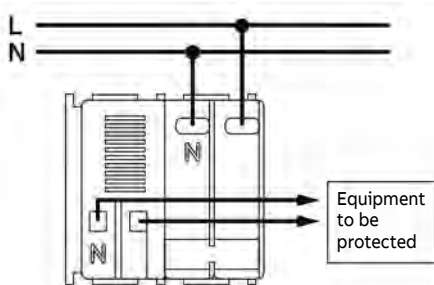

### 4.- Installation

1. Fix the plastic support in the mounting plate.
2. Insert the mechanism in the mounting plate from the rear side.
3. Place the cover plate.

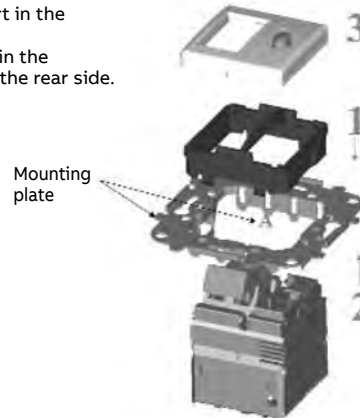

### 4.- Current-Time tripping diagram

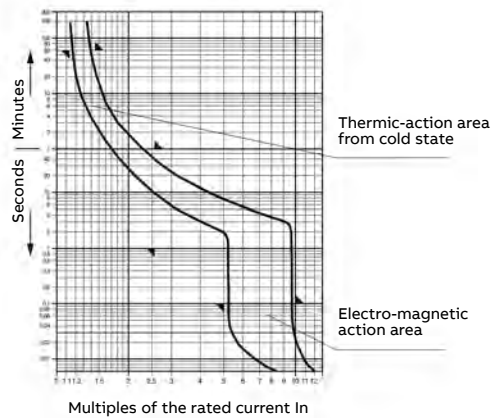

## TV / R outlets

### Technical data

- Connection: Screw terminal and clamp. Coaxial cable 75 ohm.
- Shielded zamak and metal plate chassis.
- In conformity with EN 50083-1:1993, EN 50083-2:2001, EN 61000-6-1:2001, EN 61000-4-2:1995 ESD 15KV AD, 8KV CD, EN50083-4:1998
- Fits in a Ø60 mm box.

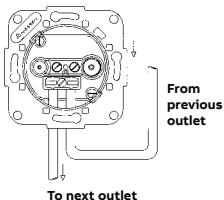

**Important:** the connection of the TV outlets in serial distribution must be carried out according to the figure on the left. The cable coming from the previous outlet is connected in the right terminal and the cable going to the next outlet in the left terminal.

Code		8150	8150.3	8150.7	8150.8	
Installation		Final		Intermediate		
Connection		Screw terminal and clamp				
Output connectors	C1	IEC male Ø 9.52 mm				
	C2	IEC female Ø 9.52 mm				
Frequency range	I/O	5 - 862		13 - 862	5 - 862	
	MHz	C1 5 - 862 C2 5 - 862	5-88/118-862 87.5 - 108	13 - 862	5 - 862	
Basic loss	dB ±TOL	FM	10,0 ±0,7	1,1 ±0,3	25,0 ±1,5	30,0 ±0,2
		DAB	10,0 ±1,5	R: 0,3 ±0,1	25,0 ±1,5	30,0 ±0,2
		VHF	4,0 ±1,5	TV: 0,9 ±0,3	8,0 ±0,7	11,0 ±1,0
		UHF	3,0 ±0,5		8,0 ±0,7	10,5 ±1,0
Through loss	dB ±TOL	FM	-	2,0 ±0,3	1,0 ±0,2	
		VHF	-	2,0 ±0,5	1,1 ±0,3	
		UHF	-	2,0 ±0,5	1,3 ±0,4	
Directivity	dB	FM	-	>12	>25	
		TV	-	>9	>13	
Isolation	dB	FM	>14	>18	>16	
		TV	>14	>16	>15	
Return loss	dB	FM	>18	>16	>12	
		TV	>10	>18	>12	

**Note:** reference 8150.3 compatible with CATV

### MATV connection diagram Distribution with tap-off units

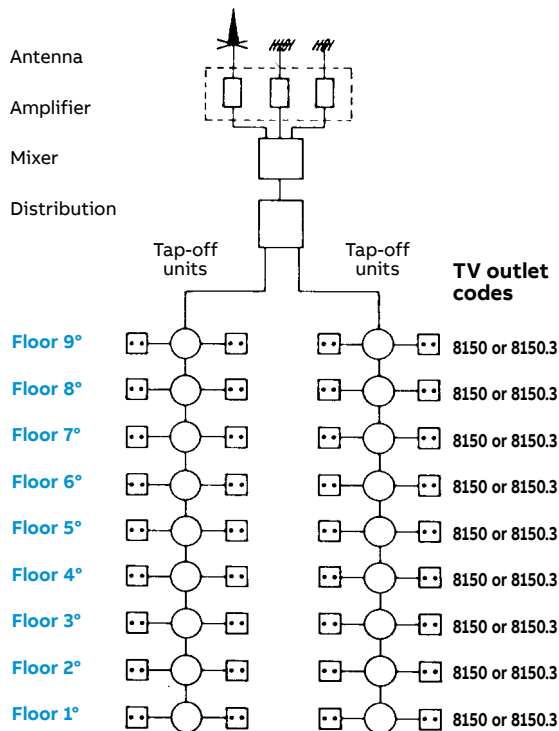

In this diagram all final outlets are the same. References 8150 or 8150.3 can be used equally.

### MATV connection diagram Serial distribution up to 9 floors

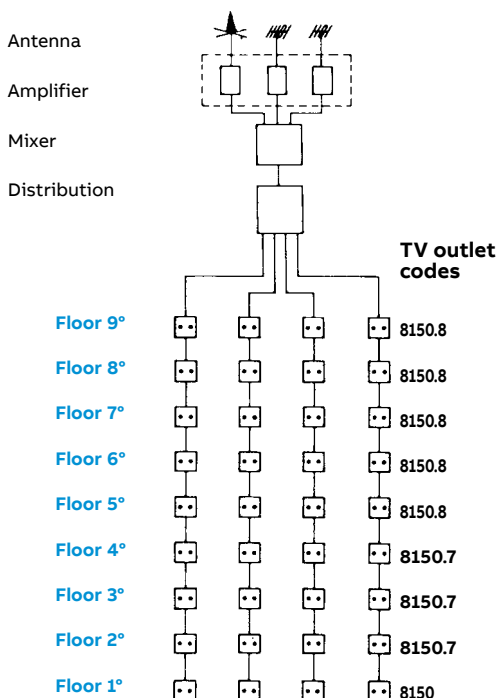

### MATV connection diagram Serial distribution for more than 9 floors

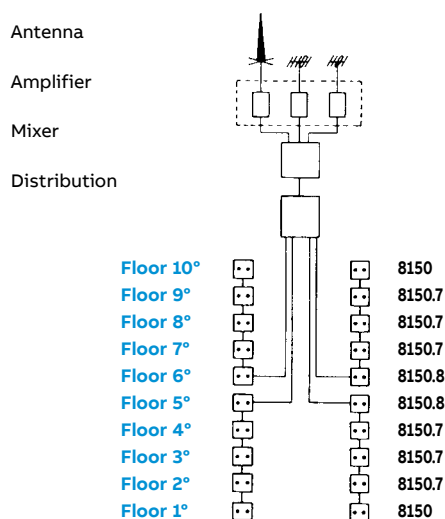

**Example:** 10 floors. The floors are divided in 2 groups of 5 floors each. The outlets are distributed according to the criteria shown in the MATV connection diagram for serial distribution up to 9 floors. The diagram above can be used in buildings up to 18 floors. For buildings with more than 18 floors and up to 27 floors, 3 groups have to be created and so on.



## Tomas de TV-R / SAT

### SMATV connection diagram

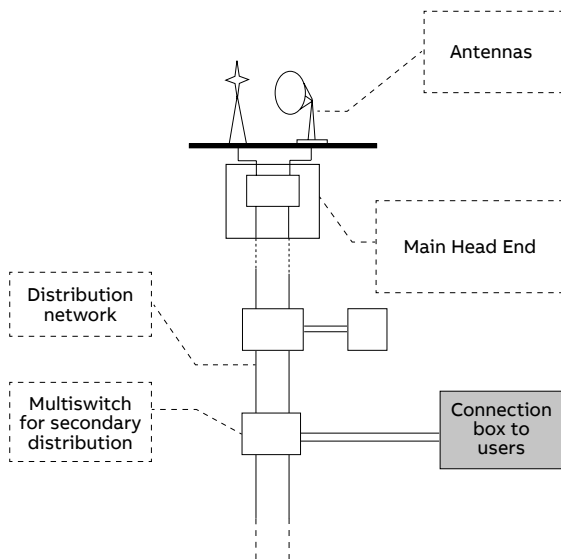

#### Note:

End of line impedance. If the distribution equipment requires outlets with end of line resistors, 8151.7/N2251.7 outlets must be used or add to 8151.3/N2251.3 outlets a termination resistor to close the line.

#### a) SMATV star connection diagram

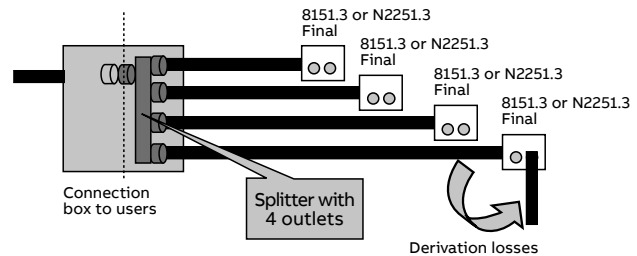

#### a) SMATV star connection diagram

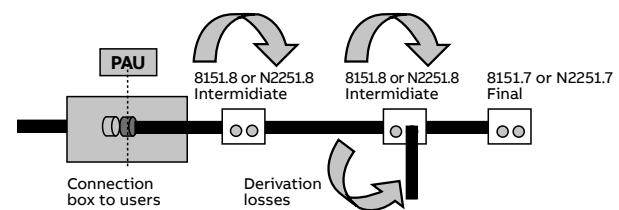

#### Note:

It is recommended to avoid installing more than 2 intermediate outlets per line.

Code		8151.3 N2251.3	8151.7 N2251.7	8151.8 N2251.8	8152.7	
Installation		Final		Intermediate	Final	
Connection		Screw terminal and clamp				
Output connectors	C1	IEC male Ø 9.52 mm				
	C2	IEC female Ø 9.52 mm				
	C3	-			F female	
Frequency range	MHz	E/S	5 - 2400	5 - 2400	5 - 2500	
		C1	5 - 862	5 - 2400	5 - 68 / 125 - 862	
		C2	930 - 2400	5 - 2400	87,5 - 108	
		C3		-	950 - 2500	
Basic loss	dB ±TOL	FM	0,2 ±0,1	3,7 ±0,3	10,0 ±1,0	2,0
		TV	1,0 ±0,5	4,0 ±0,5	10,0 ±1,0	2,7
		SAT	1,2 ±0,6	5,0 ±1,2	12,0 ±2,0	2,3
Through loss	dB ±0,5	FM	-	-	2,5 ±0,5	-
		TV	-	-	2,5 ±0,7	-
		SAT	-	-	3,0 ±1,0	-
Directivity	dB	FM	-	-	>20,0	-
		TV	-	-	>12,0	-
		SAT	-	-	>5,0	-
Isolation	dB	FM	>45	>20	>45	>24,3
		TV	>14	>20	>30	>15
		SAT	>14	>14	>28	>15
Selectivity	dB	FM	-	-	-	>15
		TV-R	>15	>15	-	>15
		SAT	>15	>15	-	>15
Return loss	dB	VR	>25	>16	>13	>7,6
		FM	>25	>16	>13	>10
		TV	>14	>16	>12	>7,6
		SAT	>10	>9	>12	>8,2
DC path	V <sub>m</sub>	24 max			24 max	
	mA	500 max			500 max	
	Tono	22 KHz/DiSEqC			22 KHz/DiSEqC	

### N2250.X & N2252 covers for TV outlets

1. In some cases the TV outlets have too small holes for frame's clamps.

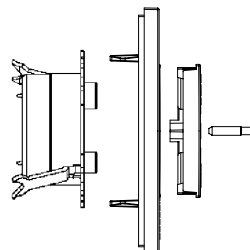
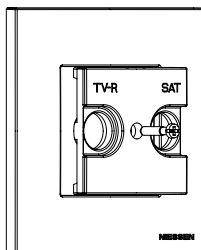
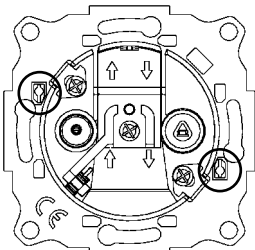

2. There are two options of mounting the cover plates: a) cut the clamps that are facing the small holes.

b) Cut all the clamps of the frame.

3. When the cover plate is screwed to the insert, the 4 parts that stick out from the cover, will fix the frame to the wall.

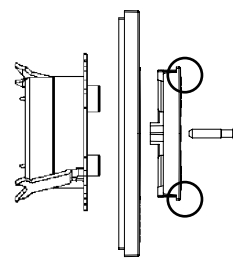
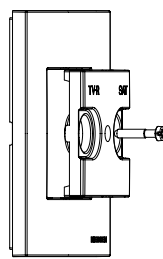
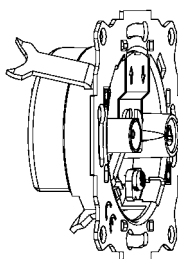
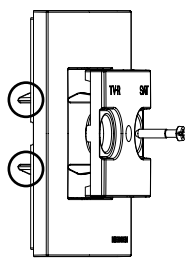
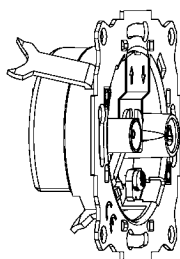

### N2251.3 TV-R/SAT outlet single, N2251.7 TV-R/SAT outlet dead-end and N2251.8 TV-R/SAT outlet loop through

#### Mounting diagram

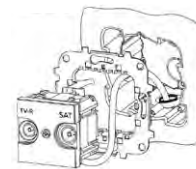
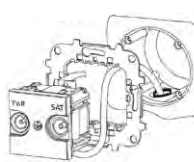
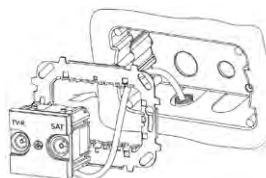
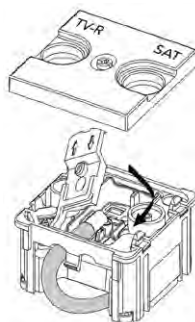
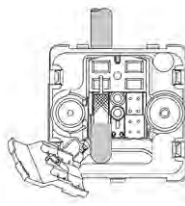
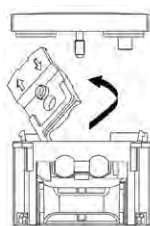

#### Cable to use

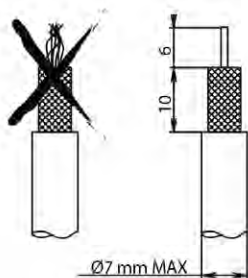

#### Cable to use

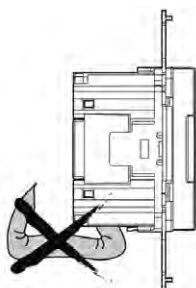

- Use coaxial cable with 75Ω impedance.

- Avoid small bending radius.

## N2150.7 & N2250.7 - TV outlet dead-end

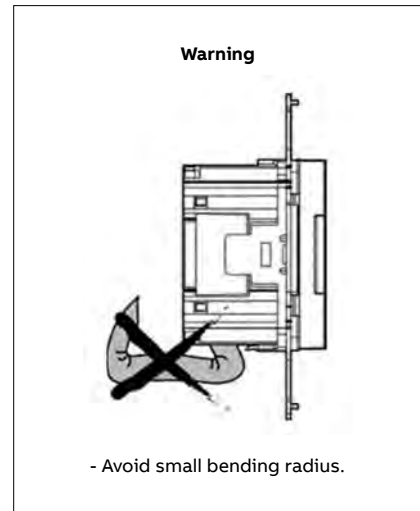
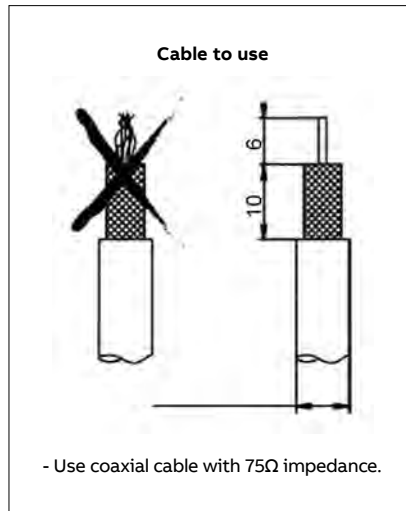
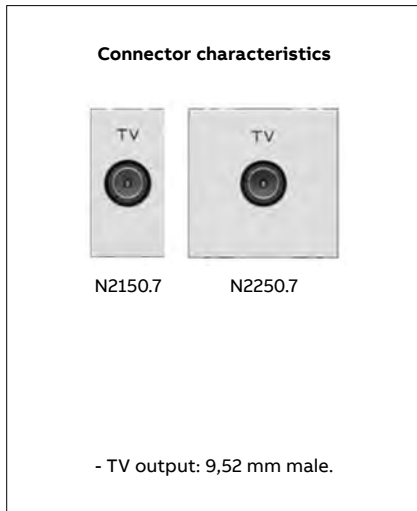

Name		TV outlet dead-end	
Frequency range	MHz	TV	5 - 2400
Connection loss	dB	TV	1
Isolation	dB	TV	>16
Return loss	dB	TV	>7,6
Bypass DC current	V mA		34 (max.) 500 (max.) 22Khz / DiSEqC

## Telephone outlets

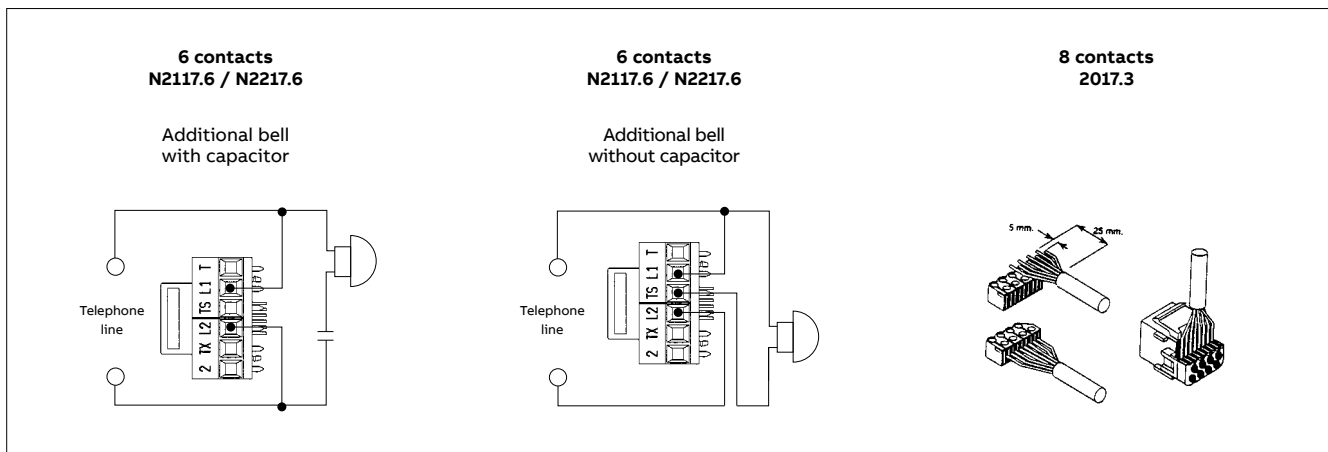

# RJ45 Cat. 6 female connector

2018.6

## 1 Preparing the Cable

1.1 Cut approximately 5 cm. off the jacket.



1.2 Open approx. 10 cm. of the jacket with a cutter cord or another tool.

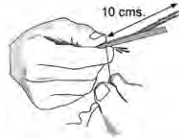

1.3 Cut the jacket.



1.4 Cut the mesh (if it has one and the cord at the same level of the jacket).



## 2 Preparing the Conductors

2.1 Select the adequate wiring scheme (568A or 568B) and place the pairs in a straight line.

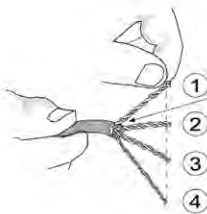

**Important Note:**  
Do not cross the pairs over one another!  
First, arrange/position pairs 1 and 4, and then pairs 2 and 3 in their usual line.

1	2	3	4
568A: Az Ma Ve Na			
568B: Az Ma Na Ve			

2.2 Position each of the four pairs in the holes of the end piece.

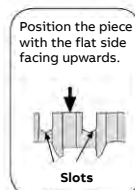

2.3 Ensure the end piece is located as close as possible to the edge of the jacket.

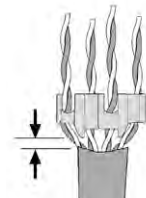

2.4 Place the pairs in the direction of the end piece slots.

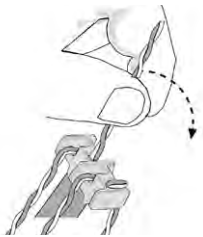

2.5 Insert the end piece into the module.

Blue / White (first pair)

**Important Note:** Align the Blue / White pair with the Blue / White colour indicated in the module colour code.

Check the orientation of the colour codes: Blue / White matched with Blue / White

Position the piece with the flat side facing upwards.

2.6 Unbraid the pairs, position and insert the cable in the module slots. Place the **solid colour cable in the first slot of the pair.**

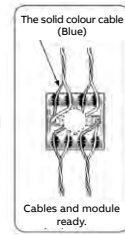
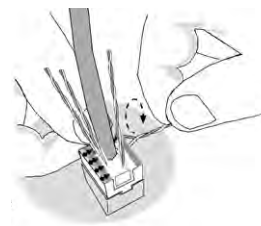

## 3 Conductor Terminations

3.1 Place the tool perpendicular to the module and finish cutting the cables.

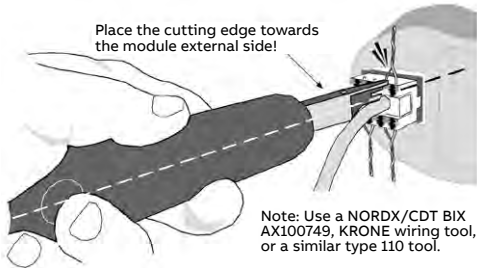

Note: Use a NORDX/CDT BIX AX100749, KRONE wiring tool, or a similar type 110 tool.

## 4 Placing the Cable

4.1 Place the cable in the upper, perpendicular, or lower position so that it is easy to insert the module in the box for attachment.

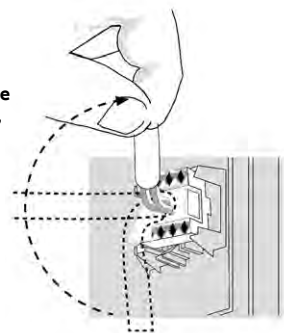

## 5 Disassembling the module from the supporting piece

5.1 Push the front of the module in with your thumb releasing the hooks.

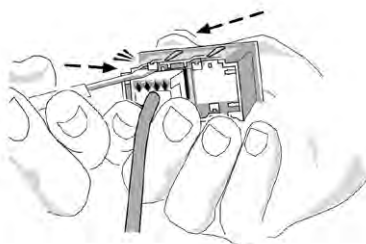
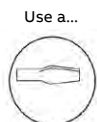

5.2 Pry upwards to release the upper hook.



5.3 Pry downwards to release the lower hook.



## RJ45 Cat. 5E female connector

2018.5

- 1** Remove the back cap from the connector. Strip approx. 5cm off the jacket and discard the cable cutter cord.

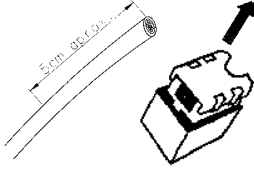

- 2** Bring the cable close to the connector, with the jacket at approx. 6 mm from the connector. Insert the cables into the corresponding slots as indicated by the cable colour-wiring configuration for T568A or T568 B (as shown in Figures 2A and 2B).

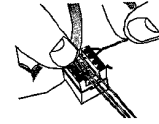

- 2a** Wiring according to T568A:

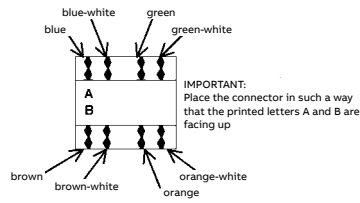

- 2b** Wiring according to T568B:

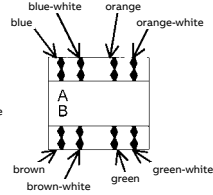

- 3** Push the cables against the end of the slot and cut them flush to the connector. Use an IBDN 110, BIX, KRONE wiring tool, or a similar type 110 tool.

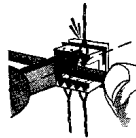

- 4** Mount the connector cap.



## VDI connectors

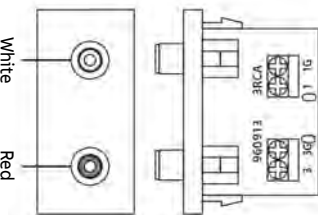

**N2155.2**  
Pin Out:  
1G — W/GND } Left Audio  
1B — White }  
3G — R/GNB } Right Audio  
3R — red }

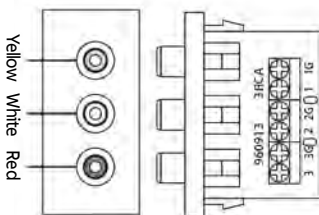

**N2155.3**  
Pin Out:  
1G — Y/GND } Composite Video  
1A — Yellow }  
2G — W/GND } Left Audio  
2B — White }  
3G — R/GND } Right Audio  
3R — Red }

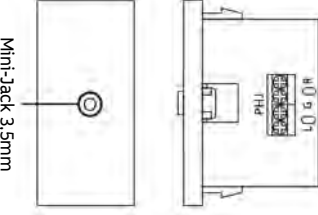

**N2155.4**  
Pin Out:  
R — Red } Left Audio  
G — Ground }  
L — White } Right Audio

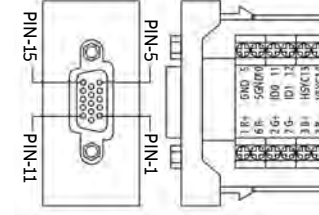

PIN	PIN
1	1 R+
2	2 G+
3	3 B+
4	4 ID2
5	5 GND 5
6	6 R-
7	7 G-
8	8 B-
9	9 GND
10	10 SGND 10
11	11 ID0 11
12	12 ID1 12
13	13 HSYC 13
14	14 VSYC 14
15	15 ID2 15
G	G GND

**N2155.6**

1	TMDS Data2+
2	TMDS Data2 Shield
3	TMDS Data2-
4	TMDS Data1+
5	TMDS Data1 Shield
6	TMDS Data1-
7	TMDS Data0+
8	TMDS Data0 Shield
9	TMDS Data0-
10	TMDS Clock+
11	TMDS Clock Shield
12	TMDS Clock-
13	CEC
14	RESERVED (N.C. on device)
15	SCL
16	SDA
17	DDC/CEC Ground
18	+5V Power
19	Hot Plug Detect
GND	Ground

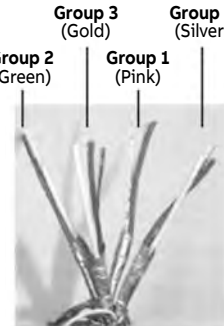

Group 3 (Gold)    Group 4 (Silver)  
Group 2 (Green)    Group 1 (Pink)

On Group included 3 wires

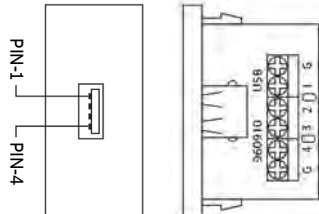

**N2155.8**  
Pin Out:  
1 — Vbus  
2 — D-  
3 — D+  
4 — Ground  
G — Shielded

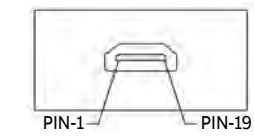
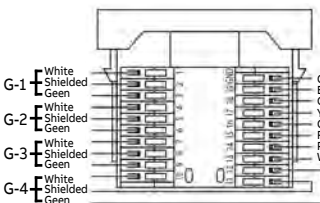
G-1	White Shielded	GND	Ground
	Green	Blue	Hot Plug Detect
G-2	White Shielded	Yellow	+5V Power
	Green	Orange	DDC/CEC Ground
G-3	White Shielded	Red	SDA
	Green	Purple	SCL
G-4	White Shielded	White	Reserved (N.C. on device)
	Green		CEC



**Note:**  
Using a strap for fixing the cable to the board it is recommended to avoid disconnections. For this the plates have two through-holes at its rear end.

## LED rotatory/push dimmer - 2M

N2260.3 & N2260.8

### 1. Technical data

#### Rated voltage / max. power:

- N2260.3: 230 V~ ±10%, 50 Hz / 250 W/VA  
230 V~ ±10%, 60 Hz / 200 W/VA
- N2260.8: 127 V~ ±10%, 60 Hz / 140 W/VA
- Room temperature for operation: 0 to 35 °C.

#### Protection:

- Back-up fuse: Electronic
- Overload protection: Electronic

#### N2260.3 - Rated min./max. power (230 V~):

- LEDi: 2 W/VA / 100W/VA (max. 10 lamps).
- Dimmable energy saving lamps: 2 W/VA / 100W/VA (máx. 10 lamps).
- LV LEDi with transformer: 4 W/VA / 100W/VA (max. 10 lamps).
- Incandescent lamps: 10 W/VA / 250W/VA.
- Halogen lamps: 10 W/VA / 250W/VA.
- LV halogen lamps with transformer: 10 W/VA / 250W/VA.

#### N2260.8 - Rated min./max. power (127 V~):

- LEDi: 2 W/VA / 55W/VA (max. 10 lamps).
- Dimmable energy saving lamps: 2 W/VA / 55W/VA (máx. 10 lamps).
- LV LEDi with transformer: 4 W/VA / 55W/VA (max. 10 lamps).
- Incandescent lamps: 10 W/VA / 140W/VA.
- Halogen lamps: 10 W/VA / 140W/VA.
- LV halogen lamps with transformer: 10 W/VA / 140W/VA.

### 2. Wiring diagram

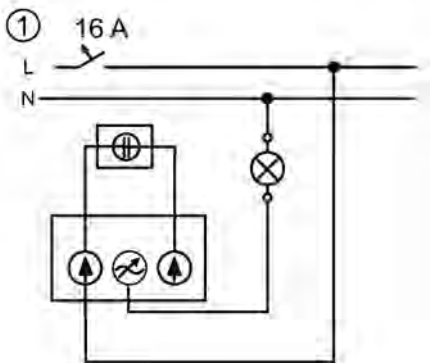

Standard operation

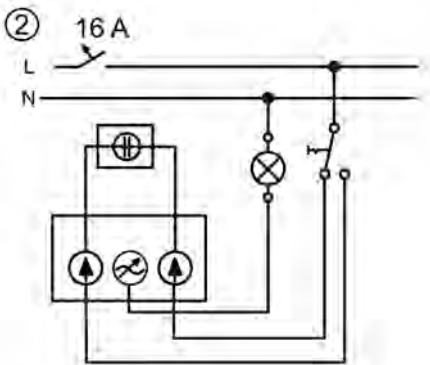

Operation in a two-way circuit

#### Warning:

Disconnect the mains power supply prior to installation and/or disassembly! Permit work on the 230V/127V supply system to be performed only by specialist staff.

### 3. Mounting

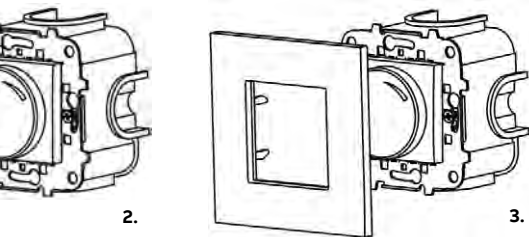
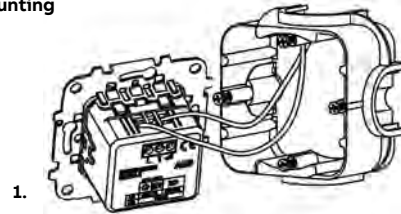

Turn the device in the correct installation position. The marks on the back side of the device, orient the correct top position.

### 4. Set-up

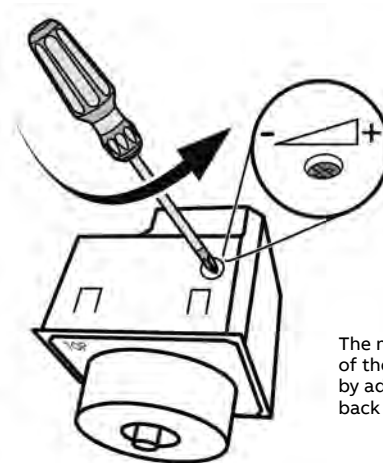

The minimum brightness of the dimmer can be set by adjusting the on the back side of the device.

### 5. Operation

The LED dimmer is a phase-angle dimmer and is used to switch and dim all lamps listed in "Types of load", especially LEDi loads (LED lamps with an integrated ballast). The LED dimmer serves as light controller in connection with rotary dimmer control elements.

#### Notes:

1) Use only L or LC transformers. Pure C transformers are not permitted. If transformers are used, the specifications of the respective manufacturers must be observed. In particular, observe the information regarding the minimum load.

#### Connection load for LEDi

2) Above a connection load of 25 W/VA, suitable measures must be taken to increase the connection load to a maximum of 100 W/VA (230 V supply) or 55 W/VA (127 V supply) when connecting LEDi according to IEC 61000-3-2, for example, through the use of harmonic wave filters.

3) Maximum number of LEDi lamps is 10.

# LED/Universal rotatory dimmer - 1M

## N2160.3 & N2160.8

### 1. Technical data

		max ↑↑↑		N1160.3 N2160.3 AMD60322	N1160.8 N2160.8	Mode
				max W. 230V-50/60Hz	max W. 127V-60Hz	
Leading-Edge	I. LEDi		10	4 - 60 W	4 - 30 W	
	II. LED		10	4 - 60 W	4 - 30 W	
	III. HALOGEN 12V		-	4 - 60 W	4 - 30 W	
Trailing-Edge	IV. LEDi		-	4 - 250 W	4 - 125 W	
	V. LED		-	4 - 250 W	4 - 125 W	
	VI. HALOGEN 12V		-	4 - 250 W	4 - 125 W	
	VII. INCANDESCENT		-	4 - 250 W	4 - 125 W	

#### Types of load supported (see table 1)

Leading-edge dimmable loads:

- I. LED lamps at 230V/127V type L
- II. LED lamps at 12V with electronic transformer
- III. Halogen lamps at 12V with electronic transformer

Trailing-edge dimmable loads (recommended):

- IV. LED lamps at 230V/127V type C
- V. LED lamps at 12V with electronic transformer
- VI. Halogen lamps at 12V with electronic transformer

Traditional loads:

- VII. Incandescent and halogen lamps.

#### Technical data

Nominal input voltage	(see tables 1)
Nominal input frequency	50 / 60Hz
Operating temperature	-5°C... +35°C
Maximum power supported:	(see tables 1 and 2)
Load type selector	Yes
Off position	Yes
Possible extension for ON/OFF	No
Connection wires	2 o 3
Short-circuit & overload protection	Yes
Temperature protection	Yes
IP protection	IP20
Safety standard	IEC 60669-2-1

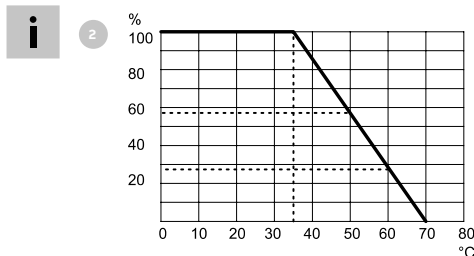

#### Performance

The dimmer's nominal power will decrease according to ambient temperature in line with the graph. If 2 regulators are installed adjacent, reduce max. power to 50%. If 3 adjacent regulators are installed, reduce max. power to 25%.

### 2. Wiring diagram

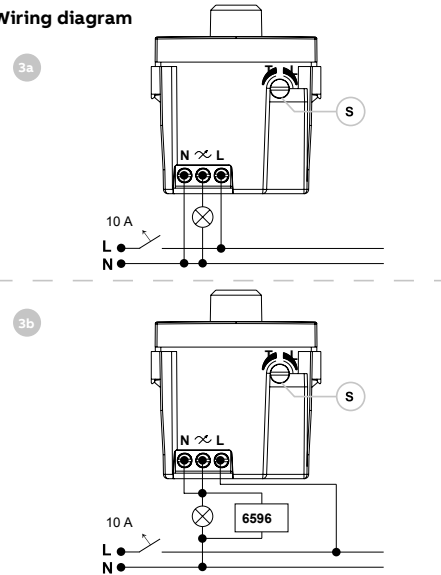

### 3. Connection

#### 3 WIRES (recommended):

Figure '3a' shows an example of a 3-wire connection.

#### 2 WIRES:

Figure '3b' shows an example of a 2-wire connection. This connection is subject to load compatibility, and correct functioning in all cases cannot be guaranteed (see note above). The minimum load installed must exceed 14W and it must be complemented with a 6596 compensation filter in parallel.

### 4. Set-up

1. Check the voltage is disconnected.
2. Configure the dimmer functioning mode using the adjustment dial, according to the type of load (see table 1)
3. Place the arrow at the bottom end (-) of the selector dial 'S'
4. Connect all wires through the rear terminals.
5. Make sure that the wires are correctly installed and free of potential short-circuits.
6. Restore the general power supply.
7. Switch on the lamps by turning the dimmer switch.
8. Adjust the minimum threshold by placing the arrow of the selector dial 'S' at the lowest point at which the lamps emit light without flashing.
9. Insert the mechanism in the recess box.

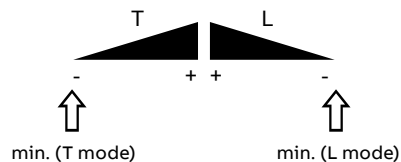

Make sure that the proper functioning mode has been configured (L or T) according to the type of load. Otherwise, the dimmer and the lamp could be damaged.

#### Note

Given the heterogeneity of the lamps and manufacturers in the market, some LED lamps may not be compatible with the dimmer resulting in persistent flashing problems. To avoid these problems, we recommend using the lamps of recognised manufacturers, avoiding the mixture of models and types whenever this is possible.



## Rotary dimmer 1-10 Vdc for fluorescent or LED drivers

N2260.9

### 1. Technical data

- Power supply:  
230V 50-60Hz 700VA  
127V 50-60Hz 350VA
- Load type: Dimmable electronic ballast with 1-10V control input.

### 2. Assembly/Connection

#### 2.1. Connection

Follow the steps below to install the mechanism:

1. Connect the device according to the connection schemes.  
Figure 2 and Figure 3.
2. Assemble the device on the flush mounting box.
3. Then, place the plate.

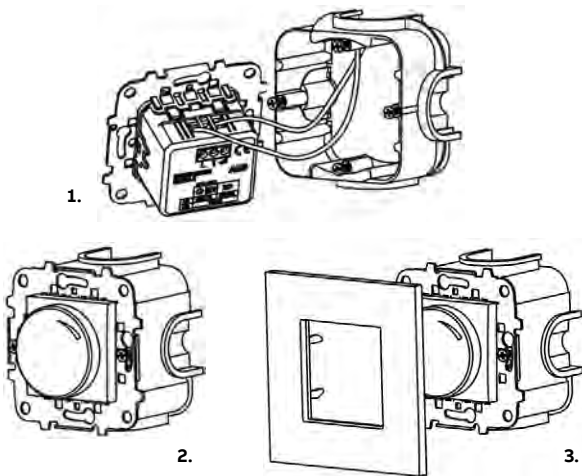

Figure 1: Installation

**Important:** Disconnect the power supply when installing.

#### 2. Connection

The fluorescent lighting dimmer N2260.9 may be connected to dimmable electronic ballasts with a control input of 1-10 V as shown in Figure 2:

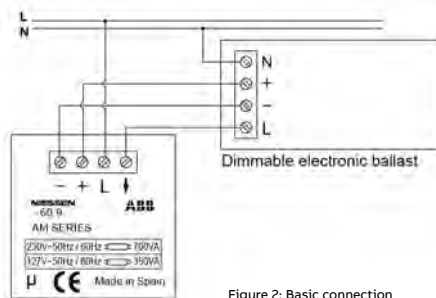

Figure 2: Basic connection

The maximum charge to be connected to the control terminals +/- should not exceed 50 mA.

See technical specifications of the dimmable electronic ballast to be installed.

Electronic ballasts generate a very high instantaneous peak current at connection, therefore it is recommended not to connect more than 6 ballasts to the N2260.9 fluorescence regulator.

In installations where it is required to connect more than 6 electronic ballasts to the same regulator mechanism, it is recommended to use a contactor to protect the mechanism contacts. See Figure 3.

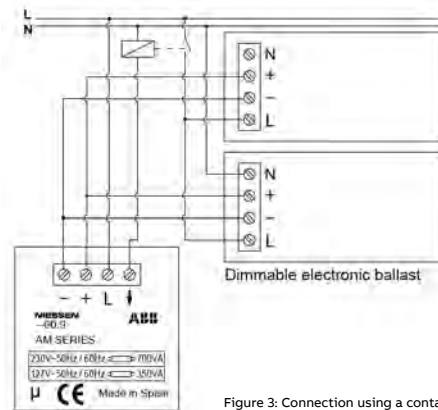

Figure 3: Connection using a contactor

#### 3. Operation button turns in the clockwise direction

If the charge is disconnected, i.e. the rotary button is completely turned counter-clockwise, when turning right the charge will turn on (a "click" will be heard) and the intensity level will increase as we turn the button in the clockwise direction.

If the charge is at a given point of regulation, the charge intensity will increase as we turn the button in that direction.

If we turn the button completely in the clockwise direction, this will stop in a limit, which will coincide with the maximum regulation intensity level.

#### Operation button turns in the counter-clockwise direction

Intensity level will reduce as we turn the button in the counter-clockwise direction.

If we turn the button completely in the counter-clockwise direction, a "click" will be heard and the button will stop in a limit, the charge will be disconnected.

**WARNING:** This product should only be used with the compatible loads defined in the compatibility table above.

Any installation outside the declared power range could cause damage to the product that could result in malfunction or even accidents.

# 1 Module dimmer - N2160.E

## 1. Technical Data

### Voltage:

N2160: 127 V~ ; 60 Hz

N2160.1: 230 V~ ; 50-60 Hz

### Power:

N2160: 50-500 W 

N2160.1: 50-700 W 

### Operating temperature:

0 – 30° C

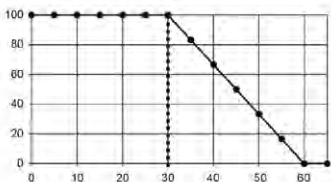

**Table 1:**  
Power reduction (%) as a function of temperature (°C)

## 2. Assembly/Connection

### 2.1. Assembly

#### Important:

If the dimmer is installed next to another electronic device that can produce heat, the maximum power must be reduced in half.

If it is installed between two electronic devices that can produce heat, the maximum power must be reduced to the fourth.

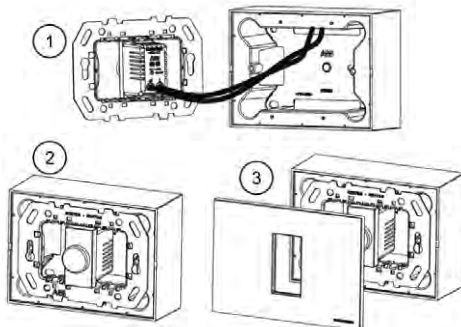

### 2.2. Connection

#### Important:

Disconnect the power supply when installing.

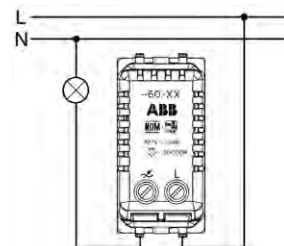

### 3. Operation

Do not exceed the maximum shown in Table 1, since the dimmer has a NON-resettable thermal fuse. If the fuse is triggered, the electronic dimmer is useless for further use. In case of exceeding the maximum load, the fuse could not trig but it may happen that the load will not turn off.

## Electronic switch cookie - 8132.1 & 8132.2

### 1.- Description

Electronic switch pill (127V~60Hz), code 8132.1 and electronic switch pill (230V~50Hz), code 8132.2.

The electronic switch incorporates a remote control switch with a NO (Normally open) output contact, potential-free.

The output contact changes state every time the auxiliary input (A1, A2) of the electronic switch is phase-supplied (L) from one or many push switches connected to A1 and A2 inputs. One push to the switch closes the output contact of the electronic switch and the next push opens the contact.

Unlike a contactor, the coil of the electronic switch does not remain live and, therefore, there is no permanent energy consumption when it is not pressed.

Assembly by embedding in distribution box or false ceiling. If necessary, the screw tabs can be manually removed by bending by the corner until they come off.

### 2.- Technical details:

Rated voltage:

- 8132.1: 127 V~ 60 Hz
- 8132.2: 230V~ 50 Hz

Rated power: 10 A

Suitable for (230 / 127 V~):  
LED lamps (up to): 400 / 200 W.

Incandescent/Halogen lamps  
(230V): 2.000 / 1.000 W.

Low-voltage halogen lamps with  
transformers (12 V): 1.000 / 500 W.

Fluorescent lamps: 600 / 300 W (60 $\mu$ F).  
Switch type: single pole NO

Standard: EN60669-2-2

Standby power consumption: 0 VA

Operation power consumption: 0 mW

Min. time span of push button: 0,05 s

Min. interval of push button:  
0,1 seg (maximum 20 per minute)

Dimensions: 61 (46) x 32 x 19 mm  
(without flaps)

Temperature range: -20°C ~ +45°C

### 3.- Electrical diagram

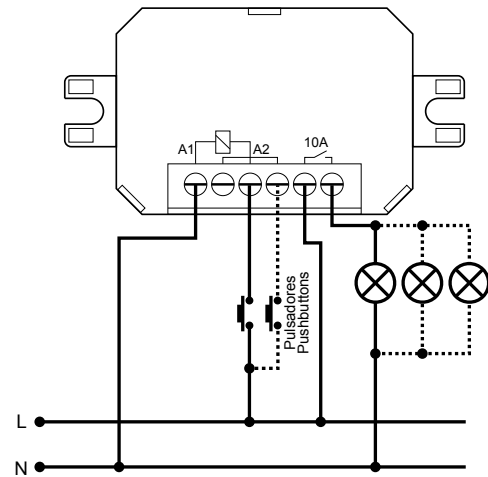

# Movement detector - N2241

## 1. Introduction

This motion detector device senses the movement of people in an area of 5m (maximum) and in a 110° angle. Depending on the level of light detected by the light sensor and the motion detected in the covered area, the device determines if the load connected to it should be activated or not, thus lighting the area in which it is connected whenever someone passes. While it is detecting movement, the device maintains the load activated. When it stops detecting motion it disconnects the loads in the preset time. The device enables remote control through conventional push buttons with the use of only one conductor and thus simplifying electrical installations with the possibility to substitute the traditional switched installations.

## 2. Technical Characteristics:

**Power supply:** 230 V~ ; 50 Hz  
127 V~ ; 60 Hz

### Maximum power:

Incandescent lamps: 1,800 W (230 V~ 50 Hz)  
1,000 W (127 V~ 60 Hz)

Halogen lamps with electronic transformer, or halogen lamps with ferromagnetic transformer:  
750 VA (230 V~ ; 50 Hz)  
400 VA (127 V~ ; 60 Hz)

Fluorescent lamps or motors: 400 VA (230 V~ ; 50 Hz)  
200 VA (127 V~ ; 60 Hz)

### Voltage free relay output: 2 terminals:

- Control capability through auxiliary push buttons (N2X04.X).
- Timer adjustment: Between 10 sec. and 10 minutes.
- Adjustment of light set point level for detection.
- Room temperature for operation: -10° C to 40° C.
- Detection range of the IR motion sensor: Max. 5 metres in a 110° angle.

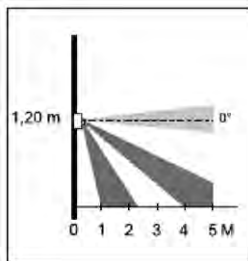

Figure 1: Cross section diagram showing the detection area

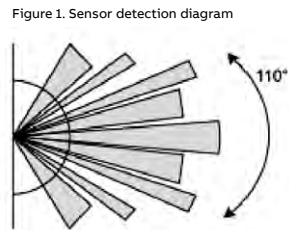

Figure 1: Horizontal view diagram showing the detection area

## Front device description

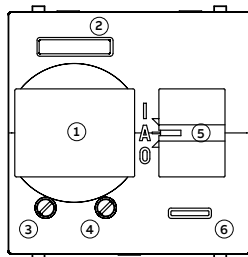

Fig 2.- Front view of the device

1. Detection lens
2. Light sensor
3. Light set point selector
4. Timer selector
5. Operating mode selector (3 positions):  
I – Always on  
A – Automatic (central position)  
0 – Always off
6. Red LED, indicator of automatic operating mode. It does not light when operating in modes I and 0.

## 3. Wiring

### Pre-installation recommendations

Install the device away from heat sources or draughts. The sensitivity of this detection device depends on several factors such as temperature, ambient humidity, as well as speed and direction of people's movement. Before installing the device, it is important to determine where to install it so that it adequately covers the desired detection area.

## Basic wiring

The electrical wiring of these devices is performed according to the wiring diagram shown in Figure 3. The terminal marked "L" shows the phase wire of the installation. The terminal marked "N" shows the neutral wire of the installation. The terminals marked represent the two terminals of the relay output (voltage free).

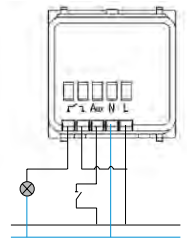

Figure 3: Basic wiring diagram

The terminal marked "aux" (control terminal) is used in case it is desired to control the device (optional) from different points through conventional push buttons (auxiliary pushbuttons). See wiring diagram in Figure 4.

It is possible to use the device as a crepuscular switch if a switch is connected to the control terminal to a pushbutton.

**Note:** Pay special attention to the device input and output conductors, according to the previous description.

Make sure to disconnect the power supply before manipulating the device.

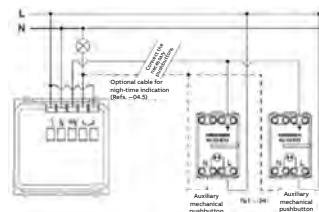

Figure 4: Special wiring diagram

## Wiring of several devices in parallel

The detection area in a zone can be increased by installing more than one motion detector device. To ensure that the detection of movement by any of the devices installed activates the load controlled by all of them, their outputs should be wired in parallel to the load. See wiring diagram in Figure 5.

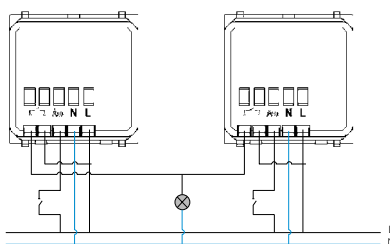

Figure 5: Parallel wiring diagram

## Selection of the light and time threshold

Once the device is wired and installed, based on the type of application, it is important to determine the light value below which the device should activate the load while in Automatic Mode, either by the detection of movement or by pressing the auxiliary pushbutton.

The light set point selector (see Figure 6) enables the selection of the light threshold below which the detector will activate the load.

- If the potentiometer is turned to the left (anti-clockwise), the device will activate the load whenever it detects movement, regardless of the light value, during either day or night.

-If, on the contrary, the potentiometer is turned to the right (clockwise), the device will activate the load when it detects movements under low light conditions, i.e. almost in the dark.

## Movement detector - N2241



Figure 6: Exploded view of the selection potentiometers for the selection of light and time thresholds.

The load disconnection time is another important parameter that needs to be chosen. The set value will be based primarily on the type of application and the area in which the detector is installed. The time can be chosen easily by turning the time selector potentiometer (see Figure 6).

#### 4. Installation

To install the device follow these steps:

1. Connect the device based on the wiring scheme. Figures 3, 4 and 5.
2. Mount the device on the wall box.
3. Then, position the plate.



Figure 7: Installation for N2241

The load disconnection time is another important parameter that needs to be chosen. The set value will be based primarily on the type of application and the area in which the detector is installed. The time can be chosen easily by turning the time selector potentiometer (see Figure 6).

#### 5. Operation

The motion detector device has 3 different operating modes that the user can select at any time using the selector located at the front of the device.

The available operating modes are the following:

- I – Always on
- A – Automatic (central position)
- O – Always off

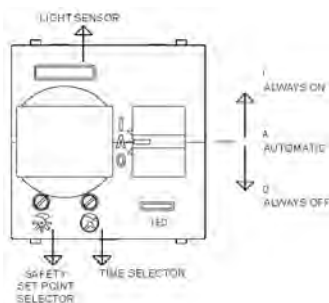

#### Operating Mode "I": Always On

How to select the operating mode "Always On"

- The operating selector is in position I: Always On
- The front red pilot is off

In this operating mode, the load is always activated, regardless of the light

level or the movement detected within the covered area.

While in this mode, the device does not respond to the auxiliary push button that may be connected to the control terminal.

#### Operating Mode: Automatic (A). Motion detector.

How to select the operating mode "Automatic"

- The operating selector is in position A: Automatic.
- The device indicates it is in the Automatic operating mode by lighting the front red pilot.
- Optionally, the auxiliary push buttons wired to the control terminal can be used.

This operating mode enables the independent activation and deactivation of the load, based on the movement detected within the covered area and on whether the light level is above or below the set threshold.

When the device detects movement of people and the light level sensed is below the set point, then it activates the load. With the conditions described above and while the device detects movement, the load will be activated.

Once the device stops detecting movement, it will deactivate the load based on the time set for deactivation; in this way, the device will be on standby until it detects another movement within the covered area.

When one of the auxiliary push buttons that may be connected to the control terminal is pushed, the device will behave as if it had detected movement. It will activate the load whenever the light level in the covered area is below the set point and will deactivate the load if no movement is detected within the time set.

#### Operation as Crepuscular Switch

The device can be operated as a crepuscular switch, i.e. it can activate the load when the light level is below the set threshold, no matter if there are people moving in the area or not. In the same way, the device may deactivate the load when the light level goes above the selected threshold.

How to select the operating mode "Automatic" when the device works as a crepuscular switch.

- The operating selector is in position A: Automatic
- The device indicates it is in the Automatic operating mode by lighting the front red pilot.
- Instead of using auxiliary push buttons, wire a switch to the control terminal and then, wire the terminal to the phase wire. When the switch is closed, the device operates as a crepuscular switch.

This operating mode is a well defined application derived from the device Automatic operating mode. In this mode, the device operates as a crepuscular switch, so that when the front light sensor detects a decrease in the light level below the set threshold, the switch activates the load, regardless whether there is movement of people or not within the covered area.

Once the light in the room collected by the sensor exceeds the set light threshold, it disconnects the load.

**Note 1:** For the correct operation of the device as a crepuscular switch, the device should be kept away from the light source (load) it controls. In this way, the purpose is that the device's light sensor only collects the room light (not artificial) that will determine if the light loads automatically controlled by the device should be turned on or off.

**Note 2:** This operating mode automatically decides whether to connect or disconnect the loads, based solely on the light collected by the device's light sensor. Therefore, the operation of the device does not rely on or respond to the movement of people within the covered area, if the switch connected to the control terminal is closed to the phase wire.

## Time delay switch

N2262.1

### 1. Technical data

- Rated Voltage: 230 V~ ; 50 Hz

- Maximum power:

☀ 40 - 500 W for incandescent lamps.

⚡ 40 - 400 VA for halogens with conventional transformers.

Ⓜ 40 - 100 VA for motors.

Protection against overcurrents:

Through calibrated fuse F-3,15H. It is supplied with a replacement.

Protection against faulty connections:

Through electronic device.

Time delay: from 10 sec. to 10 min. ( $\pm 10\%$ ).

Night vision device: red LED.

Operating temperature: from 0 to 40 °C.

### 2. Wiring diagram:

The electric connection of these articles is carried out in conformity with the presentation of the following Figures. The «L» terminal indicates the connection with the installation phase wire, and the arrow exiting the device indicates the connection to the receptor.

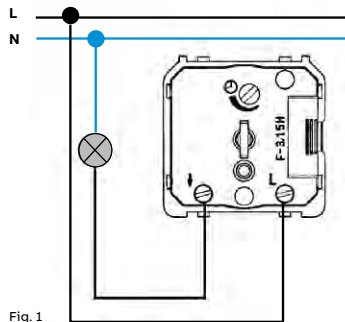

Fig. 1

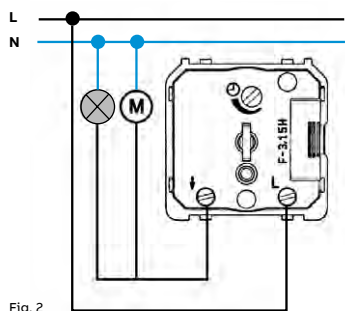

Fig. 2

#### NOTE:

Pay particular attention to the connection of exit/entry device conductors, as shown in the diagrams.

When manipulating the device, make sure it is disconnected from the power grid.

For the applications requiring the timing of an engine of less than 40VA power, for example a small air-extractor engine with 13VA in a bathroom, the connection will be possible if you connect another load to the latter, so as to make sure the addition of both power loads results in a power output which is greater than 40VA, the minimum load required for the correct operation of the device.

If an engine is connected to another load (a halogen or incandescent lamp), the maximum power load of the latter has to equal the maximum power output value of the engine.

### 3. Mounting:

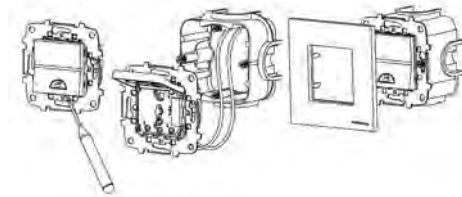

Fig. 3

1. Connect the device according to the instructions cited in the subsection on connection grid systems. Do not manipulate the device when connected to the power grid.
2. Introduce the mechanism in the flush-mounting box holding it with the screws of the box (or with fixation claws, if the box is equipped with them).
3. Set the time delay.
4. Mount the frame.
5. When mounting the other series, insert the frame between the support and the body and screw the support to the body. Mount the key on the support.
6. The time delayed switch is ready to use.

### 4. Operation:

The time delayed switch is an electronic operation mechanism making the automatic disconnection of the controlled element, within an adjustable time interval.

The manual operation is carried out by pressing the key.

Setting the desired time margin for disconnecting the device, is carried out by using an adjusting screw, as indicated on Figure 4. The time range is adjustable from 10 seconds to 10 minutes ( $\pm 10\%$ ).

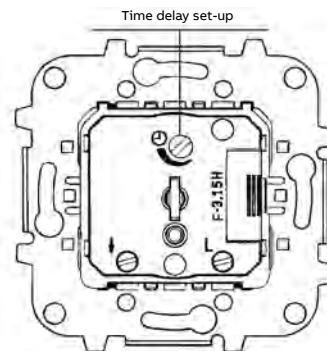

Fig. 4

## Rotatory thermostat with remote sensor

N2240.3

### 1. Technical data

**Voltage:** 230V~ +/-10% 50-60Hz

**Load power:** 2.300W.

**Load type:** floor heating resistor.

**Control temperature:** +5°C to +45°C (Set point).

**OFF state:** at OFF position, the thermostat is off, so that it does not address the temperature measured by the floor temperature probe. The relay output contact is open.

**Temperature accuracy:** 0,5°C.

**Hysteresis:** 0,5°C.

**Floor temperature sensor:** NTC, 10KΩ at 25°C, -40°C to 80°C.  
Double isolated cable, 4m length.

**LED light indication:** red and green

**Ambient temperature:** -20°C to 45°C

### 2. Wiring diagram:

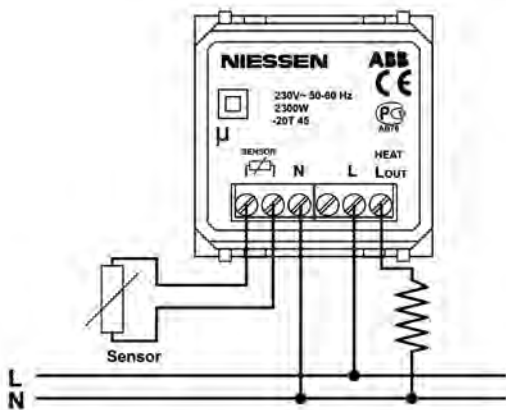

In order to get the better temperature measurement performance possible at the floor thermostat installation, it is recommended:

- Install the thermostat higher than 1m height from the floor.
- Do not install the thermostat near other heat or cold sources.
- Keep the floor temperature sensor away from interference sources or power circuits.
- Check the floor temperature sensor is correctly connected.

**Important: Disconnect the mains voltage power when installing. Work on the 230 V supply system may only be performed by specialist staff!**

**Disconnect main power supply prior to installation and/or disassembly!**

### 3. Mounting

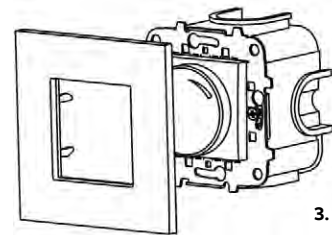
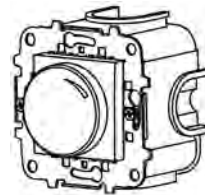
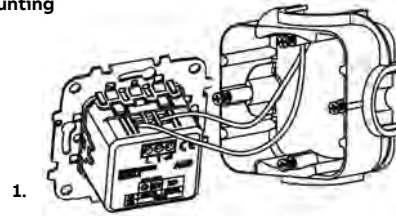

### 4. Operation:

The temperature set point can be adjusted by the rotary knob on the front of the thermostat, from +5°C to +45°C.

LED light in the front, indicates the following:

- Red color: Temperature set point is higher than measured temperature at floor sensor. Relay output contact is closed.
- Green color: Temperature set point is lower than measured temperature at floor sensor. Relay output contact is open.
- LED off: Thermostat is OFF state (disconnected).
- Blinking red color: (a) The floor temperature sensor would not be connected or (b) the temperature read by the floor temperature sensor is below -40°C. Relay output contact is closed.

## Digital thermostat

8140.5 + N2240.5

### 1. Technical data

**Voltage:** 230 V~ ; 50 - 60 Hz

**Power consumption:** < 1W

**Control temperature:** +0°C to +50°C

**Temperature accuracy:** ±2°C (±1°C with calibration)

**Resolution:** 0,1°C

**Control output:** potential-free relay contacts (NA).

**Maximum load:** 3A cos φ = 0,5.

**Hysteresis:** 0,5°C

**Pulse-width modulation:** ±4°C difference with the set-point temperature, variable from 100% to 0% modulation.

### 2. Wiring diagram:

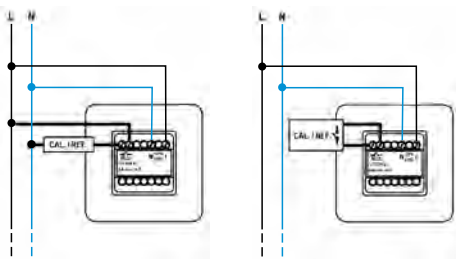

For heating or cooling installations  
WITHOUT potential free input

For heating or cooling installations  
WITH potential free input

**Important: Disconnect the mains voltage power when installing. Work on the 230 V supply system may only be performed by specialist staff! Disconnect main power supply prior to installation and/or disassembly!**

### 3. Mounting



1. Mounting plate
2. Insert - 8140.5
3. Cover plate - N2240.5
4. Frame

### 4. Operation:

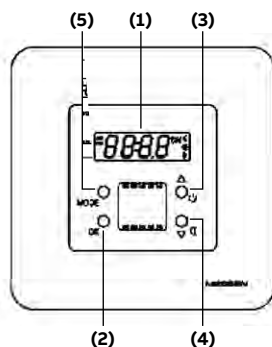

This command allows you to control heating and cooling devices (not simultaneously) from its internal electronic thermostat. Also, thanks to the night mode, allows to maintain a temperature differential (from 0°C to 5°C, also programmable) to save energy with just one keystroke.

### Night operating mode C :

It is based on setting a temperature difference (in °C) between day and night, in order to save energy.

### Winter mode ❄️ :

To be selected when the equipment under control is a heating equipment.

### Summer mode ☀️ :

To be selected when the equipment under control is an air-conditioning equipment.

### Temperature control by hysteresis:

Thermostat's default type of control. The use of hysteresis control is particularly suitable for gas boilers.

### Pulse-width temperature control:

The use of pulse-width control is particularly recommended for electric heaters, heat pumps or electrothermal actuators.

### ATTENTION:

To select between hysteresis and pulse-width, it is necessary that the thermostat is off mode, i.e. the "ON" is not displayed on the screen.

#### (1) TEMPERATURE DISPLAY

Displays the set-point temperature.

#### (2) PUSH BUTTON FOR CONFIRMATION OF SELECTED OPTIONS

Confirms the selected values.

#### (3) ON/OFF AND UP PUSH BUTTON

Turns the control on and off. The display will show "ON" if it is turned on and will turn off when it is off. It serves to increase the temperature displayed on screen.

#### (4) NIGHT AND DOWN KEY PUSH BUTTON

Selects between day and night modes. The display will show C in night mode and in day mode it will disappear. It serves to decrease the temperature displayed on screen.

#### (5) FUNCTIONS/CONFIGURATION SELECTOR

By pressing "we will adjust the set-point temperature" and, if we press successively, we will choose "winter/summer", "night temperature", "thermometer calibration" and "output relay action mode".

- 1 press on "MODE" to adjust the set-point temperature.

While the set-point temperature and the symbol "°C" flash on the display, set the desired value with "▲ and ▼" and press "OK".

- 2 presses on "MODE" to choose between winter and summer.

While the symbols ❄️ / ☀️ flash on the display, set the desired value with "▲ and ▼" and press "OK".

- 3 presses on "MODE" to choose the night temperature differential.

While the night temperature differential and the symbol C flash on the display, set the desired value with "▲ and ▼" and press "OK".

- 4 presses on "MODE" to calibrate the thermometer.

The temperature indicator flashes and with "▲ y ▼" we select the appropriate ambient temperature. It will be set by pressing "OK".

- 5 presses on "MODE" to choose the "output relay action mode". The "STD" or "INC" will be illuminated on the display when pressing "▲ or ▼". We select the right one and we press "OK".

"STD" indicates the operating mode by hysteresis.

"INC" indicates the operating mode by pulse-width modulation.

In all the cases the setting is validated pressing "OK". Failure to do so, the control returns to the previous settings in 5 seconds without saving the new ones.

With the control turned off, it behaves as a thermometer, showing the current temperature.

### ATTENTION:

In the first implementation it is advised to wait **8 hours** before calibration. After an off voltage, the control requires **30 minutes** before showing an accurate temperature.



## Rotatory fan control

N2254.1

### 1. Technical data

**Voltage:** 127 V~ ; 60 Hz

**Load power:** 190 W

**Load type:** ceiling fan.

**Operating temperature:** +0°C to +40°C

### 2. Wiring diagram:

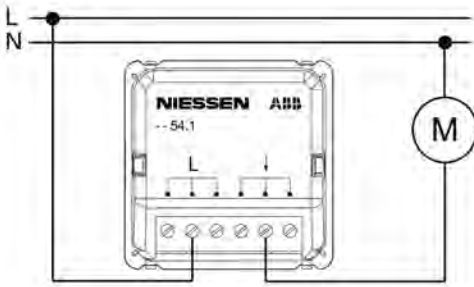

### 3. Mounting:

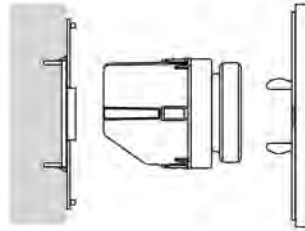

### 4. Operation:

Speed / Button position: 0 Disconnected.

I Maximum speed.

II Medium speed.

III Minimum speed.

**Important:** Disconnect the mains voltage power when installing.  
Work on the power supply system may only be performed by specialist staff!  
Disconnect main power supply prior to installation and/or disassembly!

## Electronic doorbell

N2224 & N2224.1

### 1. Technical data

**Voltage:**

- N2224: 230 V~ ; 50-60 Hz

- N2224.1: 127V~ 60Hz

4 melodies available.

**Acoustic power at 1 meter with cover plate:** 72 dB.

### 2. Wiring diagram:

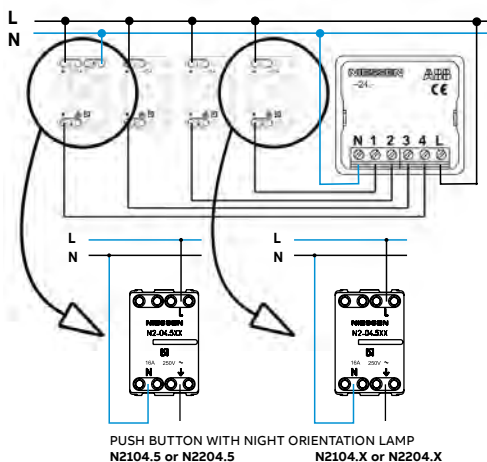

Connection with more than one push-button per melody.

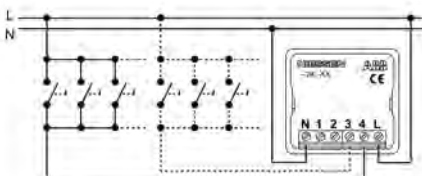

### 3. Mounting

To install the device follow these steps:

1. Connect the device based on the corresponding wiring scheme.

2. Mount the device on the wall box.

3. Then, position the plate.

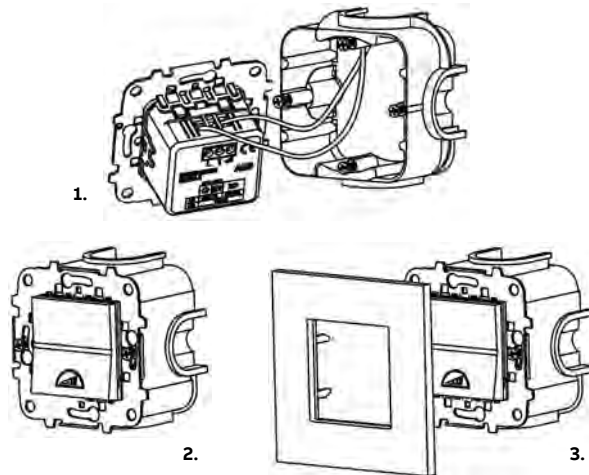

### 4. Operation:

The bell can be connected to 4 push buttons maximum, with a different melody for each one of them.

**Important:** Disconnect the mains voltage power when installing.  
Work on the power supply system may only be performed by specialist staff!  
Disconnect main power supply prior to installation and/or disassembly!

## Buzzer

N2119 & N2219

**1. Technical data**

**Rated voltage:** 127-230 Vac / 50-60 Hz.

**Rated power:** 8 VA.

Adjustable tone.

**Acoustic power at 1 meter with cover plate:** 75 dB.

**2. Wiring diagram:**

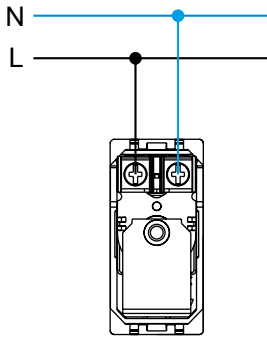

## LED signaling light

N2180 BL/RJ/VD, N2180.1 BL, N2280 BL & N2280.2 RJ/VD

**1. Technical data**

**Rated voltage:** 127-230 Vac / 50-60 Hz.

**Lamp:**

- N2180 BL/RJ/VD / N2180.1 BL / N2280 BL: white LED.
- N2280.2 RJ/VD: red and green LED.

**Luminous flux:**

- N2180 BL/RJ/VD / N2280 BL / N2280.2 RJ/VD: > 2 lumen at 1 meter.
- N2180.1: < 0,5 lumen at 0,3 meter.

**Diffuser:**

- N2180 BL / N2180.1 BL / N2280 BL / N2280.2 RJ/VD: white.
- N2180 RJ: red.
- N2180 VD: green.

**2. Wiring diagram:**

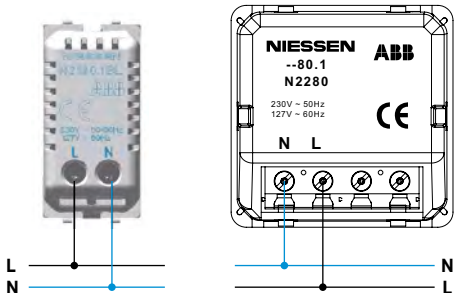

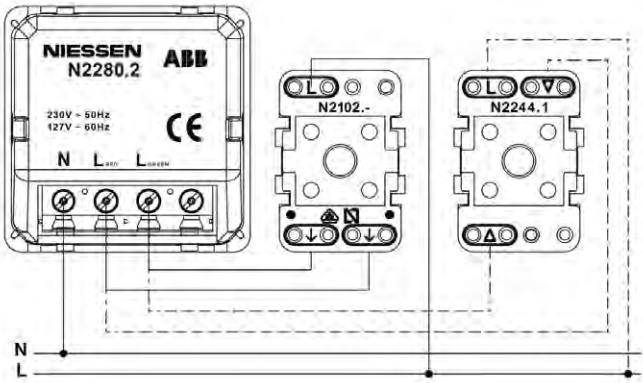

**Important: Disconnect the mains voltage power when installing. Work on the power supply system may only be performed by specialist staff! Disconnect main power supply prior to installation and/or disassembly!**

**3. Mounting:**

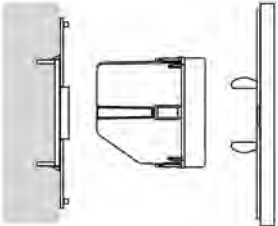

## LED beacon light

N2281

### 1. Technical data

**Rated voltage:** 230V~, 50-60Hz (optional 127 Vac version available)

**Alert signals:** it can be selected by the selector:

- (a) - blue color light or
- (b) - high brightness white light

**Autonomy:** 2 hours; 1h at maximum illumination and 1h at lower illumination.

**Remote control:** supports any standard remote control over voltages.

**Standard:** UNE-EN60598-2-22 Interference suppression according to norms UNE-21806 y EN-55014.

**Brightness:** more than 2 lumens (lm) at 1 meter distance. Battery Nickes-Metal Hydride (Ni-MH), with less environmental impact.

**Note:** Ni-MH batteries have an estimated life of 4 years. Beacon Pilots correct operation should be verified periodically. In the absence of voltage and previously to have been connected to voltage for more than 24 hours, the mechanism should provide a minimum of one hour beacon lighting, if not, replace the mechanism.

### 2. Wiring diagram:

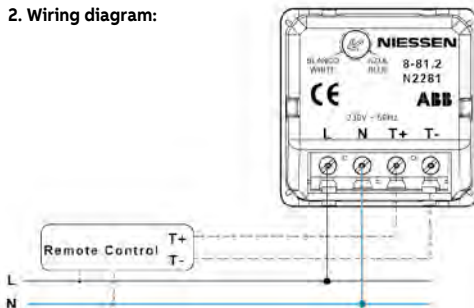

### 3. Mounting:

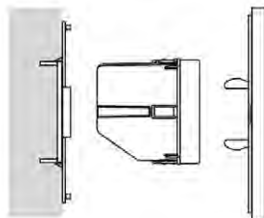

### 4. Operation:

The stairs beacon pilot is an autonomous signaling device, equipped with an electric energy storage battery, which ensures the correct building pathways signaling lighting in the event of a power outage or when it drops below 70% of its nominal value (230V~).

Once connected to mains voltage the device can remain in the following operation situations:

- (1) Alert (signaling)
- (2) Operation (beacon)
- (3) Standby (remote control)

#### Alert (signaling)

The device remains on alert (signaling), provided that the value of the power supply exceeds 70% of the power supply nominal voltage (230V~ 50-60Hz).

#### Emergency operation

It comes into an emergency operating condition when the power supply voltage is less than 70% of rated voltage (230V~ +/-10%). The device is illuminated with high brightness white color.

Note: The time necessary to recharge the device batteries is 24 hours.

#### Standby (remote control)

Situation in which the device remains off, even when the power supply voltage is interrupted. This action is achieved by using a remote control connected to the equipment, as shown in figure "Device connection".

This way you can select certain number of appliances, from the total installed drivers, to remain off in a power failure, thereby reserving the batteries charge in case of a possible need for further use if the power outage is prolonged.

This is achieved by acting on the remote control that generates a continuous control signal or low voltage pulses, which acts on the pilot/s by placing it/them at standby or running again (beacon), as desired.

When achieving this type of installation, make sure of the correct connection of the different drivers.

#### Select the color of the device signaling light in alert situation (signaling).

No need to disconnect the supply voltage of the device to select the alert light through the potentiometer. Although the remote control inputs were connected, these should not be active at the time of selecting the alert light through the potentiometer.

**Important: Disconnect the mains voltage power when installing.**

**Work on the power supply system may only be performed by specialist staff! Disconnect main power supply prior to installation and/or disassembly!**

## Make Up Room / Do Not Disturb system

N2180.4, N2180.5 & N2244.5

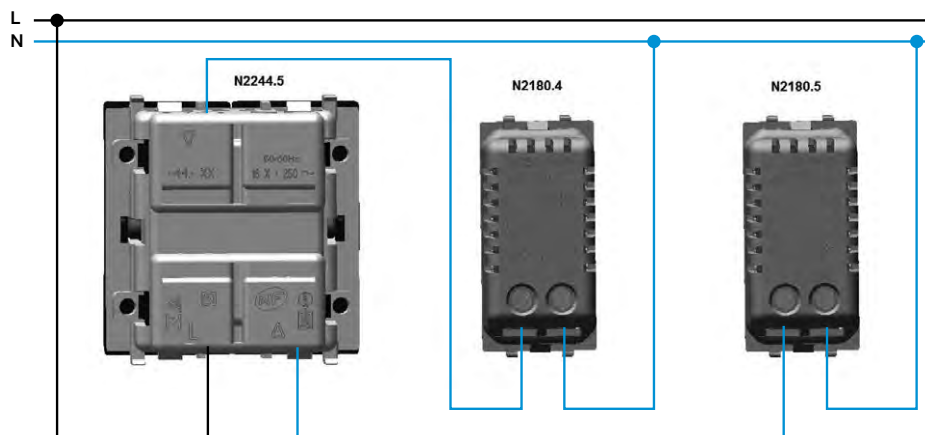

# Make Up Room / Do not Disturb system

N2280.4 & N2244.4

### 1.- Introduction

#### Push switch with bell symbol, "DND" & "Please clean room" indicator

This product is always used for hotel guest room, office, meeting room and so on. It is installed outside the room, allowing the activation of the door bell inside the room, while in the front side of the push-button is shown the preference (Make Up Room / Do not Disturb) selected in the N2244.4 switch placed inside the room.

#### Danger

Dangerous currents flow through the body when coming into direct or indirect contact with live components. This can result in electric shock, burns or even death. Work improperly carried out on current-carrying parts can cause fires.

- Disconnect the mains power supply prior to installation and/or disassembly!
- Permit work on the 230 V supply system to be performed only by specialist staff.

### 3.- Wiring diagram

The terminals marked L are connected to the L of the pushbutton mechanism

### 4.- Mounting

To install the device follow these steps:

1. Connect the device following the wiring diagram.
2. Mount the device on the wall box.
3. Then, position the frame.

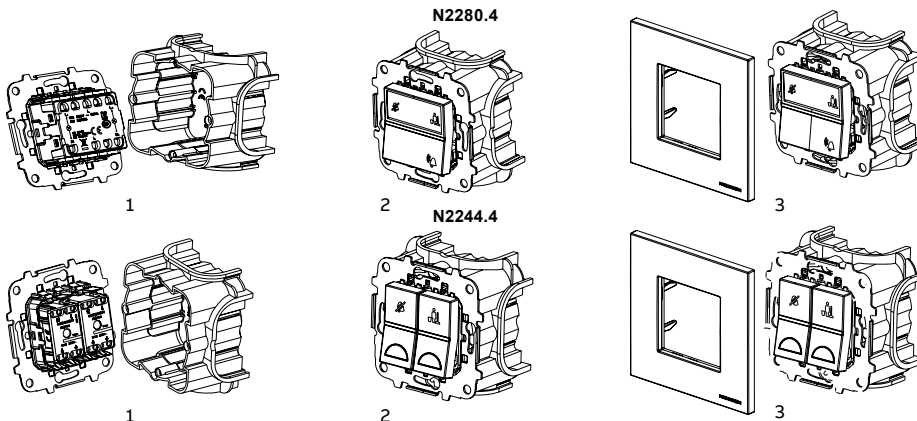
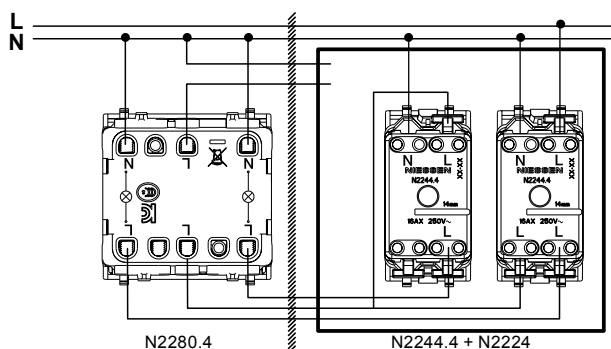

### 2.- Technical data

Rated current:  
10A / 250V~  
N2244.4: not interlock  
Compliant with:  
IEC 60669-1 &  
BS-EN60669-1.  
Operating temperature:  
≥+5°C ≤+35°C  
Storage temperature:  
≥-5°C ≤+45°C  
Relative humidity:  
≥0% ≤90% (noncondensing)

### 5.- Operation

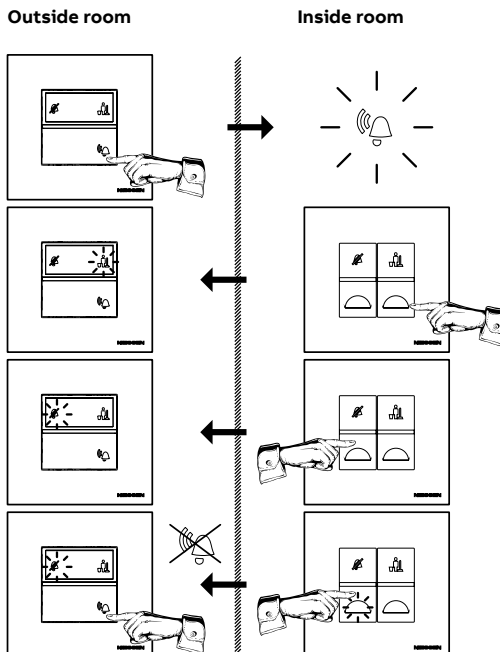

## Zenit elastic claws

### Mounting the claws on the metal mounting plate

The elastic claws are inserted into the metal support of the mechanisms. For this, there is a guide where at the end of the path the claws are clipped and are perfectly secured, making a block with the mounting plate.



Once the claws are assembled, place the screwdriver in the mounting plate to level it and mount it correctly in the box.



The assembly is pressed into the housing.

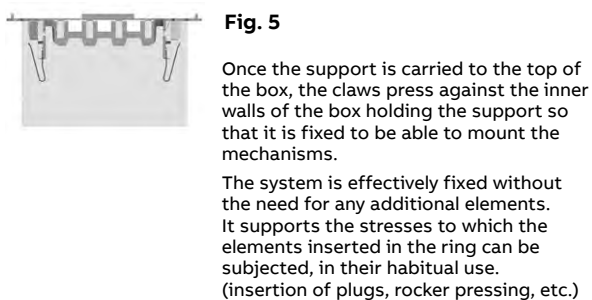
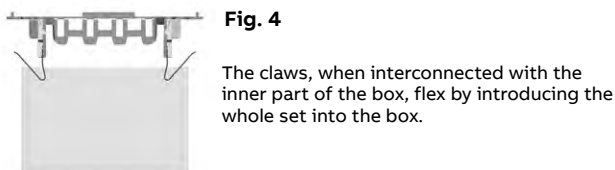

Insertion of a 1-module mechanism in a mountin plate with elastic claws.

- 1- Insert the additional parts (elastic claw insert ref. N2071.8).
- 2- Insert the 1-module mechanism into the metal bracket.

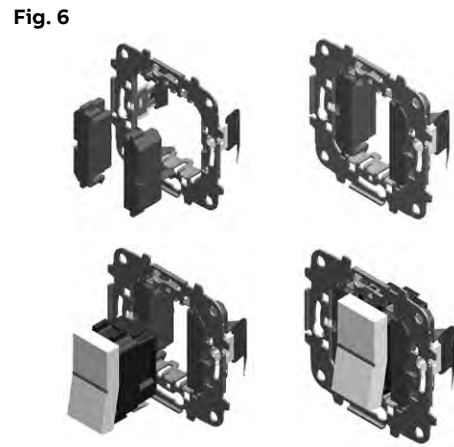

### Removing the mounting plate and claws from the box

In order to be able to disassemble the entire set, simply insert a tool (screwdriver) and press on each of the claws until they are released from the mechanism support, they fall into the inside of the box and it is now possible to remove all the system. To reassemble it you have to restart the whole process explained before.

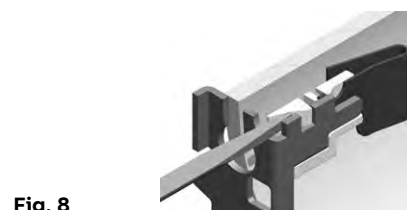

# Zenit sound system

A soundtrack in each space

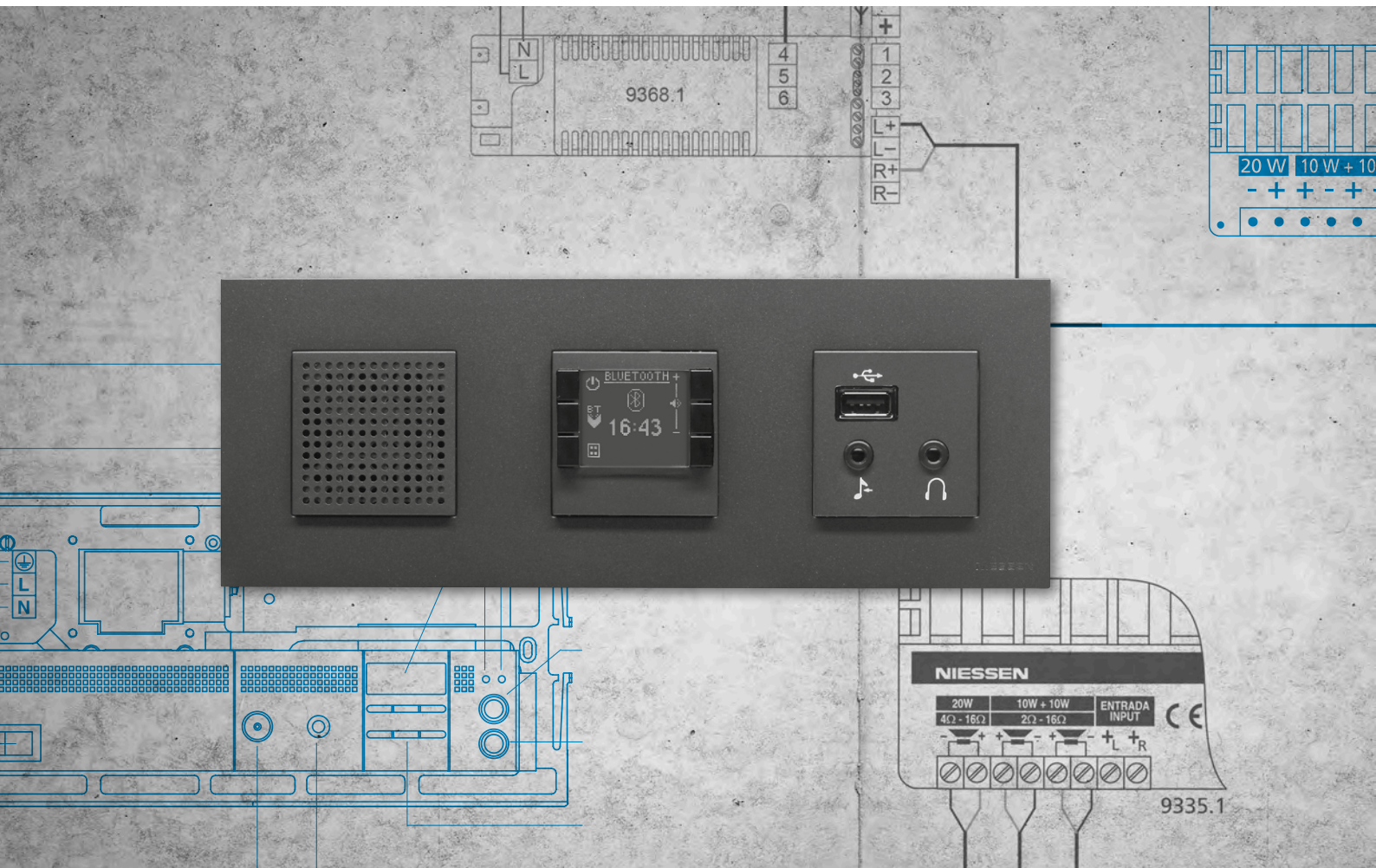

## FM stereo receiver with alarm module

9368

**1. Technical data**

**Rated voltage:**  
 - 9368: 230 V~; ±15%; 50-60 Hz  
 - 9368.7: 127 V~; ±15%; 50-60 Hz

**Max. consumption:** 100 mA

**Stand-by consumption ref. 9368 and 9368.7 (\*):** 0,2 W.

**Stand-by consumption ref. (9368 or 9368.7) + 9368.3 (\*):** 0,5 W.  
 (\*) With the display illumination at minimum.

**Maximum output power:** 2+2 W; <1% distorsion (16 W)

**Speaker impedance:** 16 W (2+2 W audio)

**3. Mounting:**

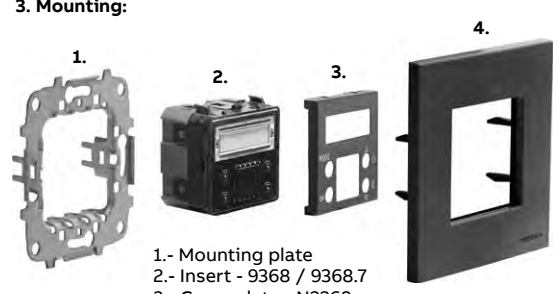

1.- Mounting plate  
 2.- Insert - 9368 / 9368.7  
 3.- Cover plate - N2268  
 4.- Frame

(\*) FM RECEPTION

The FM indoor antenna that incorporates the module 9368 or 9368.7, uses the electrical network to improve reception. If the reception is not quite right, you can connect an external FM antenna (thin wire or coaxial wire) in the connectors enabled for it.

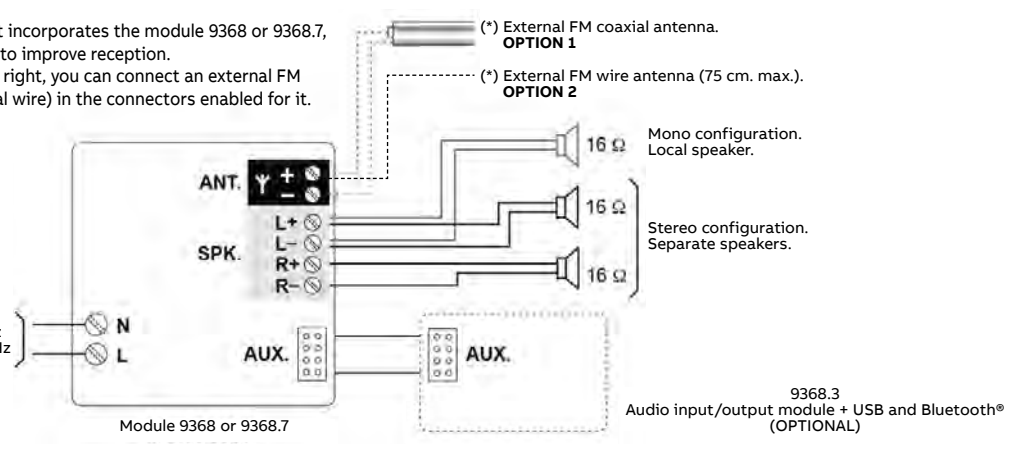

(\*) External FM coaxial antenna.  
**OPTION 1**

(\*) External FM wire antenna (75 cm. max.).  
**OPTION 2**

16 Ω Mono configuration. Local speaker.

16 Ω 16 Ω Stereo configuration. Separate speakers.

9368.3 Audio input/output module + USB and Bluetooth® (OPTIONAL)

9368: 230 V~; ±15%; 50-60 Hz  
 9368.7: 127 V~; ±15%; 50-60 Hz

Module 9368 or 9368.7

## Auxiliary module

9368.3

**1. Technical data**

**Power supply through AUX.:** 9 V

**Maximum consumption:** 175 ~ 200 mA

**Consumption stand-by:** 0.4 W

**Headphones impedance:** 16 ~ 600 Ω (25 + 25 mW audio phones)

**Bluetooth®:** Bluetooth® v2.1 2.4GHz IEEE 802.15.1  
 Maximum reach from the module 9368.3 to user's Bluetooth® device: 10 m.

**3. Mounting:**

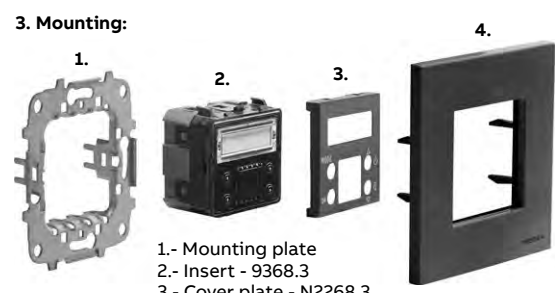

1.- Mounting plate  
 2.- Insert - 9368.3  
 3.- Cover plate - N2268.3  
 4.- Frame

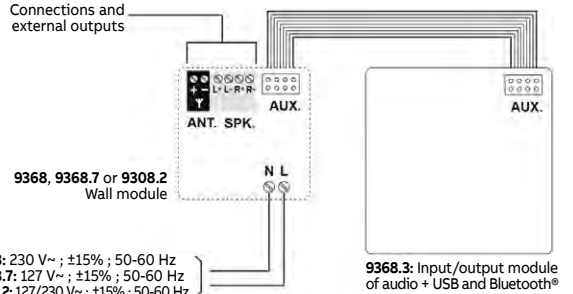

Connections and external outputs

9368, 9368.7 or 9308.2 Wall module

9368.3: Input/output module of audio + USB and Bluetooth®

9368: 230 V~ ; ±15% ; 50-60 Hz  
 9368.7: 127 V~ ; ±15% ; 50-60 Hz  
 9368.2: 127/230 V~ ; ±15% ; 50-60 Hz

**REAR VIEW**

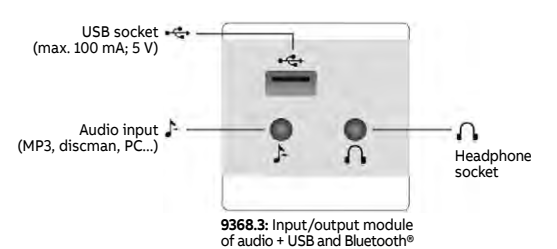

USB socket (max. 100 mA; 5 V)

Audio input (MP3, discman, PC...)

Headphone socket

9368.3: Input/output module of audio + USB and Bluetooth®

**FRONT VIEW**

# Radio & Bluetooth multiroom module + Remote control module

9368.1 & 9368.2

### 1. Technical Data

**Power supply:**

230 V~ / 127 V~; ±15%; 50-60 Hz

**Bluetooth®:**

Bluetooth® v2.1 2.4GHz IEEE 802.15.1  
 Maximum reach from the ceiling module 9368.1 to user's Bluetooth® device: 10 m.

**Maximum power consumption:**

200 mA

**Consumption stand-by:**

0.3 W

**Communication data:**

ZigBee 2.4GHz IEEE 802.15.4

**Antenna impedance:**

75 Ω

**Maximum power headphone output**

6+6 W; <1% distortion (4 Ω)

**Minimum impedance of headphones:**

4 Ω (6+6 W audio)

### 2. Wiring diagram:

BUS MULTIROOM is only necessary if there is more than one room in the house and/or you want to connect the rooms in the house.

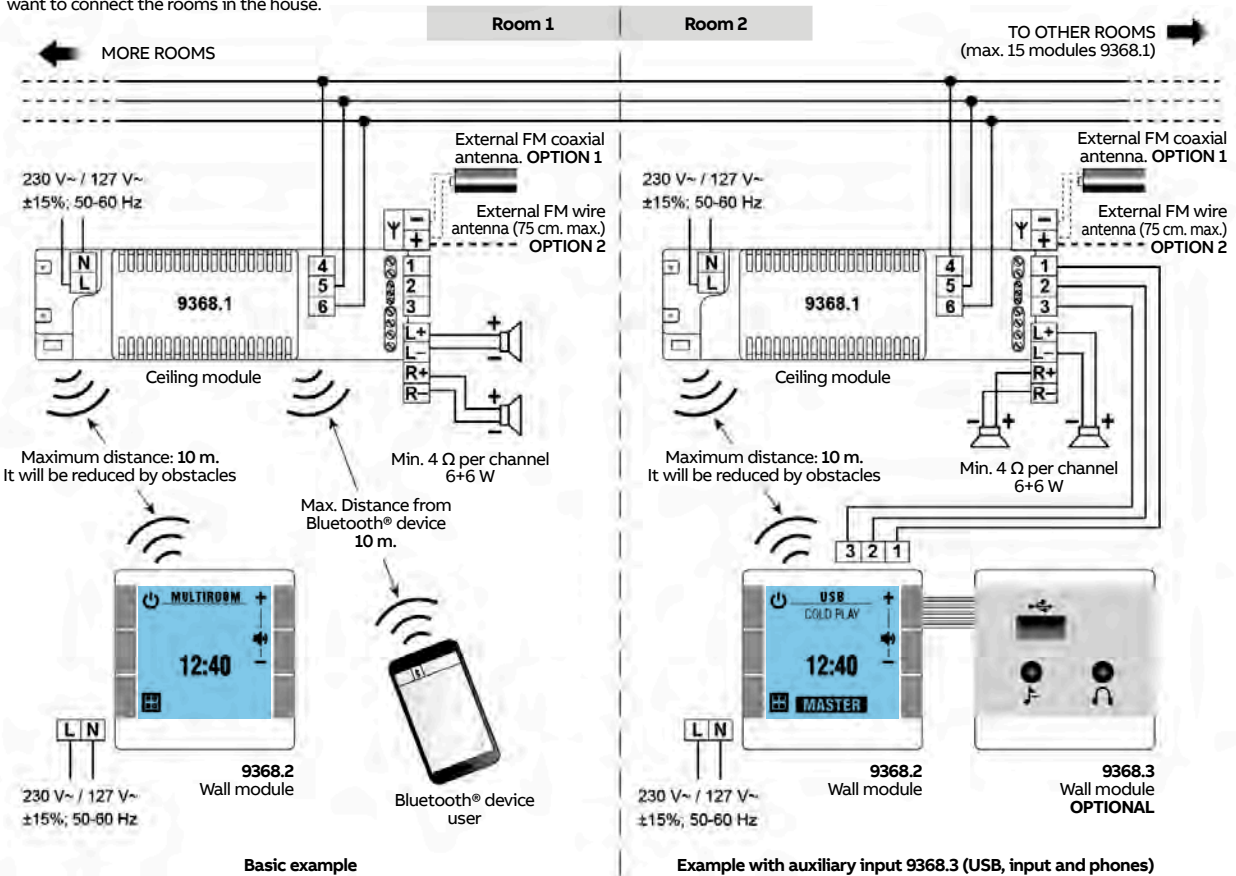

**NOTE:** Because these devices are radio frequency and to avoid interference, you should not install modules of the same reference or any other RF equipment that could interfere less than 1 m. away. It should be noted that any obstacle between the devices, can significantly reduce the distance range between them.

### 3. Mounting:

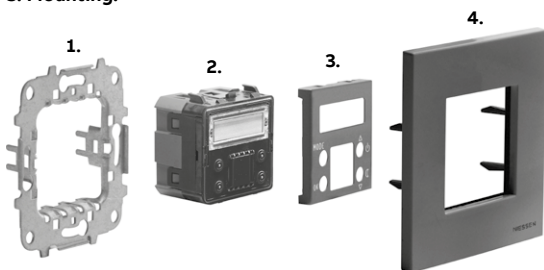

1. Mounting plate
2. Insert - 9368 / 9368.7
3. Cover plate - N2268
4. Frame



## Sound amplifier - Connection to multiroom module

9335.1 - 9368.1

Wiring diagram of 9368.1 module to 9335.1 sound amplifier

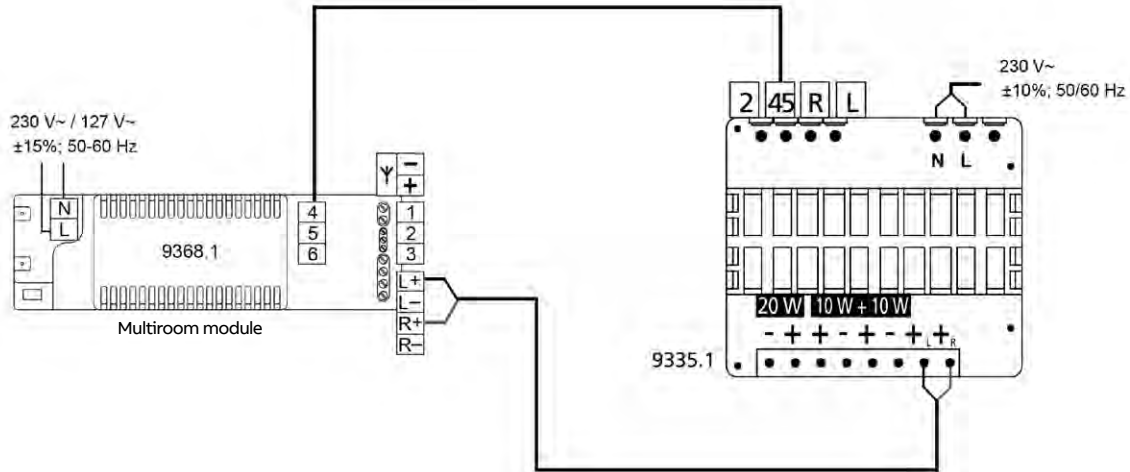

Wiring diagram for 9329.1 loudspeakers to 9335.1 sound amplifier

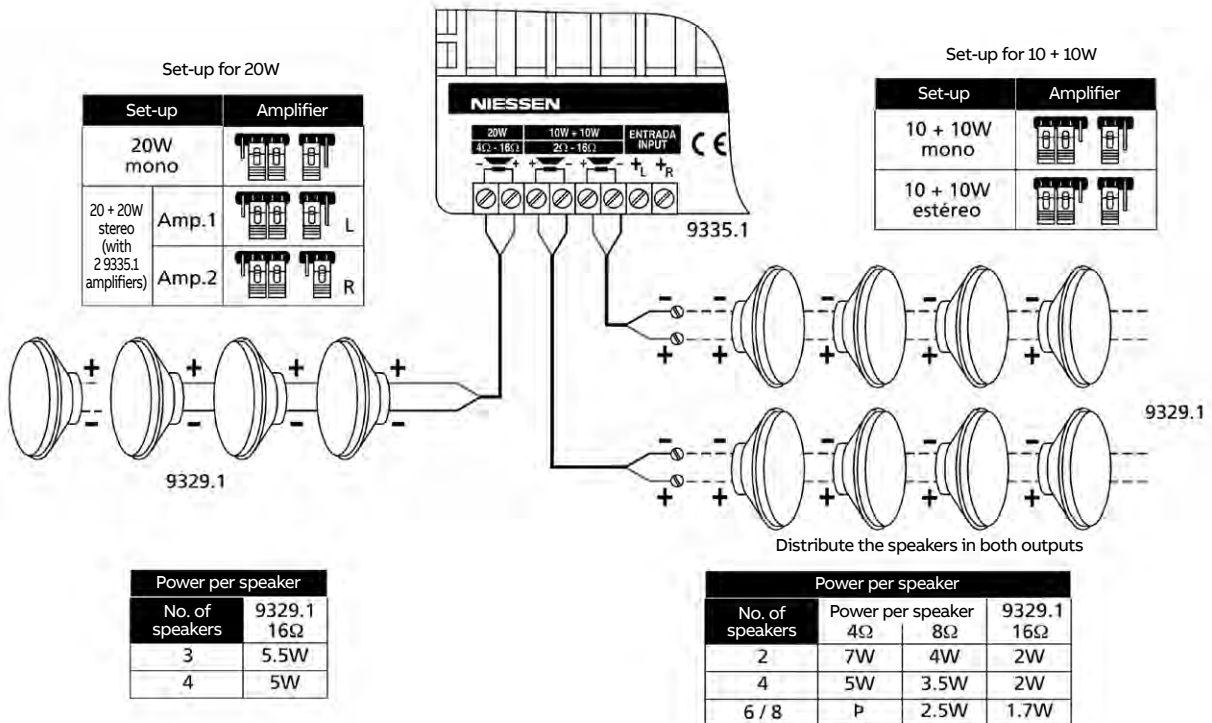

# Bluetooth sound module with amplifier

9368.4

## 1. Technical Data

### Power supply:

230 V~ / 127 V~; ±15%; 50-60 Hz

### Bluetooth®:

Bluetooth® v2.1 2.4GHz IEEE 802.15.1

Maximum reach from the ceiling module 9368.1 to user's Bluetooth® device: 10 m.

### 3 audio inputs:

Bluetooth, AUX (front), TV (rear)

### Maximum power consumption: 7W

Consumption stand-by: 0.2 W

Min input signal level AUX / TV: 500 mV RMS

Input impedance: 10 kOhm

### Amplifier power:

2 + 2 W <1% distortion (16 Ω)

### Speaker impedance:

8 - 16 Ohm

## 2. Connection

[A] Basic: input from jack connector (front) or via Bluetooth®.

Output: amplified signal via R-L terminals (rear).

[B] Complete: input from jack connector (front), via Bluetooth® or rear terminals (LIN-RIN) to connect TV audio.

Output: amplified signal via R-L terminals (rear) to feed speakers

(min. impedance: 8 - 16 Ohm) or external amplifier (ref. 9335.X) for higher power output.

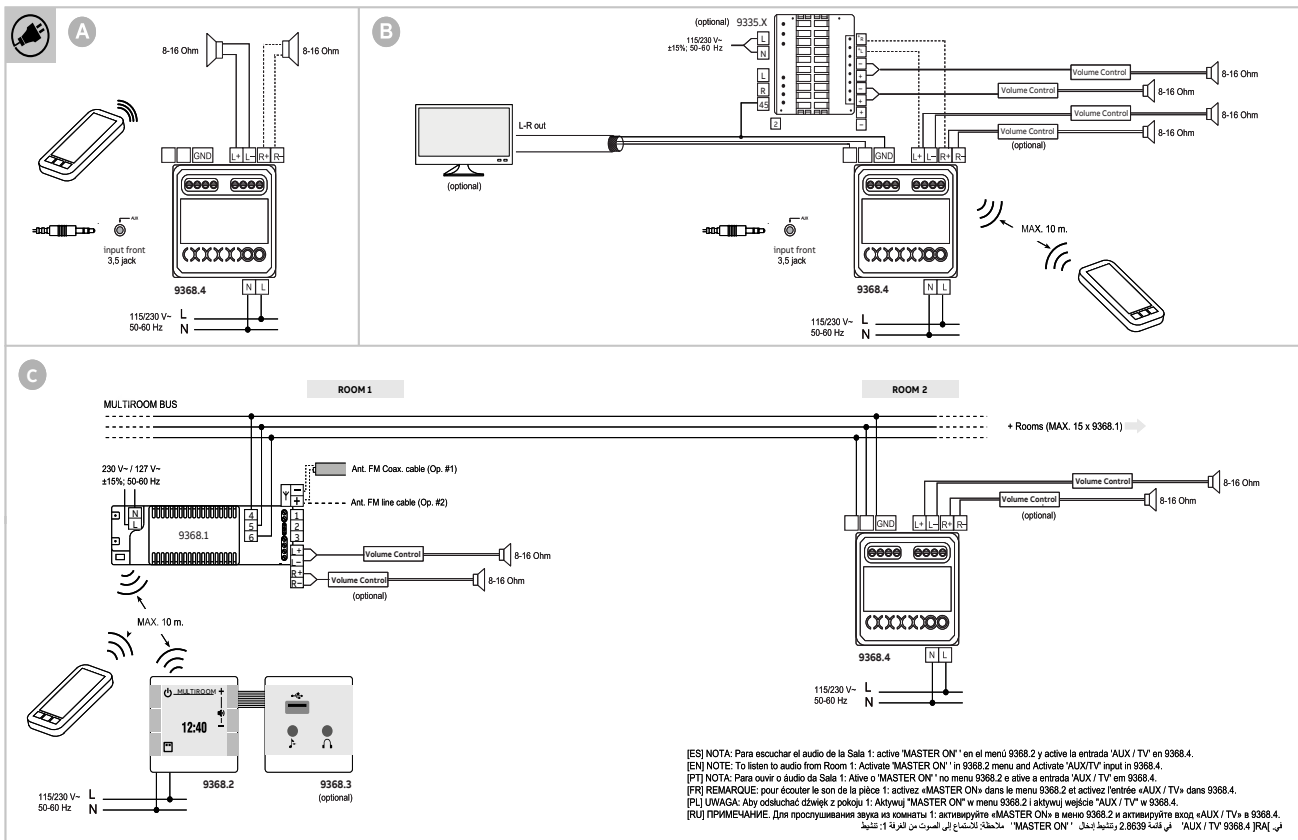

## Bluetooth sound module with amplifier

9368.4

### 3. Set-up

Make sure power supply is disconnected during setup. Connect all wires to rear terminals according to diagrams. Secure mechanism into flush-mounted box using the screws. Connect main power supply.

#### Note:

Avoid installing the module into encapsulated metal boxes to prevent Bluetooth® connectivity issues.

### 4. Control Elements

- [1] ON / OFF
- [2] Bluetooth® mode selection
- [3] Add a new Bluetooth® device
- [4] Volume +/-
- [5] Analog audio mode: rear terminals (TV) or front jack (AUX)

### 5. Status LED

#### Bluetooth®

Blue (still)	Connected to Bluetooth® device
Blue (flashing quickly)	<ul style="list-style-type: none"> <li>• No stored devices</li> <li>• Ready to sync to new devices</li> </ul>
Blue (flashing slowly)	Trying to sync with stored device

#### AUX / TV

Yellow	Connected to jack input (front)
Green	Connected to TV input (rear)

### 6. Bluetooth® mode

#### Note:

Activate the Bluetooth® connection in your mobile device to enable BT mode.

#### I. First time sync (new installation/reset)

1. Press [1] to switch ON the BT module
    - The quickly flashing blue LED will indicate that the BT module is ready to sync with new device. If blue LED is not flashing, press [2] to activate BT mode.
  2. Connect your mobile device to the BT module
    - Browse your mobile device to the Bluetooth settings.
    - Depending on the device, a list of BT devices will be displayed automatically. Alternatively select „search for BT devices“ function.
    - Select „ABB-BTR-XXXX“ to sync devices.
- This sync process must be initiated from the mobile device / computer after the blue LED is flashing quickly.
3. Once the blue LED remains permanently ON, you may play music.
    - The BT module will play the audio stream from your mobile.

#### II. Selecting previously stored devices

1. Press [1] to switch ON the BT module
  - The BT module will try to connect to previously stored devices (LED flashing slowly).
  - If the last used device cannot be found, the module will skip to the previous device in the history list.
  - When a device is found, the devices will connect automatically and the LED will remain still.
2. Once the blue LED remains permanently ON, you may play music.
  - The BT module will play the audio stream from your mobile.

#### III. Adding new devices

1. Press button [3] for at least 1 second
  - The blue LED will turn to quick flashing
2. Connect to the new device following chapter „I. First time sync (new installation/reset)“
  - The BT module can store up to 8 devices. Once the list is full any new device will overwrite the device from the list which has been used the least.

#### Note:

To empty the device list you may push button [3] for at least 6 seconds.

#### Bluetooth® mode remarks

- Depending on the model, the loudspeakers on the multimedia device for playing music have been deactivated while it is connected to the BT module.
- BT module volume is independent to that from the mobile / computer.
  - It is recommended to keep the volume high in the mobile / computer to improve the usability of the BT module.
- Automatic connection
  - Only previously connected devices can connect to the BT module automatically.

### 7. TV/AUX mode

1. Press [5] to switch to TV/AUX mode.
2. Press [5] again to toggle between front and rear audio signals
  - Front input (jack), yellow LED
  - Rear input (TV LIN-RIN), green LED

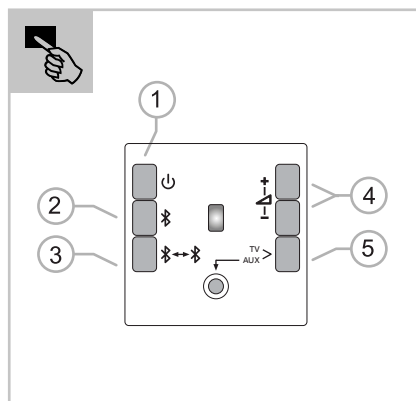

### 8. Troubleshooting

- The sound unit does not turn on.
  - Check if the sound unit is powered. A voltage between 115 and 230 V~ 50/60Hz must be applied to L and N terminals.
- The sound unit turns on, but there is no sound.
  - Check that the speakers are properly connected to L+ / L and R+ / R outputs. Verify the absence of shortcircuits and check that line impedance is above 11 Ohms. Make sure that a Bluetooth® device is connected, or a signal is present at TV or AUX inputs. Set volume level to maximum.
- The blue LED flashes slowly, but the unit does not connect to a previously paired device.
  - Check that your device has Bluetooth connectivity enabled. Press twice the ON/OFF key [1] to force a new search through the paired device list [2]. To force a pairing process, press [3] key.
- The unit is at TV or AUX mode, and there is no sound.
  - Verify that an analog signal with a level around 250-500mV is present at TV (rear terminals) or AUX (front 3.5 mm jack) inputs.

---

# Zenit Centralizations and Workstations

## Cutting-edge connectivity

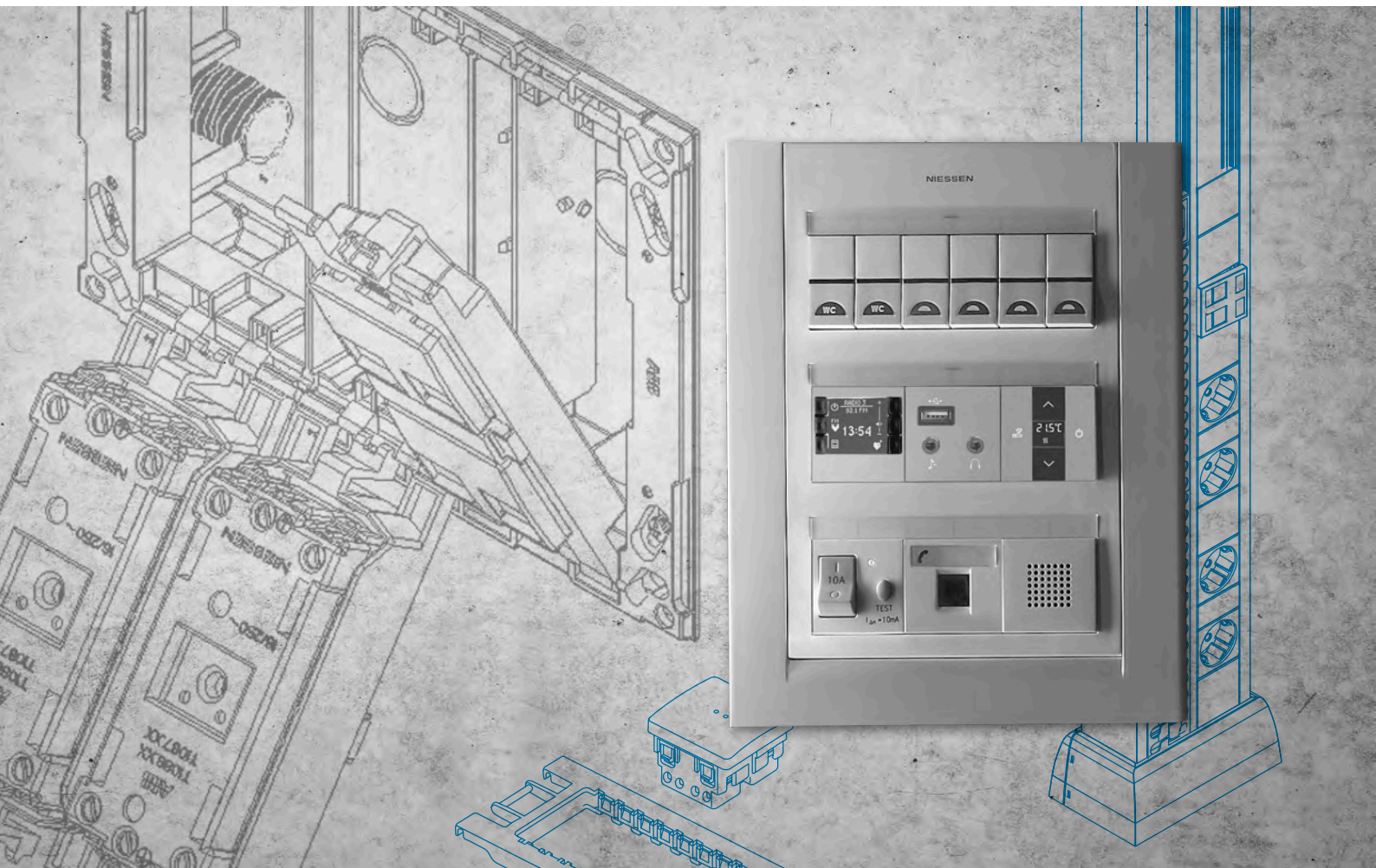

## Surface and flush-mounted Centralizations

1. For the mounting of the surface and flush mounting boxes, please check the diagrams for the Workstations in the next page.

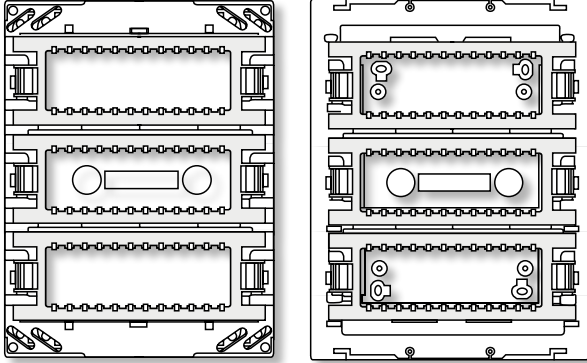

2. Both in the surface solution and in the flush solution, there are metal mounting plates where the mechanisms are inserted.

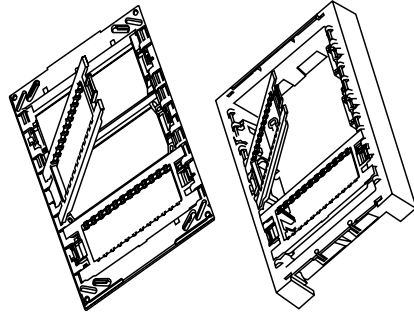

3. The mechanisms are inserted in the mounting plate by pressure.

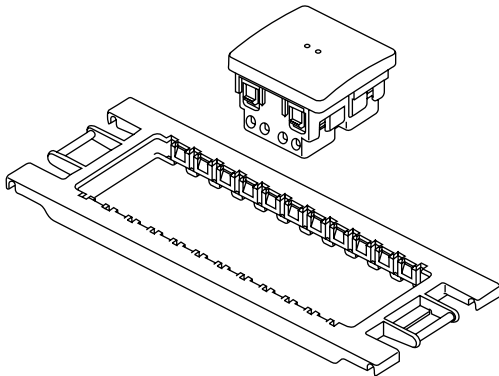

4. Once inserted, proceed with the wiring.

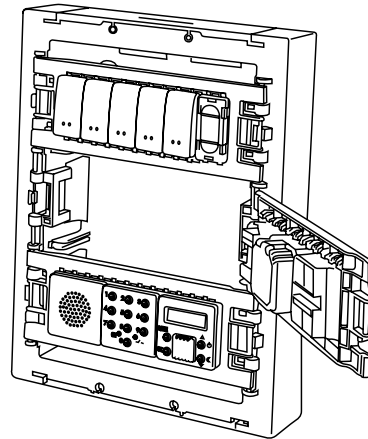

5. The mounting plate is closed by clipping.

6. Once all the devices are wired and the mounting plates correctly placed, the frame is mounted by clipping it to the box.

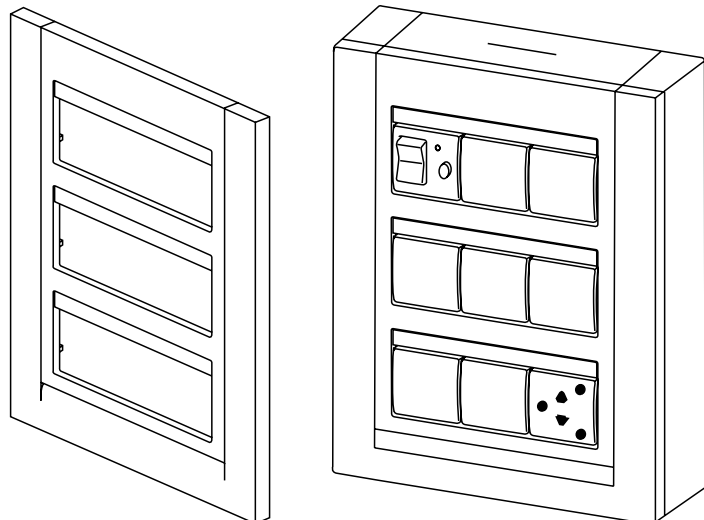

### Installation of the surface mounting boxes for Workstations

T1193, T1194, T1195

Installation of the box

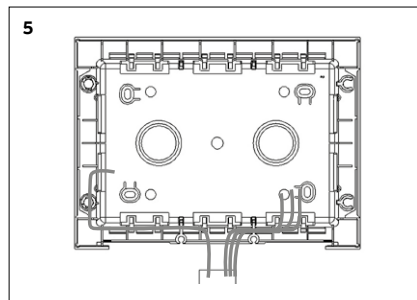
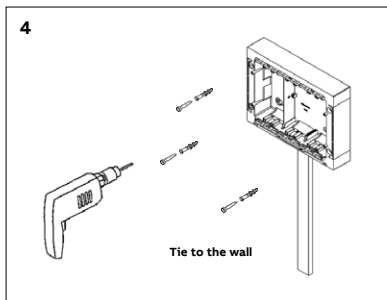
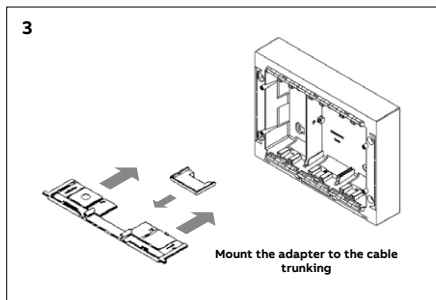
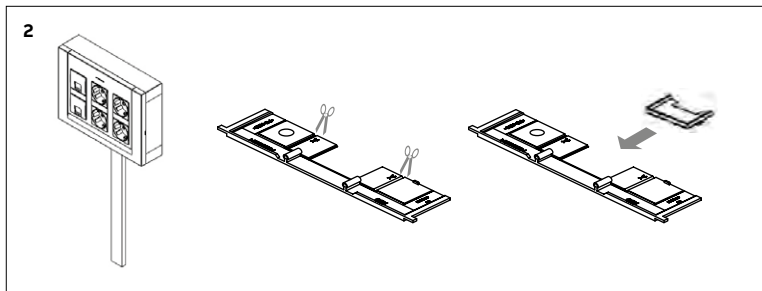
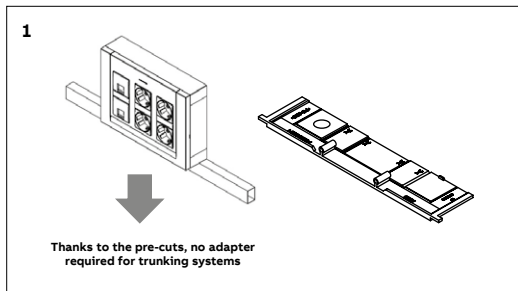
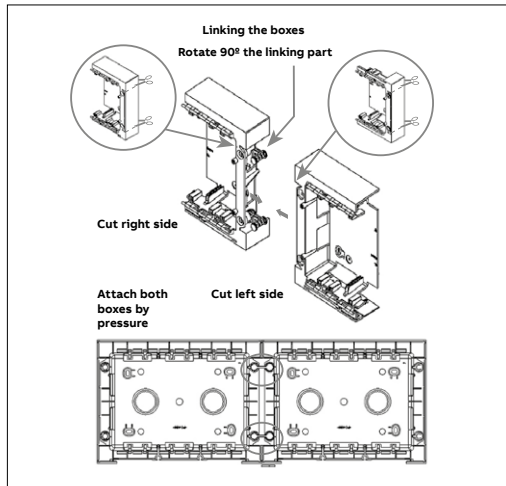
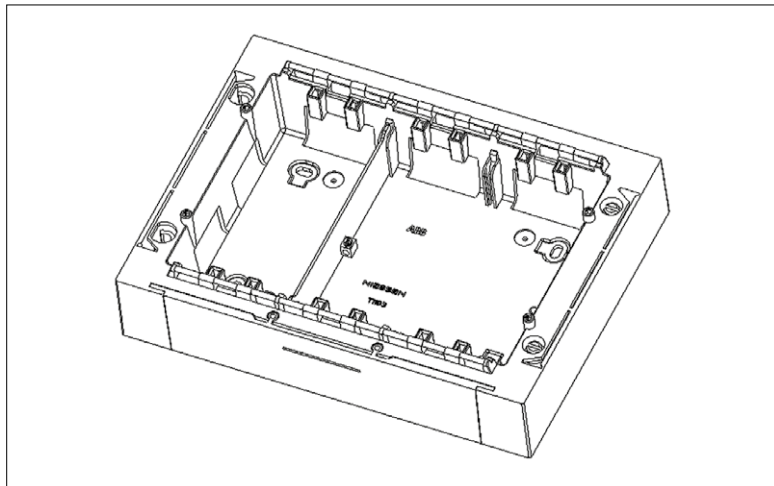

### Installation of mechanisms

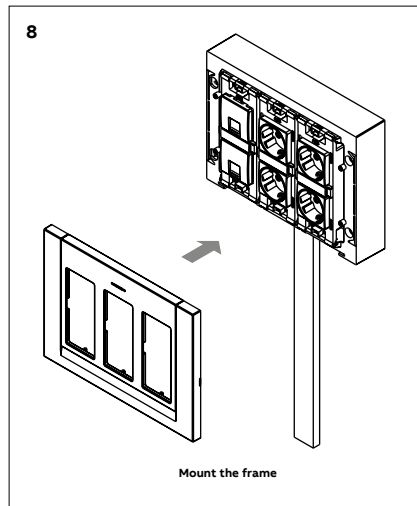
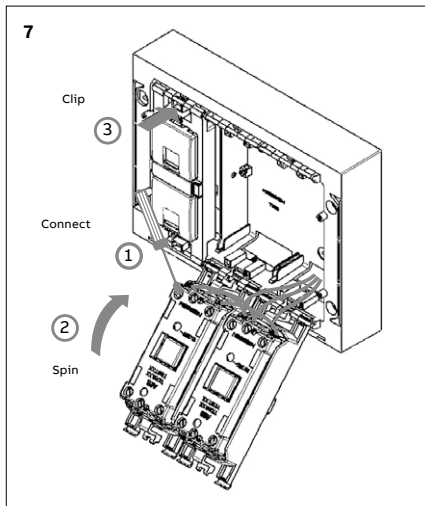
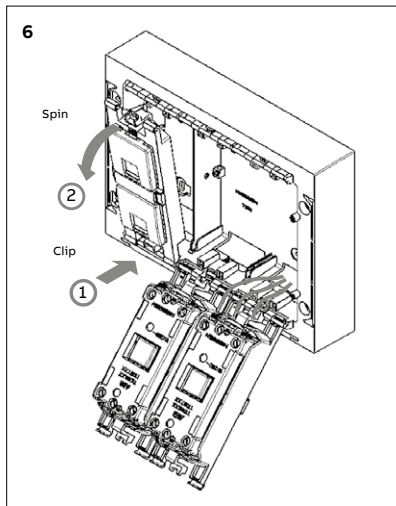

## Installation of the flush mounting boxes for Workstations

T1093, T1094

Installation in cement and brick walls

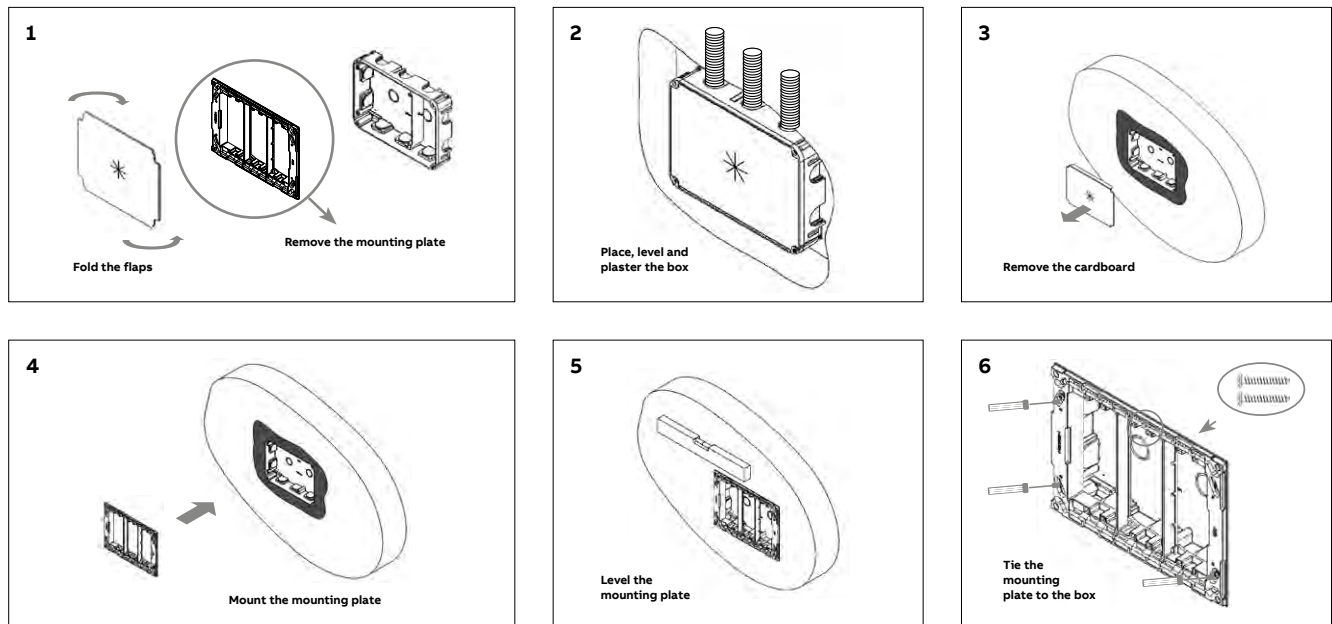

Installation in drywall / hollow partition

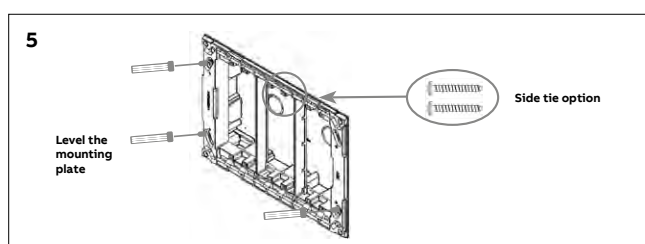
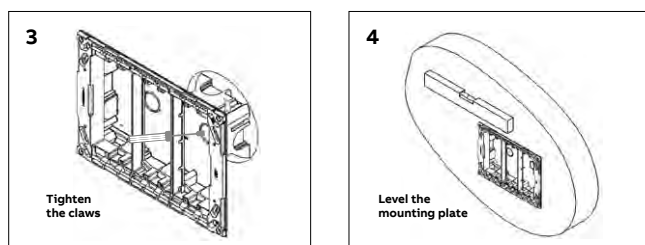
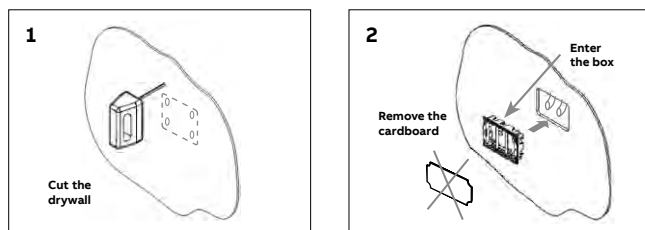
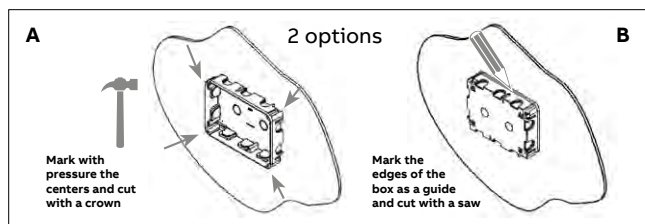

Linking the boxes in cement / brick walls

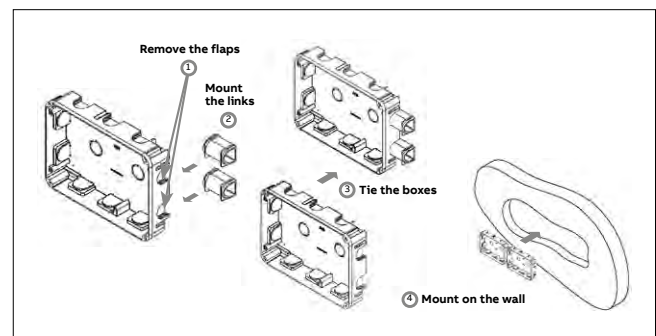

Linking the boxes in drywall / hollow partition

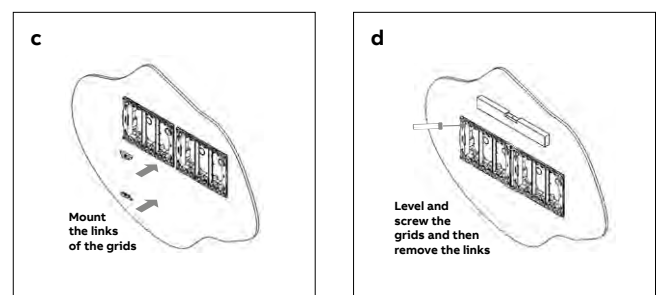
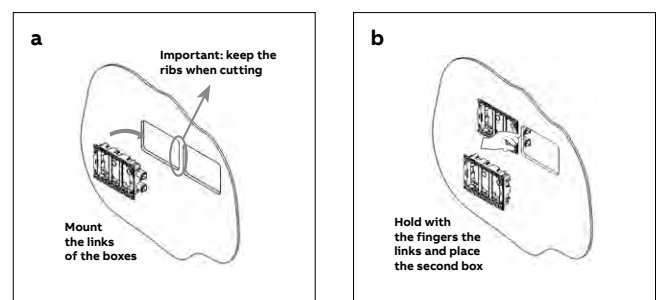

### Installation of inserts in flush mounting Workstations

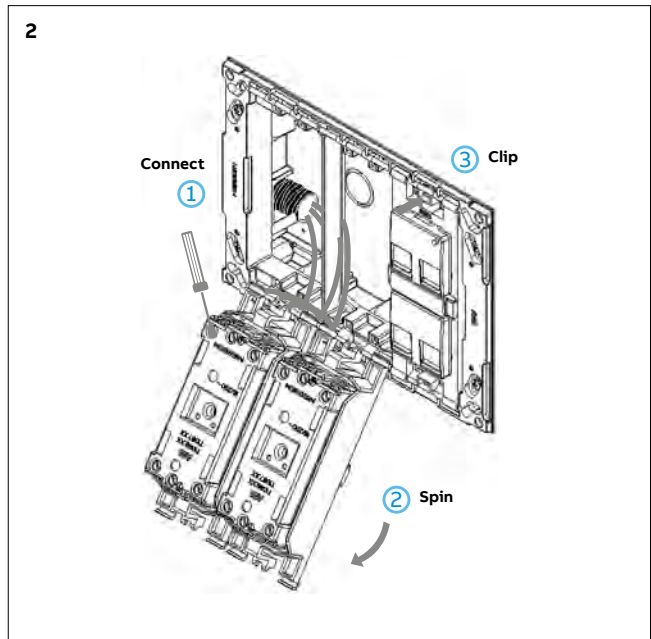
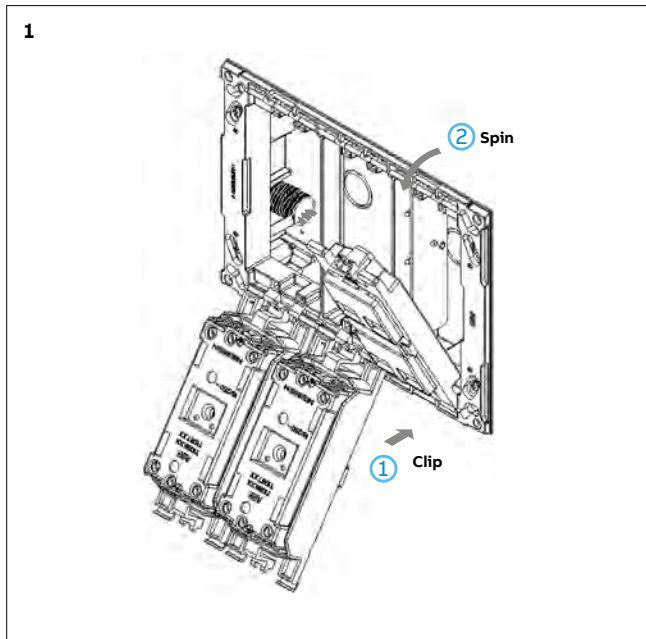

### Installation of the foldable lid in the Workstations

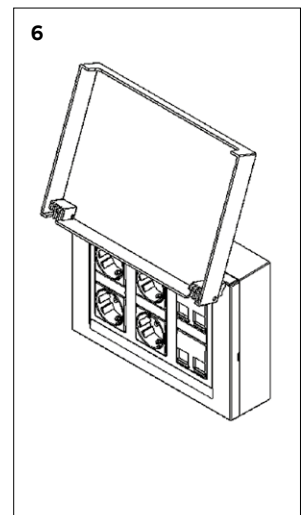
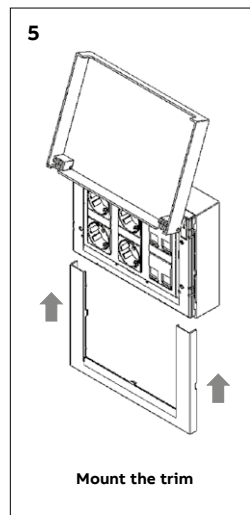
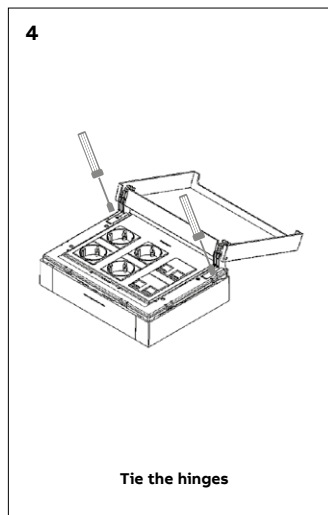
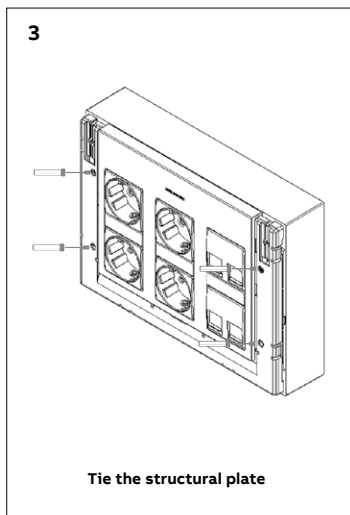
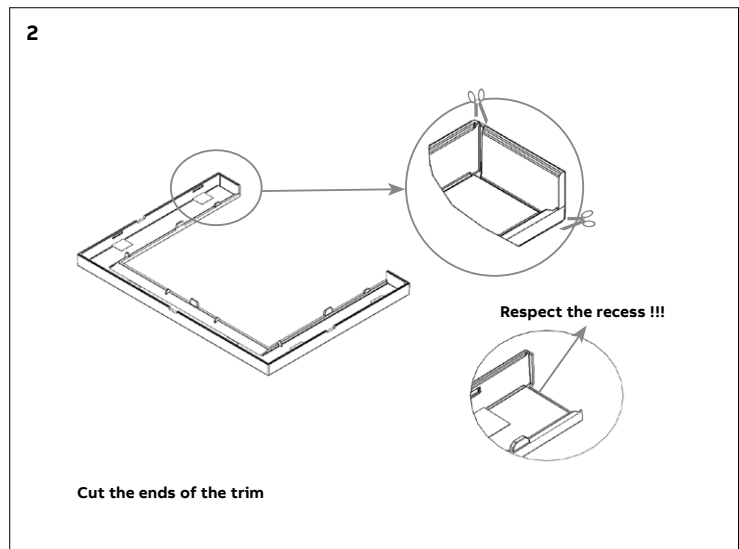
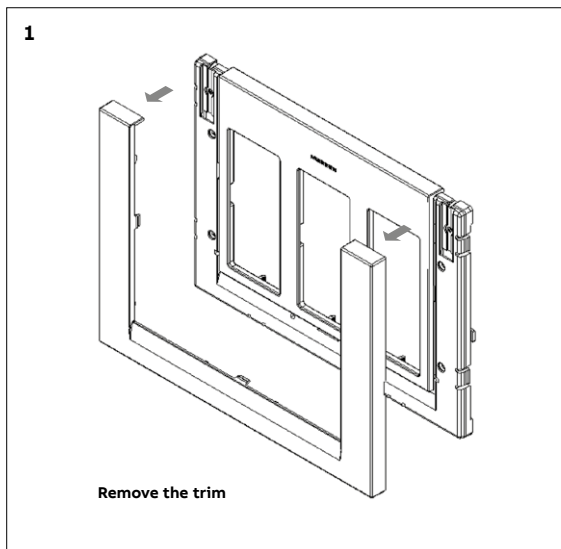



## Installation of the floor box

Installation of the frame T1373 and inserts T10XX

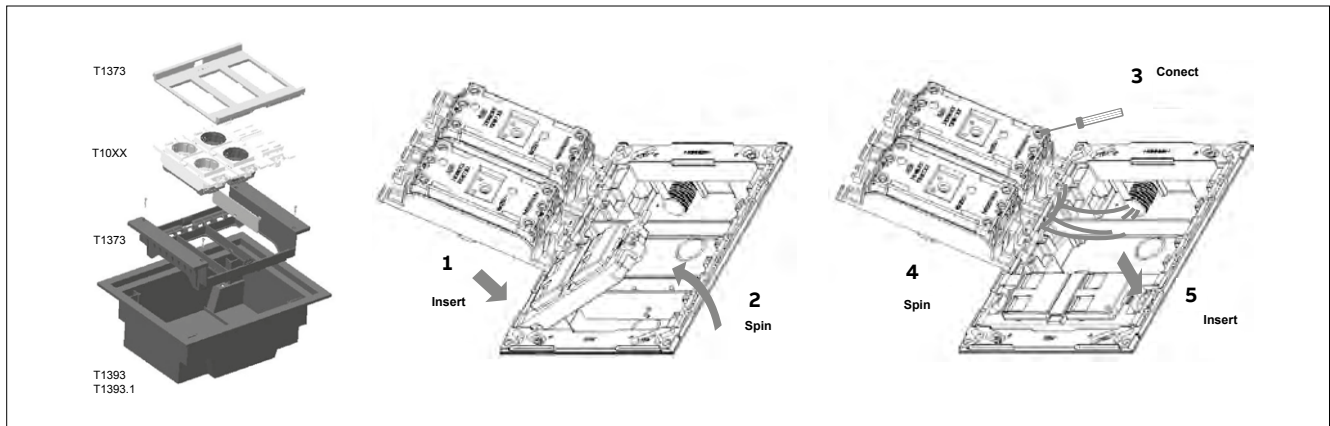

Installation in flush floor

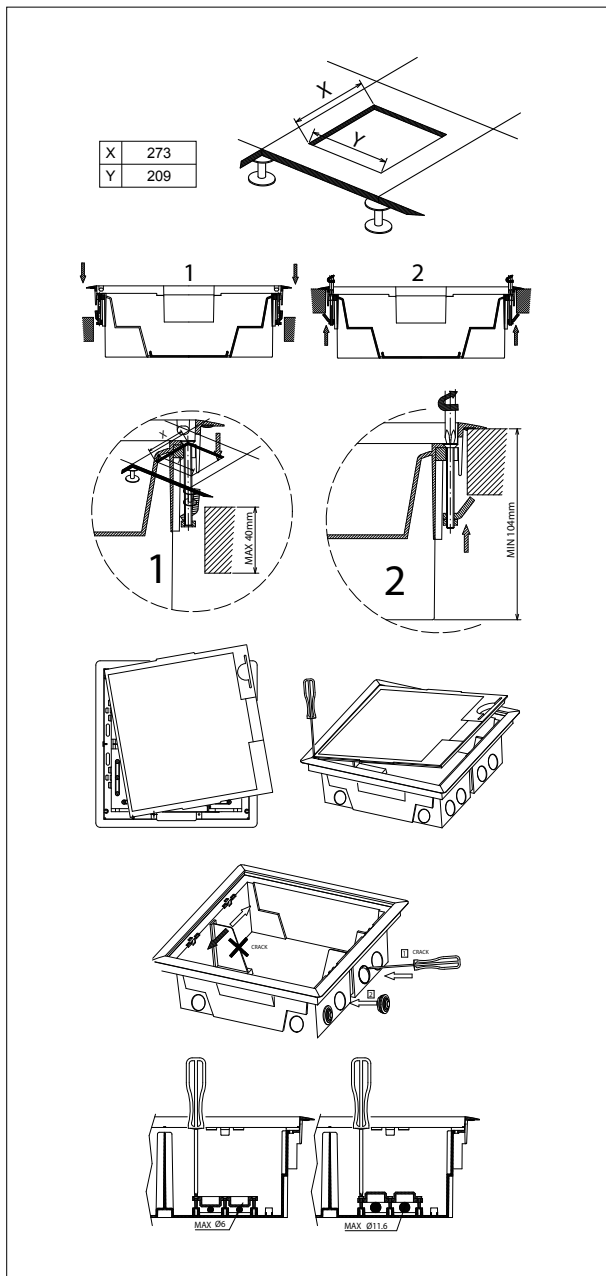

Installation of frame bracket T1393.4

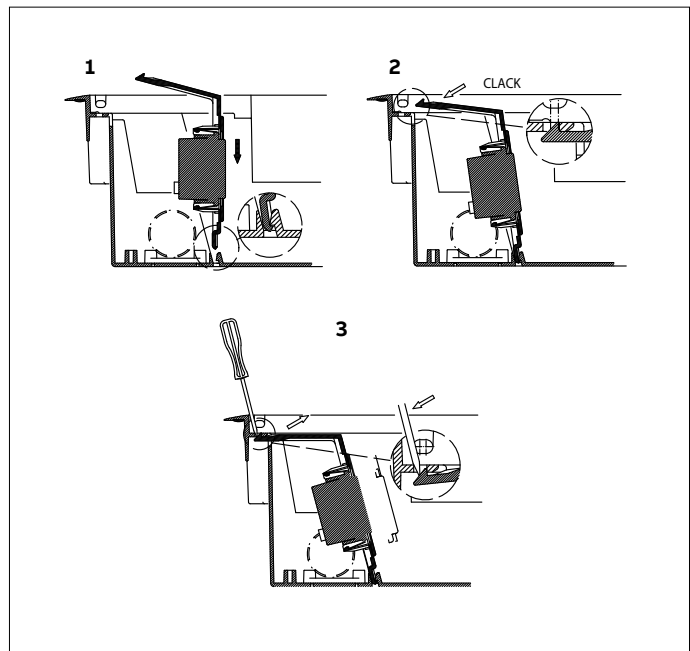

Installation in concrete floor T1393.9

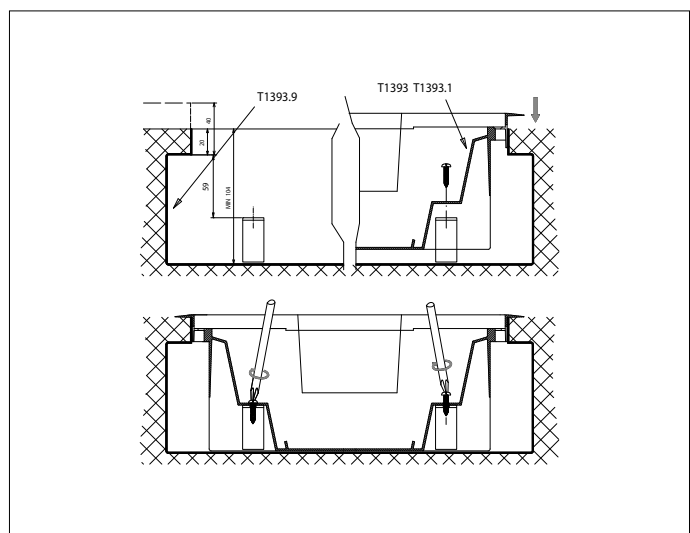

# Dimensions

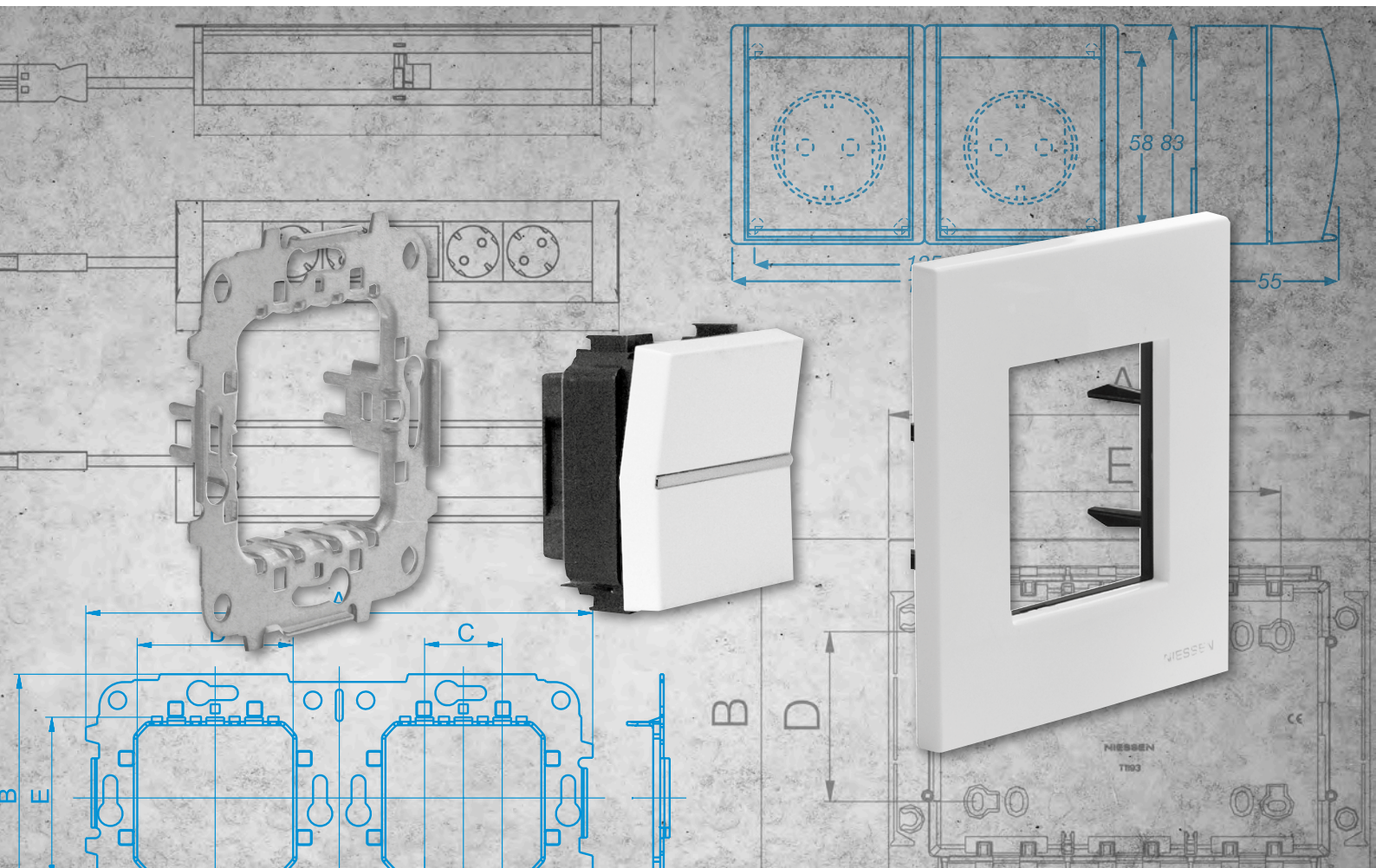

## Frames

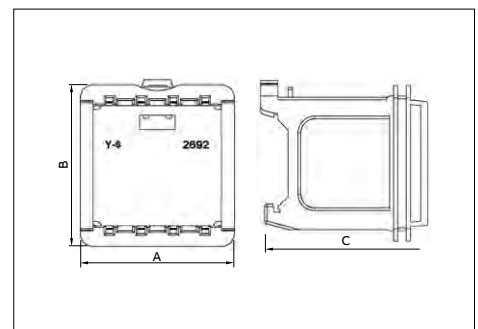
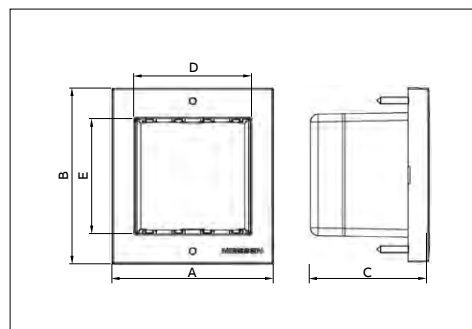
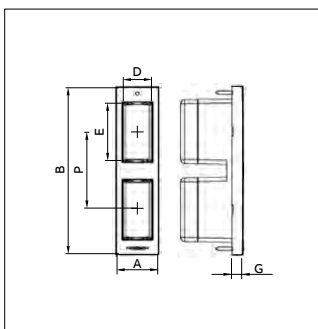
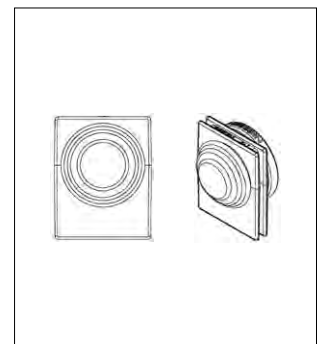
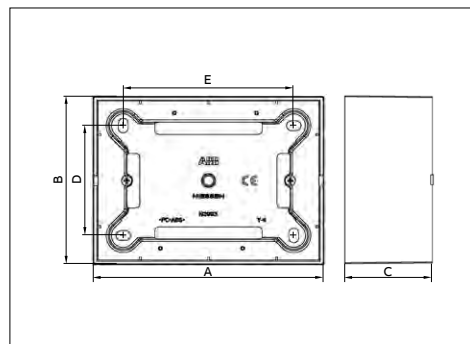
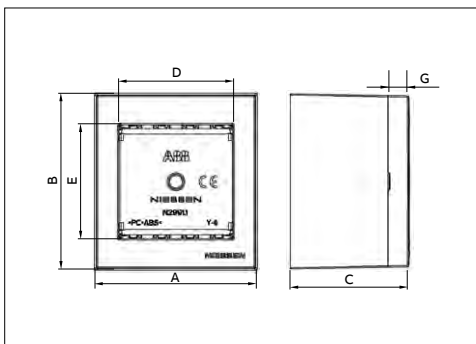
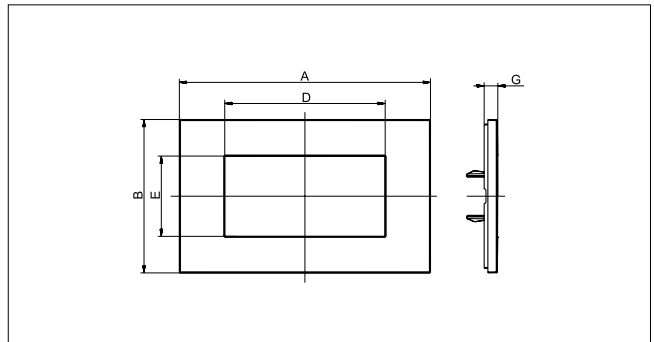
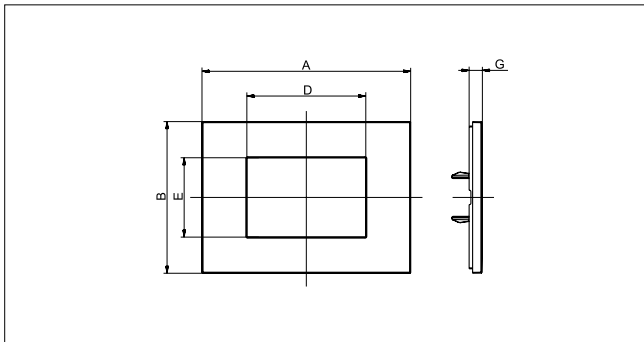
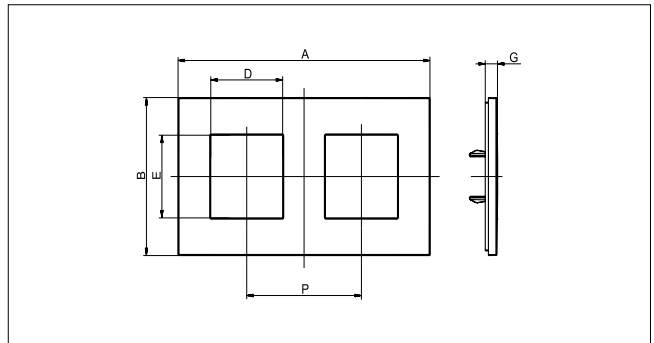
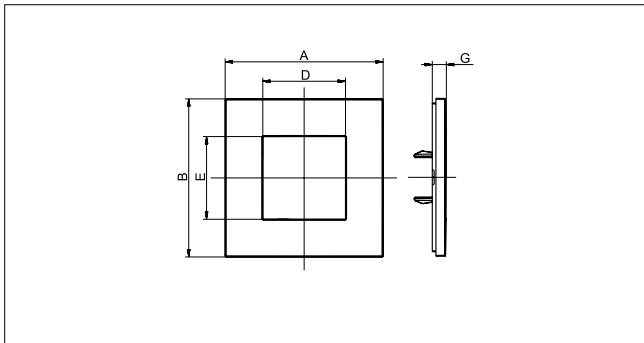
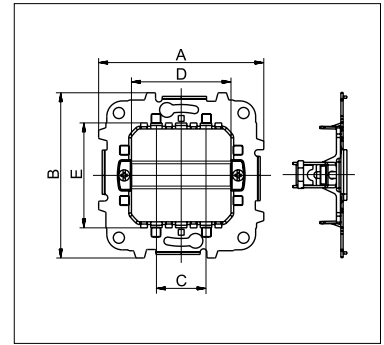
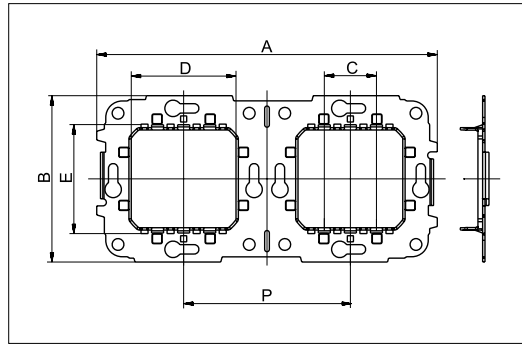
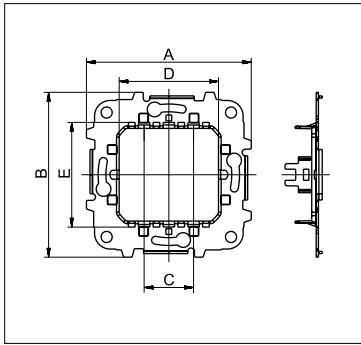

## Frames

Type	Article No.	A	B	C	D	E	G	P
Frames for square boxes (60mm screw distance)	N2171 / N2171.1 / N2271 / N2271.1	85	85	-	22,4	44,6	7,5	-
	*N2271	90	90	-	22,4	44,6	8	-
	Z2271.1	86	86	-	44,6	44,6	4,2	-
	*Z2271.1	86	86	-	44,6	44,6	4,4	-
	N2272 / N2272.1	156	85	-	44,6	44,6	7,5	71
	*N2272	161	90	-	44,6	44,6	8	71
	N2273 / N2273.1	227	85	-	44,6	44,6	7,5	71
	*N2273	232	90	-	44,6	44,6	8	71
	N2274 / N2274.1	298	85	-	44,6	44,6	7,5	71
	*N2274	303	90	-	44,6	44,6	8	71
N2275	369	85	-	44,6	44,6	7,5	71	
Frames for 3 module boxes (83,5mm screw distance)	N2370.1	122	90	-	-	-	7,5	-
	N2371.1 / N2372.2	122	90	-	22,4	44,6	7,5	-
	N2371.1V	122	90	-	44,6	22,4	7,5	-
	N2372.1	122	90	-	44,6	44,6	7,5	-
	*N2372.1 / *N2472	122	90	-	44,6	44,6	8	-
	N2373.1	122	90	-	66,8	44,6	7,5	-
	*N2373.1 / *N2473	122	90	-	66,8	44,6	8	-
	N2471 / N2472.2 / N2471.1 / N2472.3	117	85	-	22,4	44,6	7,5	-
	N2472 / N2472.1	117	85	-	44,6	44,6	7,5	-
	N2473 / N2473.1	117	85	-	66,8	44,6	7,5	-
Z2373.1	118	86	-	66,8	44,6	4,1	-	
*Z2373.1	118	86	-	66,8	44,6	4,1	-	
Frames for 4 module boxes (107mm screw distance)	N2374.1 / N2474	139	85	-	89	44,6	7,5	-
	*N2374.1 / *N2474	142	90	-	89	44,6	8	-
	Z2474.1	140	86	-	89	44,6	4,1	-
	*Z2474.1	140	86	-	89	44,6	4,1	-
Frames for 7 modules boxes (100mm screw distance)	N2777.1 / N2777	196	85	-	155,6	44,6	7,5	-
	*N2777	210	90	-	155,6	44,6	8	-
	Z2777.1	207	86	-	155,6	44,6	4,1	-
	*Z2777.1	207	86	-	155,6	44,6	4,1	-
Mounting grids	N2271.9 / N2271.9G	74	74	22,2	44,6	47	-	-
	Z2271.91	74	74	22,2	44,6	44,6	-	-
	N2272.9	145	70,8	22,2	44,6	47	-	71
	N2273.9	216	70,8	22,2	44,6	44,6	-	71
	N2371.9V	102	74	22,2	44,6	44,6	-	-
	N2473.9	102	74	22,2	66,8	44,6	-	-
	Z2373.91	102	70,8	22,2	66,8	44,6	-	-
	N2474.9	124	74	22,2	92	44,6	-	-
	Z2474.91	102	70,8	22,2	92	44,6	-	-
	N2777.9 / Z2777.91	194	79	22,2	158	44,6	-	-
Surface mounting boxes	N2991.1 BL	62	68	47	44,6	44,6	8,5	-
	8591 BL	86	86	44,2	58	58	-	-
	8592 BL	157	86	44,2	58	129	-	-
	8593 BL	228	86	44,2	58	200	-	-
	N2993 BL	117	85	44,2	56	87	-	-
	N2994 BL	139,2	85	44,2	56	110,2	-	-
Frames for profiles	N2671	32	68	46,5	22,4	44,6	8,5	-
	N2671.2	32	126	46,5	22,4	44,6	8,5	-
	N2672	62	68	46,5	44,6	44,6	8,5	-
DIN-rail mounting plate	2692 BL	53,5	56	58,5	-	-	-	-

\* Noble materials

## IP55 flush-mounting boxes

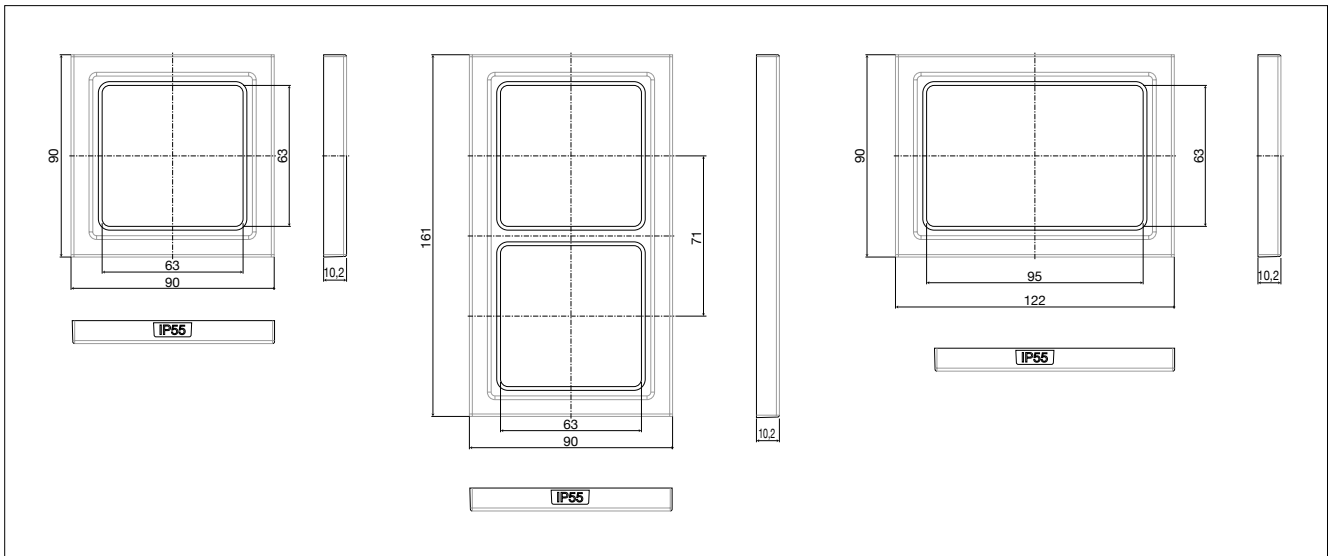

## IP55 surface mounting boxes

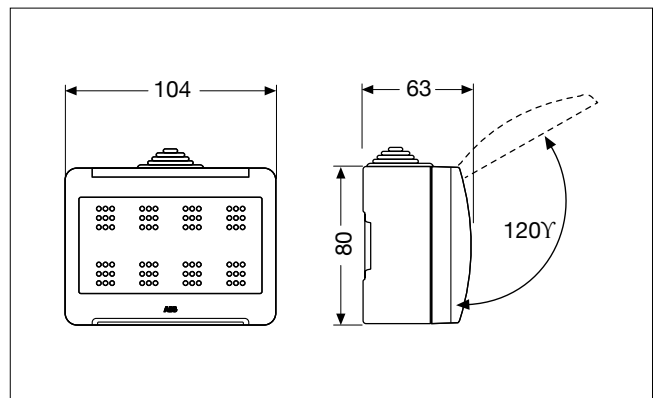
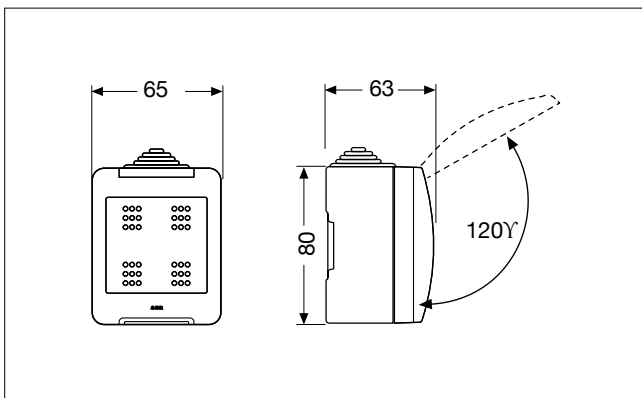

## IP40 surface mounting boxes

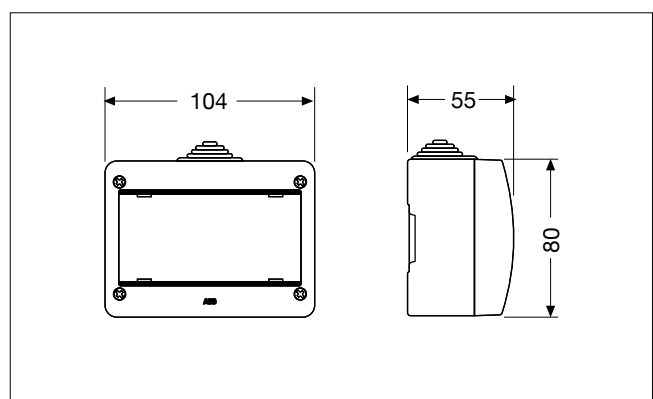
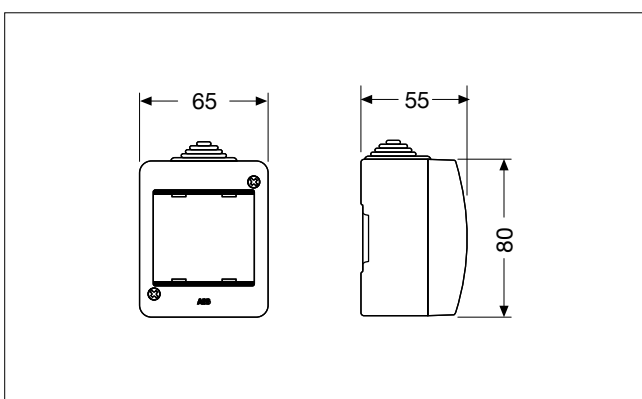

## Centralizations

**Surface mounting box**

Ref.	A	B	C	D	E
T1292	212	204	55	117	121
T1293	212	275	55	188	121
T1294	212	346	55	259	121

**Flush-mounting box**

Ref.	A	B	C	D	E
T1092.1	186	178	55	-	-
T1093.1	186	249	55	-	-
T1094.1	186	320	55	-	-

## Workstations

**Surface mounting box**

Ref.	A	B	C	D	E
T1193	235	176	45	83	146
T1194	295	176	45	83	206
T1195	355	176	45	83	266

**Flush-mounting box**

Ref.	A	B	C	D	E
T1093	211	150	42	-	-
T1094	271	150	42	-	-

## Floor boxes T1393 y T1393.1

**Floor box**

Hollow to be done: 273 x 209

**Metallic housing T1393.9**

**Adapter frame T1371.4**

**Note: all dimensions in mm.**

## Mounting boxes

1099/1199

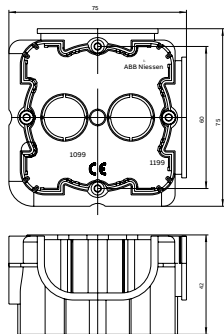

999

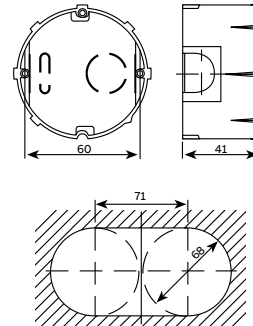

999.2

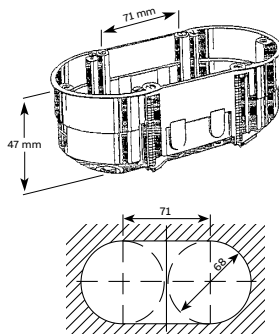

499.3

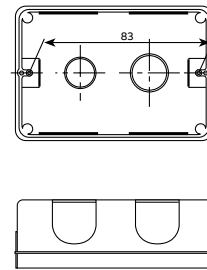

1499.4

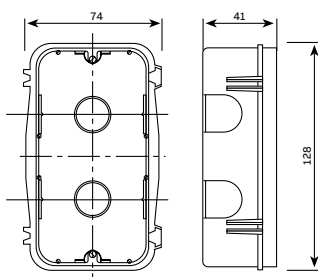

1499.7

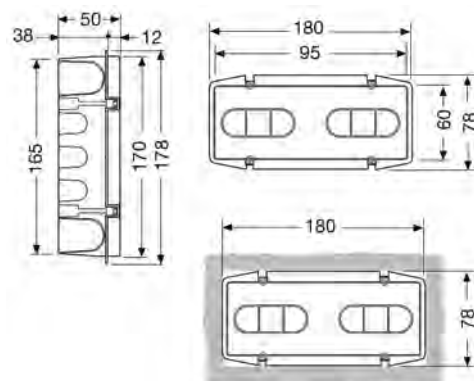

---

# Zenit

## List of products

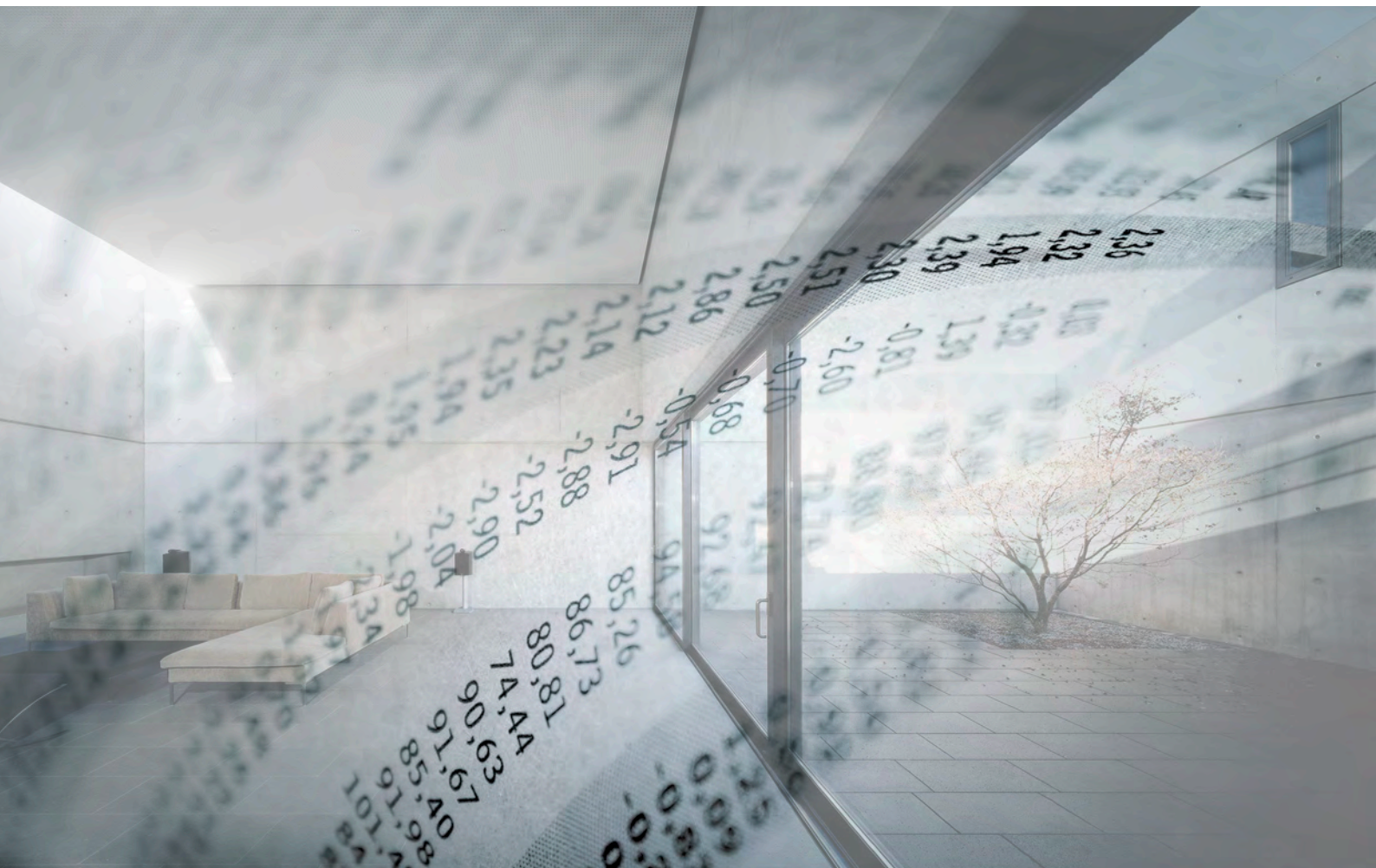



## Zenit

### List of products

Code	Finished	Pack. (unit)	Page
499.3		25	83
999		25	82
999.2		25	82
1099		10	82
1499.4		50	83
1499.7		20	83
2016		5	52
2016.1		10	52
2016.2		10	52
2016.3		10	52
6122/98-509		10	158
6123/20-500		1	158
6123/21-500		1	159
6123/22-500		1	159
6123/23-500		1	159
6123/24-500		1	159
6123/26-500		1	159
6124/98-509		1	159
6125/98-509		1	158
6126/98-509		1	158
6129/96-509		1	158
8132.1		1	158
8132.2		1	55
6129/98-509		1	158
8140.5		1	56
8150		10	48
8150.3		10	48
8150.7		10	48
8151.3		10	48
8151.7		10	48
8151.8		10	49
8225 EB		1	115
8226 EB		1	115
8226/10 EB		1	115
8152.7		10	49
8591	BL	6	85
8592	BL	5	85
8593	BL	1	85
9329		1	114
9329.1		1	115
9335.1		1	114
9368		1	112
9368.1		1	112
9368.2		1	112
9368.3		1	113
9368.4		1	113
9368.7		1	112
9399		12	115
9399.1		12	115
9399.2		12	115
9399.4	BA, NG	5	114

Code	Finished	Pack. (unit)	Page
BA-M-0.4.1		1	148
BI-F-2.0.1		1	148
BI-F-4.0.1		1	148
BI-M-4.0.1		1	148
CP-MD-N2	BL, PL,AN,CV	5	146
CP-RTC-FC-N2	BL, PL,AN,CV	5	146
CP-RTC-N2	BL, PL,AN,CV	5	146
DA-M-0.4.2		1	149
DA-M-0.4.127.1		1	149
DP4-1-611		1	147
DP4-1-625		1	147
DP4-F		1	147
DP4-T-1		1	147
DP7-S-611		1	147
DP7-S-625		1	147
FCA-M-2.3.1		1	149
HA-M-0.6.1		1	149
HA-M-0.12.1		1	149
MD-F-1.0.PB.1		1	143
MSA-F.1.1.PB.1		1	143
N2000	BL, PL,AN,CV	20	59
N2004.1		10	37
N2004.2		10	37
N2004.3		10	37
N2004.4		10	37
N2004.5		10	37
N2004.6		10	37
N2071.8		10	81
N2071.9		20	81
N2100	BL, PL,AN,CV	10	59
N2101	BL, PL,AN,CV,BB,AA	20	32
N2101.2	BL, PL,AN,CV,BB,AA	20	33
N2101.5	BL, PL,AN,CV	5	34
N2101.51	BL, PL,AN,CV	5	34
N2101.9	BL, PL,AN,CV	10	37
N2102	BL, PL,AN,CV,BB,AA	20	32
N2102.2	BL, PL,AN,CV	5	33
N2102.5	BL, PL,AN,CV	5	34
N2102.51	BL, PL,AN,CV	5	34
N2104	BL, PL,AN,CV	20	36
N2104.2	BL, PL,AN,CV	20	36
N2104.5	BL, PL,AN,CV	5	35
N2104.51	BL, PL,AN,CV	5	35
N2104.6	BL, PL,AN,CV,BB,AA	5	36
N2104.7	BL, PL,AN,CV,BB,AA	20	37
N2107	BL, PL,AN,CV	10	59
N2108	BL, PL,AN,CV	20	47
N2109	BL, PL,AN,CV	10	38
N2109.01	BL, PL,AN,CV	10	38
N2109.02	BL, PL,AN,CV	10	38
N2109.03	BL, PL,AN,CV	10	38

## Zenit

### List of products

Code	Finished	Pack. (unit)	Page
N2109.04	BL, PL,AN,CV	10	39
N2109.05	BL, PL,AN,CV	10	39
N2109.06	BL, PL,AN,CV	10	39
N2109.07	BL, PL,AN,CV	10	39
N2109.08	BL, PL,AN,CV	10	40
N2109.09	BL, PL,AN,CV	10	40
N2109.10	BL, PL,AN,CV	10	40
N2109.11	BL, PL,AN,CV	10	40
N2110	BL, PL,AN,CV,BB,AA	20	33
N2117.6	BL, PL,AN,CV	20	51
N2118.3	BL, PL,AN,CV	10	51
N2119	BL, PL,AN,CV	10	59
N2128	BL, PL,AN,CV	20	45
N2133	BL, PL,AN,CV,RJ	20	45
N2133.1	BL, PL,AN,CV,RJ	20	45
N2135	BL, PL,AN,CV	20	45
N2136	BL, PL,AN,CV,RJ	20	45
N2136.2	BL, PL,AN,CV,RJ	20	46
N2138	BL, PL,AN,CV	20	45
N2144	BL, PL,AN,CV	5	42
N2148	BL, PL,AN,CV	5	41
N2150	BL, PL,AN,CV	10	50
N2150.7	BL, PL,AN,CV	10	50
N2150.8	BL, PL,AN,CV	10	50
N2151.7	BL, PL,AN,CV	10	50
N2151.8	BL, PL,AN,CV	10	50
N2153.1	BL, PL,AN,CV	1	41
N2155.2	BL, PL,AN,CV	1	53
N2155.3	BL, PL,AN,CV	1	53
N2155.4	BL, PL,AN,CV	1	53
N2155.5	BL, PL,AN,CV	1	53
N2155.6	BL, PL,AN,CV	1	53
N2155.7	BL, PL,AN,CV	1	53
N2155.71	BL, PL,AN,CV	1	53
N2155.8	BL, PL,AN,CV	1	53
N2155.9	BL, PL,AN,CV	1	53
N2155.91	BL, PL,AN,CV	1	53
N2160.3	BL, PL,AN,CV	1	54
N2160.8	BL, PL,AN,CV	1	54
N2170	BL,AN,CV,CR,VD,TL	20	43
N2171	BL,PL,AN,CV,CB,CN,CP,C-C,CF,CH,PZ,OX,WG	20	64,65,68,69
N2171.1	BL,PL,AN,CV	20	76,77
N2180	RJ,VD	5	58
N2180.1	BL	5	58
N2180.4	BL,PL,AN,CV	5	57
N2180.5	BL,PL,AN,CV	5	57
N2185	BL,PL,AN,CV	1	46
N2185.2	BL,PL,AN,CV	1	46
N2191	BL,VD,BB	10	43

Code	Finished	Pack. (unit)	Page
N2192	RJ,NG,BB	10	43
N2192.2	BB	10	43
N2193	NG,VD,BB	20	43
N2200	BL,PL,AN,CV	20	59
N2201	BL,PL,AN,CV,BB,AA	10	32
N2201.2	BL,PL,AN,CV,BB,AA	10	33
N2201.5	BL,PL,AN,CV	5	34
N2201.51	BL,PL,AN,CV	5	34
N2201.8	BL,PL,AN,CV	5	33
N2201.9	BL,PL,AN,CV	10	37
N2202	BL,PL,AN,CV,BB,AA	10	32
N2202.5	BL,PL,AN,CV	5	34
N2202.51	BL,PL,AN,CV	5	34
N2203	BL,PL,AN,CV	10	44
N2204	BL,PL,AN,CV	10	36
N2204.2	BL,PL,AN,CV	10	36
N2204.5	BL,PL,AN,CV	5	35
N2204.51	BL,PL,AN,CV	5	35
N2204.6	BL,PL,AN,CV,BB,AA	5	36
N2204.7	BL,PL,AN,CV,BB,AA	10	37
N2204.8	BL,PL,AN,CV	10	37
N2207	BL,PL,AN,CV	10	59
N2208	BL,PL,AN,CV	10	47
N2209	BL,PL,AN,CV	10	38
N2209.01	BL,PL,AN,CV	10	38
N2209.02	BL,PL,AN,CV	10	38
N2209.03	BL,PL,AN,CV	10	38
N2209.04	BL,PL,AN,CV	10	39
N2209.05	BL,PL,AN,CV	10	39
N2209.06	BL,PL,AN,CV	10	39
N2209.07	BL,PL,AN,CV	10	39
N2209.08	BL,PL,AN,CV	10	40
N2209.09	BL,PL,AN,CV	10	40
N2209.10	BL,PL,AN,CV	10	40
N2209.11	BL,PL,AN,CV	10	40
N2210	BL,PL,AN,CV,BB,AA	10	33
N2214.1	BL,PL,AN,CV	10	41
N2214.5	BL,PL,AN,CV	1	41
N2216.1	BL,PL,AN,CV	10	52
N2216.2	BL,PL,AN,CV	10	52
N2216.3	BL,PL,AN,CV	10	52
N2216.4	BL,PL,AN,CV	10	52
N2216.5	BL,PL,AN,CV	5	52
N2216.6	BL,PL,AN,CV	5	52
N2216.7	BL,PL,AN,CV	5	52
N2216.8	BL,PL,AN,CV	5	52
N2217.6	BL,PL,AN,CV	10	51
N2219	BL,PL,AN,CV	10	59
N2221.2	BL,PL,AN,CV	1	159
N2221.4	BL,PL,AN,CV	1	159
N2221.6	BL,PL,AN,CV	1	159

## Zenit

## List of products

Code	Finished	Pack. (unit)	Page
N2221.7	BL,PL,AN,CV	1	159
N2224	BL,PL,AN,CV	1	59
N2224.1	BL,PL,AN,CV	1	59
N2233	BL,PL,AN,CV,RJ	10	44
N2229	BL,PL,AN,CV	5	114
N2234.1	BL,PL,AN,CV	1	47
N2234.2	BL,PL,AN,CV	1	47
N2234.3	BL,PL,AN,CV	1	47
N2237	BL,PL,AN,CV	10	46
N2238	BL,PL,AN,CV	10	45
N2239	BL,PL,AN,CV	10	46
N2240.3	BL,PL,AN,CV	1	56
N2240.4	BL,PL,AN,CV	1	159
N2240.5	BL,PL,AN,CV	5	56
N2241	BL,PL,AN,CV	1	55
N2241.4	BL,PL,AN,CV	1	159
N2244	BL,PL,AN,CV	5	42
N2244.1	BL,PL,AN,CV	5	42
N2144.1	BL,PL,AN,CV,BB,AA	5	42
N2244.4	BL,PL,AN,CV,BB,AA	5	57
N2244.5	BL,PL,AN,CV,BB,AA	5	57
N2248	BL,PL,AN,CV	5	41
N2250.1	BL,PL,AN,CV	20	49
N2250.7	BL,PL,AN,CV	10	50
N2250.8	BL,PL,AN,CV	20	48
N2251.3	BL,PL,AN,CV	10	49
N2251.7	BL,PL,AN,CV	10	49
N2251.8	BL,PL,AN,CV	10	49
N2252	BL,PL,AN,CV	20	49
N2253	BL,PL,AN,CV	1	41
N2253.1	BL,PL,AN,CV	1	41
N2253.2	BL,PL,AN,CV	1	41
N2254.1	BL,PL,AN,CV	1	56
N2255.1	BL,PL,AN,CV	1	114
N2257.1	BL,PL,AN,CV	1	114
N2260.3	BL,PL,AN,CV	1	54
N2260.8	BL,PL,AN,CV	1	54
N2260.9	BL,PL,AN,CV	1	54
N2261.2	BL,PL,AN,CV	1	42
N2261.21	BL,PL,AN,CV	1	42
N2262.1	BL,PL,AN,CV	1	55
N2268	BL,PL,AN,CV	1	112
N2268.3	BL,PL,AN,CV	1	113
N2268.4	BL,PL,AN,CV	1	113
N2270	VD,BL,CR,AN,CV,TL	20	43
N2271	BL,AN,PL,CV,CB,C-C,CN,CF,CP,CH,PZ,OX,WG	20/1	64,65,68,69
N2271.1	BL,PL,AN,CV	20	76,79
N2271.9		20	81
N2271.9G		20	81
Z2271.91		20	82

Code	Finished	Pack. (unit)	Page
N2272	BL,AN,PL,CV,CB,C-C,CN,CF,CP,CH,PZ,OX,WG	10	64,65,68,69
N2272.1	BL,PL,AN,CV	10	76,77
N2272.9		20	81
N2273	BL,AN,PL,CV,CB,C-C,CN,CF,CP,CH,PZ,OX,WG	5/1	64,65,68,69
N2273.1	BL,AN,PL,CV	5	76,77
N2273.9		20	81
N2274	BL,AN,PL,CV,CB,C-C,CN,CF,CP,CH,PZ,OX,WG	5/1	64,65,68,69
N2274.1	BL,AN,PL,CV	5	76,77
N2275	BL,AN,PL,CV	5	64,68
N2280	BL	1	58
N2280.4	BL,PL,AN,CV,BB,AA	5	57
N2280.2	RJ,VD	1	58
N2281	BL	1	58
N2281.1		5	58
N2285	BL,PL,AN,CV	1	46
N2287	BL,PL,AN,CV	10	44
N2287.6	BL,PL,AN,CV	10	44
N2288	BL,PL,AN,CV	10	44
N2288.1	BL,PL,AN,CV	10	44
N2288.6	BL,PL,AN,CV	10	44
N2301	BL,PL,AN,CV	10	32
N2301.9	BL,PL,AN,CV	5	37
N2302	BL,PL,AN,CV	10	32
N2304	BL,PL,AN,CV	10	36
N2310	BL,PL,AN,CV		33
N2328	BL,PL,AN,CV	20	45
N2340	BL,PL,AN,CV	1	56
N2338	BL,PL,AN,CV	20	45
N2370	BL,AN,CV	20	43
N2370.1	BL,PL,AN,CV	20	70
N2371.1	BL,PL,AN,CV	20	70
N2371.1V	BL,PL,AN,CV	20	70
N2371.9V		20	81
N2372.1	BL,PL,AN,CV,CB,CN,PZ,OX,WG	20/2	70,71
N2372.2	BL,PL,AN,CV	20	70
N2373.1	BL,PL,AN,CV,CB,CN,CP,C-C,CF,CH,PZ,OX,WG	20/2	70,71
Z2373.91		20	82
N2374.9		20	81
N2374.1	BL,PL,AN,CV,CB,CN,PZ,OX,WG	10/2	70,71
N2471	BL,PL,AN,CV	20	66
N2472	BL,PL,AN,CV,CB,CN,CC,CF,CH	20/2	66
N2472.2	BL,PL,AN,CV	20	66
N2473	BL,PL,AN,CV,CB,CN,CP,C-C,CF,CH,PZ,OX,WG	20/2	66,67
N2474	BL,PL,AN,CV,CB,CN,CP,C-C,CF,CH,PZ,OX,WG	10/2	66,67
Z2474.1	BL,CB,CN	10	79
N2474.9		20	81
Z2474.91		20	82

## Zenit

### List of products

Code	Finished	Pack. (unit)	Page
N2573	BL,PL,AN,CV	20	73
N2573.9		20	81
N2670	BL,PL,AN,CV	5	72
N2671	BL,PL,AN,CV	10	83
N2671.1	BL,PL,AN,CV	5	72
N2671.2	BL,PL,AN,CV	5	83
N2672	BL,PL,AN,CV	6	83
N2672.2	BL,PL,AN,CV	5	72
N2672.4	BL,PL,AN,CV	5	72
N2673.6	BL,PL,AN,CV,CB,CN,PZ,OX,WG	5/2	72
N2673.9		10	81
N2692	BL	10	83
N2777	CB,CN,CP,CF,CH	5/1	66,67,71
Z2777.91		20	82
N2777.1	BL,PL,AN,CV	5	70
N2777.9		20	81
N2801	BL,PL,AN,CV	10	32
N2802	BL,PL,AN,CV	10	32
N2810	BL,PL,AN,CV	10	33
N2870	BL,AN,CV	20	43
N2991.1	BL	10	85
N2993	BL	10	85
N2994	BL	5	85
N2999	BL	10	85
N3002		10	86
N3004		10	86
N3088		10	86
N3202		10	87
N3204		10	87
N3271	BL,GR,AN	10	86
N3272	BL,GR,AN	5	86
N3373	BL,GR,AN	5	86
N3288		10	87
N3291		10	87
N3291.1		10	85
N3292		10	87
N3292.1		10	85
N3293		5	87
N3293.1		5	85
N3391		10	87
N3391.1		10	85
PS-M-64.1.1		1	147
RTC-F-1.PB		1	143
RTC-F-1.PB-WL		1	145
RTC-F-2.1-1.PB-WL		1	145
SA-M-0.4.1		1	148
SA-M-8.8.1		1	148
SAP/S.3		1	147
SAP-1-WL		1	147
SBA-F-1.1.PB.1		1	143

Code	Finished	Pack. (unit)	Page
SBA-F-1.1.PB.1-WL		1	145
SBA-F-2.1.PB.1		1	143
SBA-F-2.1.PB.1-WL		1	145
SBB-N2	BL,GR	20	146
SBD-N2	BL,GR	20	146
SBL-N2	BL,GR	20	146
SBS-N2	BL,GR	20	146
SDA-F-1.1.PB.1		1	142
SDA-F-1.1.PB.1-WL		1	144
SDA-F-2.1.PB.1		1	142
SDA-F-2.1.PB.1-WL		1	144
SR-2-N2	BL,PL,AN,CV	5	146
SR-4-N2	BL,PL,AN,CV	5	146
SSA-F-1.1.PB.1		1	142
SSA-F-1.1.PB.1-WL		1	144
SSA-F-2.1.PB.1		1	142
SSA-F-2.1.PB.1-WL		1	144
SSA-F-2.2.PB.1		1	142
SSA-F-2.2.PB.1-WL		1	144
SU-F-1.0.PB.1		1	142
SU-F-1.0.PB.1-WL		1	144
SU-F-2.0.PB.1		1	142
SU-F-2.0.PB.1-WL		1	144
MSA-F-1.1.1-WL		1	145
T1000		10	105
T1016.1	BL,PL	10	105
T1016.2	BL,PL	10	105
T1016.3	BL,PL	10	105
T1016.4	BL,PL	10	105
T1016.5	BL,PL	5	105
T1016.6	BL,PL	5	105
T1016.7	BL,PL	5	105
T1016.8	BL,PL	10	105
T1034	BL,PL	10	105
T1087	BL,RJ	5	104
T1088	BL,PL,RJ,RP	5	104
T1092.1		1	94
T1093		1	102
T1093.1		1	94
T1094		1	102
T1094.1		1	94
T1173	BL,PL	1	103
T1173.5		1	103
T1174	BL,PL	1	103
T1174.5		1	103
T1175		1	103
T1175.5		1	103
T1193	BL,PL	1	102
T1194	BL,PL	1	102
T1195	BL,PL	1	102
T1272	BL,BP,PL,AN	1	95

Code	Finished	Pack. (unit)	Page
T1273	BL,BP,PL,AN	1	95
T1274	BL,BP,PL,AN	1	95
T1292	BL,PL,AN	1	94
T1293	BL,PL,AN	1	94
T1294	BL,PL,AN	1	94
T1371.4		6	104
T1373		20	104
T1393		1	104
T1393.1		1	104
T1393.9		1	104
WS-1		1	147







---

**Asea Brown Boveri, S.A.**

**Fábrica Niessen**

Pol. Ind. de Aranguren, 6

20180 OIARTZUN

Spain

Tel.: +34 943 260 101

Fax: +34 943 260 240

[abb.es/niessen](http://abb.es/niessen)